

# Alpha<sup>®</sup> Sign Communications Protocol

Revision F

## Contents

1.0 Contents .....	3
2.0 Introduction .....	6
3.0 Document information .....	6
4.0 Protocol overview .....	7
5.0 Transmission packet formats .....	9
5.1 Standard transmission packet ("1-byte" or "A") format .....	10
5.2 ASCII Printable formats .....	15
6.0 Command Codes .....	17
6.1 TEXT file commands .....	17
6.2 SPECIAL FUNCTION commands .....	21
6.3 STRING file commands .....	37
6.4 SMALL DOTS PICTURE file commands .....	39
6.5 LARGE DOTS PICTURE file commands .....	42
6.6 RGB DOTS PICTURE file commands .....	44
6.7 ALPHAVISION BULLETIN MESSAGE file commands .....	48
7.0 Appendices .....	50
7.1 Appendix A: Valid File Labels .....	50
7.2 Appendix B: Valid Start and Stop times .....	51
7.3 Appendix C: Counter information .....	52
7.4 Appendix D: STRING file notes .....	53
7.5 Appendix E: Sample programs .....	56
7.6 Appendix F: Protocol examples .....	58
7.7 Appendix G: Alpha protocol ASCII table .....	81
7.8 Appendix H: ISO ASCII table .....	88
7.9 Appendix I: Modes, fonts, colors, and display options available on signs .....	89
7.10 Appendix J: Position rules for signs .....	94
7.11 Appendix K: Pass Through Command Examples .....	101
7.12 Appendix L: Network cabling and sign connector pinouts .....	103
7.13 Appendix M: Alpha 2.0 protocol additions .....	107
7.14 Appendix N: Alpha 3.0 protocol additions .....	132
7.15 Appendix O: Font character sets .....	141

This document explains how to use the Alpha sign communications protocol to send messages and graphics to Alpha signs.

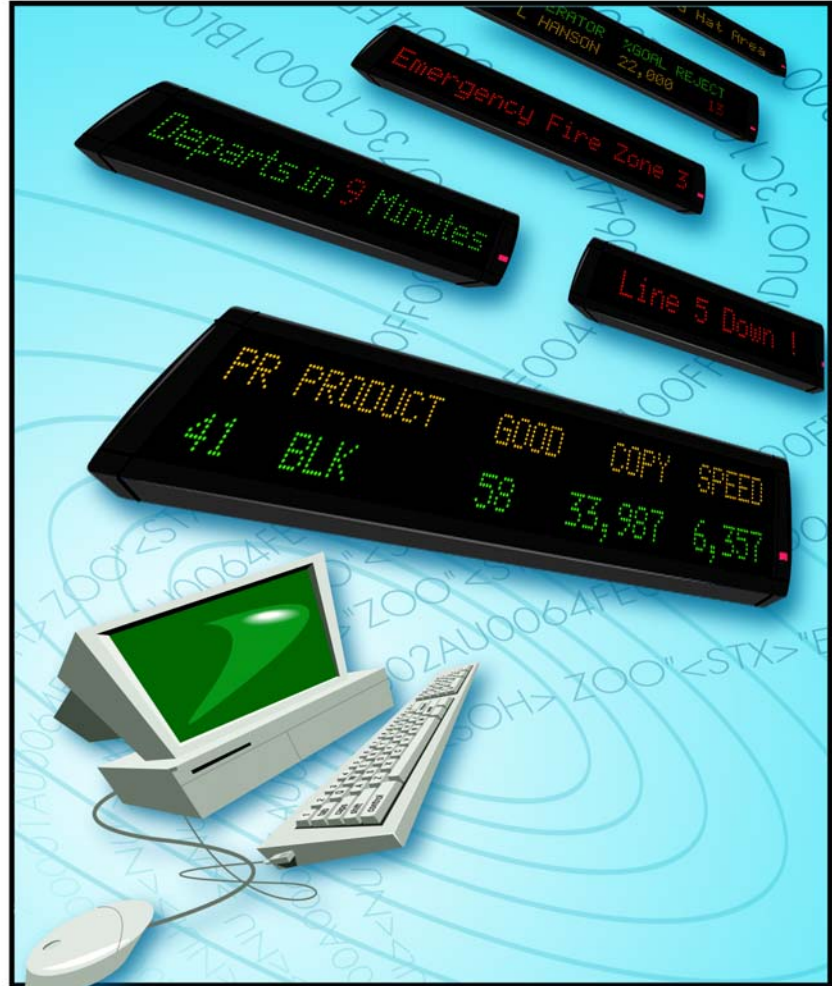

This manual is copyrighted. No part of this manual may be copied, reproduced, distributed, resold, translated, or reduced to any electronic medium or machine-readable form without the prior written consent of Adaptive Micro Systems, Inc.

For protocol examples, go to Adaptive's FTP site:  
[ftp://ftp.ams-i.com/alpha\\_protocol\\_examples/](ftp://ftp.ams-i.com/alpha_protocol_examples/)

**ADAPTIVE**  
*Connecting people, places and ideas*



© Copyright 1995 - 2006 Adaptive Micro Systems, Inc. All rights reserved.  
Adaptive Micro Systems • 7840 North 86th Street • Milwaukee, WI 53224 USA • 414-357-2020 • 414-357-2029 (fax) • <http://www.adaptivedisplays.com>  
The following are trademarks of Adaptive Micro Systems: Adaptive, Alpha, AlphaNet plus, AlphaEclipse, AlphaEclipse RoadStar, AlphaEclipse StreetSmart, AlphaPremiere, AlphaTicker, AlphaVision, AlphaVision InfoTracker, Automode, BetaBrite, BetaBrite Director, BetaBrite Messaging Software, BetaBrite Prism, Big Dot, PPD, Smart Alec, Solar, TimeNet.  
The distinctive trade dress of this product is a trademark claimed by Adaptive Micro Systems, Inc.  
Due to continuing product innovation, specifications in this manual are subject to change without notice.

**NOTE:** Due to continuing product innovation, specifications in this document are subject to change without notice.

Trademarked names appear throughout this document. Rather than list the names and entities that own the trademarks or insert a trademark symbol with each mention of the trademarked name, the publisher states that it is using the names for editorial purposes and to the benefit of the trademark owner with no intention of improperly using the trademark.

Visit our Internet World Wide Web site: <http://www.adaptivedisplays.com>

# 1.0 Contents

- 2.0 Introduction . . . . . 6**
- 3.0 Document information . . . . . 6**
  - 3.1 Revision history . . . . . 6
  - 3.2 Document conventions . . . . . 7
- 4.0 Protocol overview . . . . . 7**
  - 4.1 Displaying text . . . . . 7
  - 4.2 Displaying graphics . . . . . 7
  - 4.3 Special functions . . . . . 7
  - 4.4 Protocol version comparison . . . . . 8
- 5.0 Transmission packet formats . . . . . 9**
  - 5.1 Standard transmission packet (“1-byte” or “^A”) format . . . . . 10
    - 5.1.1 Checksum format . . . . . 12
    - 5.1.2 Nesting with Checksums format . . . . . 13
    - 5.1.3 Nesting without Checksums format . . . . . 14
  - 5.2 ASCII Printable formats . . . . . 15
    - 5.2.1 ASCII Printable “2-byte” code . . . . . 15
    - 5.2.2 ASCII Printable “3-byte” code . . . . . 16
- 6.0 Command Codes . . . . . 17**
  - 6.1 TEXT file commands . . . . . 17
    - 6.1.1 Write TEXT file Command Code — “A” (41H) . . . . . 18
    - 6.1.2 Read TEXT file Command Code — “B” (42H) . . . . . 19
    - 6.1.3 Priority TEXT files . . . . . 20
  - 6.2 SPECIAL FUNCTION commands . . . . . 21
    - 6.2.1 Write SPECIAL FUNCTION Command Code — “E” (45H) . . . . . 21
    - 6.2.2 Read SPECIAL FUNCTION Command Code — “F” (46H) . . . . . 29
  - 6.3 STRING file commands . . . . . 37
    - 6.3.1 Write STRING file Command Code — “G” (47H) . . . . . 37
    - 6.3.2 Read STRING file Command Code — “H” (48H) . . . . . 38
  - 6.4 SMALL DOTS PICTURE file commands . . . . . 39
    - 6.4.1 Write SMALL DOTS PICTURE file Command Code — “I” (49H) . . . . . 39
    - 6.4.2 Read SMALL DOTS PICTURE file Command Code — “J” (4AH) . . . . . 41
  - 6.5 LARGE DOTS PICTURE file commands . . . . . 42
    - 6.5.1 Write LARGE DOTS PICTURE file Command Code — “M” (4DH) . . . . . 42
    - 6.5.2 Read LARGE DOTS PICTURE file Command Code — “N” (4EH) . . . . . 43
  - 6.6 RGB DOTS PICTURE file commands . . . . . 44
    - 6.6.1 Write RGB DOTS PICTURE file Command Code — “K” (4BH) . . . . . 44
    - 6.6.2 Read RGB DOTS PICTURE file Command Code — “L” (4CH) . . . . . 46
    - 6.6.3 RGB color chart . . . . . 47
  - 6.7 ALPHAVISION BULLETIN MESSAGE file commands . . . . . 48
    - 6.7.1 Write ALPHAVISION BULLETIN MESSAGE file Command Code — “O” (4FH) . . . . . 48
    - 6.7.2 Stop ALPHAVISION BULLETIN MESSAGE file Command Code — “OT” (4F + 54H) . . . . . 49

<b>7.0 Appendices</b>	<b>50</b>
7.1 Appendix A: Valid File Labels	50
7.2 Appendix B: Valid Start and Stop times	51
7.3 Appendix C: Counter information	52
7.3.1 Displaying Counter values	52
7.3.2 Setting up Counters	52
7.4 Appendix D: STRING file notes	53
7.4.1 Advantages of using STRING files	53
7.4.2 Using STRING files example	53
7.5 Appendix E: Sample programs	56
7.5.1 Sample Visual BASIC program	56
7.6 Appendix F: Protocol examples	58
7.6.1 Standard transmission packet examples	58
7.6.2 Transmission packet with Checksum example	60
7.6.3 Nesting with checksums transmission packet example	61
7.6.4 Nesting without Checksum transmission packet example	62
7.6.5 Multiple Type Codes / Sign Addresses example	63
7.6.6 TEXT file examples	64
7.6.7 Priority TEXT file examples	68
7.6.8 SPECIAL FUNCTION examples	69
7.6.9 STRING file examples	74
7.6.10 DOTS PICTURE file examples	76
7.6.11 Displaying text at XY position examples	77
7.7 Appendix G: Alpha protocol ASCII table	81
7.7.1 Standard character set (00 –7FH)	81
7.7.2 Extended character set (80 - C1H)	84
7.8 Appendix H: ISO ASCII table	88
7.9 Appendix I: Modes, fonts, colors, and display options available on signs	89
7.9.1 Standard Modes	89
7.9.2 Special Modes	89
7.9.3 Special Graphics	90
7.9.4 Modes available on signs	91
7.9.5 Fonts and colors available on signs	92
7.9.6 Display options available on signs	93
7.10 Appendix J: Position rules for signs	94
7.10.1 Sign classes	94
7.10.2 Position classes	94
7.10.3 Position rule examples	94
7.11 Appendix K: Pass Through Command Examples	101
7.11.1 Read Turbo Adapter Version and Build Number (AlphaEclipse 3600 only)	101
7.11.2 Read Light Sensor	101
7.11.3 Write Turbo Adapter MUX Control Command (channel 1)	102
7.12 Appendix L: Network cabling and sign connector pinouts	103
7.12.1 Network cabling pinouts	103
7.12.2 Sign connector pinouts	105
7.13 Appendix M: Alpha 2.0 protocol additions	107
7.13.1 Speed control	107
7.13.2 Sound control (AlphaPremiere 9000 only)	108
7.13.3 Set Run File Time	110
7.13.4 Custom character sets	114
7.13.5 Automode table	117
7.13.6 Set Timeout Message	118

- 7.13.7 Dimming Control Register . . . . . 118
- 7.13.8 Enable/Disable ACK/NAK response . . . . . 121
- 7.13.9 Temperature Logging . . . . . 122
- 7.13.10 Read External Temperature command . . . . . 125
- 7.13.11 Read Internal Temperature command . . . . . 126
- 7.13.12 Set Unit commands . . . . . 128
- 7.13.13 Read Dim Times command . . . . . 130
- 7.14 Appendix N: Alpha 3.0 protocol additions . . . . . 132
  - 7.14.1 Additions to Set Unit commands . . . . . 134
  - 7.14.2 Read Over-Temp Flag Command . . . . . 137
  - 7.14.3 Read Compact Flash Status Command . . . . . 137
  - 7.14.4 Read Message Tracking Command . . . . . 138
  - 7.14.5 Clear Message Time Tracking Command . . . . . 138
  - 7.14.6 Turn ON/OFF Periodic Sampling Command . . . . . 138
  - 7.14.7 RGB Set Color in Text Attribute . . . . . 139
  - 7.14.8 RGB GIF protocol (RGB Dot Additions) . . . . . 139
  - 7.14.9 Write/Read Serial Number . . . . . 140
- 7.15 Appendix O: Font character sets . . . . . 141
  - 7.15.1 5-High Regular (SS5) . . . . . 141
  - 7.15.2 7-High Regular (SS7) . . . . . 143
  - 7.15.3 7-High Fancy (SF7) . . . . . 150
  - 7.15.4 7-High True Descender Regular . . . . . 157
  - 7.15.5 7-High True Descender Fancy . . . . . 157
  - 7.15.6 7-High Fat Character . . . . . 158
  - 7.15.7 8-High Regular (SS8) . . . . . 158
  - 7.15.8 8-High Fancy (SF8) . . . . . 166
  - 7.15.9 10-High Fancy (SF10) . . . . . 175
  - 7.15.10 10-High True Descender Fancy . . . . . 181
  - 7.15.11 15-High Regular (SS15) . . . . . 182
  - 7.15.12 15-High Fancy (SF15) . . . . . 190
  - 7.15.13 15-High True Descender Regular . . . . . 198
  - 7.15.14 15-High True Descender Fancy . . . . . 199
  - 7.15.15 15-High Fat Character . . . . . 199
  - 7.15.16 16-High Regular (SS16) . . . . . 200
  - 7.15.17 16-High Fancy (SF16) . . . . . 208
  - 7.15.18 16-High Fat Character . . . . . 216

## 2.0 Introduction

This document is designed to allow a user to understand how to communicate with the Alpha line of electronic signs manufactured by Adaptive Micro Systems. The signs must have the Alpha firmware (EPROM) installed.

There are four versions of protocol with which you can communicate with a Alpha sign (see Table 3, "Protocol version comparison," on page 8):

- EZ KEY II
- Alpha 1.0 (EZ95)
- Alpha 2.0
- Alpha 3.0

These protocols were created to display text messages on electronic signs, but the protocols can also display graphics, temperature, counters, and more.

## 3.0 Document information

### 3.1 Revision history

**Table 1: Revision history**

Revision date	Document part number	Notes
May 17, 1995	9708-8061	First release.
August 4, 1995	9708-8061A	<ul style="list-style-type: none"> <li>• PrintPak information added</li> <li>• Printable character terminations added</li> <li>• Identifier page with revision list added</li> </ul>
May 1, 1998	9708-8061B	<ul style="list-style-type: none"> <li>• Document reformatted</li> </ul>
May 28, 1998	9708-8061B	<ul style="list-style-type: none"> <li>• Corrections to 5/1/98 release.</li> </ul>
July 1, 1999	9708-8061C	<ul style="list-style-type: none"> <li>• Various corrections to 5/28/98 release.</li> <li>• "POCSAG" changed to "ASCII Printable"</li> <li>• PrintPak protocol information removed</li> <li>• Y2K date correction information added</li> </ul>
August 15, 2002	9708-8061D	<ul style="list-style-type: none"> <li>• added Alpha 2.0 protocol information</li> <li>• added Betabrite model 1036 character set and symbols</li> <li>• corrected the Extended Character Set in the Alpha protocol ASCII table</li> <li>• corrected the <i>Set Run Time Table</i> Special Function.</li> <li>• added new Special Function for AlphaVision character matrix signs (<i>Display Text at XY Location on Sign</i>)</li> <li>• added Position rules for signs in Appendix.</li> <li>• various minor corrections and additions</li> <li>• added the AlphaEclipse protocol addendum</li> <li>• added font character sets</li> <li>• added Set Automode Table information</li> </ul>
August 1, 2003	9708-8061E	<ul style="list-style-type: none"> <li>• added Alpha 3.0 protocol information (page 132)</li> <li>• expanded Alpha 2.0 protocol information (page 107)</li> <li>• added protocol version comparison table (page 8)</li> <li>• removed "Daylight Savings" command "=" (3DH) because it was never implemented</li> <li>• standardized terminology (for example, "frame" changed to "packet")</li> </ul>
August 25, 2005	9708-8061F	<ul style="list-style-type: none"> <li>• expanded Alpha 3.0 protocol information (page 132)</li> <li>• added network cabling and sign connector pinout information (page 103)</li> <li>• added pass through command examples (page 101)</li> <li>• added AlphaEclipse RoadStar where appropriate</li> <li>• added AlphaEclipse StreetSmart where appropriate</li> <li>• added Euro character to font character sets</li> <li>• various minor corrections and additions</li> </ul>
March 10, 2006	9708-8061F	<ul style="list-style-type: none"> <li>• updated Modular Network Adapter wiring and SHIELD wiring (page 103)</li> </ul>

## 3.2 Document conventions

**Table 2: Document conventions**

Convention	Description
<SOH> or ^A	ASCII control character abbreviation (see page 88)
"A"	ASCII character (in this case the letter A)
11D	Decimal number (in this case, 11). Numbers that are not followed by any letter are also decimal.
0BH	Hexadecimal number (0B hex = 11 decimal)
01001100B	Binary number

## 4.0 Protocol overview

The Alpha line of products — which also includes AlphaVision, AlphaPremiere, and AlphaEclipse signs — supports several types of files and a number of special functions which are used for specific applications:

### 4.1 Displaying text

#### 4.1.1 TEXT files

The ASCII message data and display mode information, along with various other control codes, are stored in TEXT files. DOTS PICTURE files and STRING files may be inserted into a TEXT file.

#### 4.1.2 STRING files

The STRING files are used to store ASCII characters only. STRING files are used in applications where a string of frequently changing data must be transmitted to, and displayed by, a sign. Applications include the storage of a number which changes often, such as a temperature, a quantity, or a timer.

### 4.2 Displaying graphics

#### 4.2.1 SMALL DOTS PICTURE files

SMALL DOTS PICTURE files contain data patterns that correspond to a display picture. These patterns can be used to create virtually any logo pattern on the display of the sign. These SMALL DOTS PICTURE files are accessed via TEXT files. SMALL DOTS PICTURE files have a maximum size of 31 x 255 pixels.

#### 4.2.2 LARGE DOTS PICTURE (also called "ALPHAVISION DOTS PICTURE" or "FAR DOTS PICTURE") files

LARGE DOTS PICTURE files are similar to the SMALL DOTS PICTURE file described above. However, a LARGE DOTS PICTURE file can be much larger. The LARGE DOTS PICTURE file supports data compression during serial transmission and has a maximum size of 65535 x 65535 pixels.

#### 4.2.3 RGB DOTS PICTURE files

Based on LARGE DOTS PICTURE files, a RGB DOTS PICTURE can display over 16 million RGB (Red-Green-Blue) colors.

### 4.3 Special functions

The Alpha network supports a range of SPECIAL FUNCTION commands which give you access to internal registers, diagnostics, and other items.

## 4.4 Protocol version comparison

**Table 3: Protocol version comparison**

		<b>EZKEY II</b>	<b>Alpha 1.0 (EZ95)</b>		<b>Alpha 2.0</b>		<b>Alpha 3.0</b>	
First released:		1991	1995		2001		June 2003	
<b>Data format</b>	Baud rate:	1200, 2400, 4800	1200, 2400, 4800, 9600		1200, 2400, 4800, 9600, 19200, 38400			
	Start bits:	1						
	Data bits:	7	7	8	7	8	7	8
	Parity:	Even	Even	None	Even	None	Even	None
	Stop bits:	2	2	1	2	1	2	1
	Flow control:	None						
	Time-out period:	1 second <sup>1</sup>						
<b>Sign compatibility<sup>7</sup></b>	200 Series <sup>2</sup> :	Yes	Yes	Yes	No	No	No	No
	220C:	Yes	Yes	Yes	No	No	No	No
	300 Series <sup>3</sup> :	Yes	Yes	Yes	No	No	No	No
	420C:	Yes	No	No	No	No	No	No
	430i:	Yes	No	No	No	No	No	No
	440i:	Yes	No	No	No	No	No	No
	460i:	Yes	No	No	No	No	No	No
	790i:	Yes	No	No	No	No	No	No
	4000 Series <sup>4</sup> :	Yes	Yes	Yes	No	No	No	No
	7000 Series <sup>5</sup> :	Yes	Yes	Yes	No	No	No	No
	AlphaEclipse 1500 Time & Temp <sup>6</sup> :	Yes	Yes	Yes	Yes	Yes	No	No
	AlphaEclipse 2500:	Yes	Yes	Yes	Yes	Yes	No	No
	AlphaEclipse 2600:	Yes	Yes	Yes	Yes	Yes	No	No
	AlphaEclipse 3500:	Yes	Yes	Yes	Yes <sup>8</sup>	Yes <sup>8</sup>	No	No
	AlphaEclipse 3600 <sup>9</sup> :	Yes	Yes	Yes	Yes	Yes	Yes	Yes
	AlphaEclipse RoadStar	Yes	Yes	Yes	Yes	Yes	Yes	Yes
	AlphaEclipse StreetSmart	Yes	Yes	Yes	Yes	Yes	Yes	Yes
	AlphaPremiere:	Yes	Yes	Yes	Yes	Yes	No	No
	AlphaVision (full matrix):	Yes	Yes	Yes	No	No	No	No
	AlphaVision (character matrix):	Yes	Yes	Yes	No	No	No	No
	Betabrite:	Yes	Yes	Yes	No	No	No	No
	Big Dot:	Yes	Yes	Yes	No	No	No	No
Director:	Yes	Yes	Yes	No	No	No	No	
PPD (Personal Priority Display):	Yes	Yes	Yes	No	No	No	No	
Serial LED clock <sup>6</sup> :	Yes	Yes	Yes	Yes	Yes	No	No	
Solar:	Yes	Yes	Yes	No	No	No	No	

**NOTES:**

<sup>1</sup> This 1-second delay between each byte applies to the Standard transmission packet (see "Standard transmission packet ("1-byte" or "^A") format" on page 10). However, for ASCII Printable formats (see "ASCII Printable formats" on page 15) the delay can be as long as 30 seconds between each byte.

<sup>2</sup> This includes the 215R and 215C model signs ("C" = tricolor LEDs, "R" = red LEDs).

<sup>3</sup> This includes the 320C and 330C model signs ("C" = tricolor LEDs, "R" = red LEDs).

<sup>4</sup> This includes the 4080C, 4120C, 4120R, 4160C, 4160R, 4200C, 4200R, 4240C, and 4240R model signs ("C" = tricolor LEDs, "R" = red LEDs).

<sup>5</sup> This includes the 7080C, 7120C, 7160C, and 7200C model signs ("C" = tricolor LEDs, "R" = red LEDs).

<sup>6</sup> This sign can only display time updates from messaging software. This sign cannot display text messages or graphics.

<sup>7</sup> "Yes" means the protocol version specified above works with the specified sign.

<sup>8</sup> In order to use the Alpha 2.0 protocol Set Unit commands (see Table 76 on page 107), an AlphaEclipse 3500 Series sign must either be (1) a Series A sign with revision "G" or greater main firmware, or a (2) Series B or greater sign. The Alpha 3.0 Set Unit commands "U7", "U8", and "U9" (see Table 109 on page 132) are only usable with AlphaEclipse 3600 signs.

<sup>9</sup> This sign has RGB (red, green, and blue) LEDs that are capable of displaying over 16 million colors.



## 5.0 Transmission packet formats

Each of the protocols (EZ KEY II, Alpha 1.0, and so on) can be transmitted to a sign in either one of two, basic formats:

1. Standard (Figure 1) — also called the “1-byte” or “^A” format.

<NUL> ^@	<NUL> ^@	<NUL> ^@	<NUL> ^@	<NUL> ^@	<SOH> ^A	Type Code	Sign Address	<STX> ^B	Command Code	Data Field	<EOT> ^D
-------------	-------------	-------------	-------------	-------------	-------------	--------------	-----------------	-------------	-----------------	---------------	-------------

Figure 1: Standard transmission packet

The Standard format has several variations:

- Checksum
- Nesting with Checksums
- Nesting without Checksums

### SPECIAL NOTE

When a sign receives an invalid Checksum, the data in the associated packet will not be processed.

To determine if a packet was received with a valid Checksum, you would have to read the Serial Error Status Register (page 31) immediately after a packet was written to the sign.

2. ASCII Printable — any one of the above Standard formats can be converted into an “ASCII Printable” format by simply making the non-printable control codes *printable* ASCII characters. There are two ways to do this:
  - ASCII Printable “2-byte” format — non-printable characters (like <SOH>) are converted into *two*, printable ASCII characters (like “]!”).
  - ASCII Printable “3-byte” format — non-printable characters (like <SOH>) are converted into *three*, printable ASCII characters (like “\_01”)

### 5.1 Standard transmission packet (“1-byte” or “^A”) format

**SHOW ME**  
An example of the Standard transmission packet is on page 58.

This is called the “1-byte” or “^A” format because single-byte, non-printable control characters like <SOH> are used in the packet:

**Table 4: Standard transmission packet (“1-byte” or “^A”) format**

Item	Name	Description																																																																																																		
<b>A</b>	<NUL>	A minimum of five <NUL>s (00H) must be transmitted as packet synchronization characters. Five <SOH>s (01H) may be substituted for the five <NUL>s. The sign uses these five characters to establish the baud rate.																																																																																																		
<b>B</b>	<SOH>	The <SOH> (01H) is the “Start Of Header” ASCII character.																																																																																																		
<b>C</b>	Type Code	A single ASCII character (to send multiple Type Codes, see item I):																																																																																																		
		<p align="center"><b>Table 5: Type Codes</b></p> <table border="1"> <thead> <tr> <th>Sign Type Code</th> <th>Sign</th> <th>Sign Type Code</th> <th>Sign</th> </tr> </thead> <tbody> <tr> <td>“!” 21H</td> <td>All signs with Visual Verification. This code causes a sign to display the <i>Transmission OK</i> message when a transmission packet is received without an error. Otherwise, <i>Transmission Error</i> will appear.</td> <td>“c” 63H</td> <td>4200C sign</td> </tr> <tr> <td>“”” 22H</td> <td>Serial clock</td> <td>“d” 64H</td> <td>4240C sign</td> </tr> <tr> <td>“#” 23H</td> <td>AlphaVision sign</td> <td>“e” 65H</td> <td>215R sign</td> </tr> <tr> <td>“\$” 24H</td> <td>Full matrix AlphaVision sign</td> <td>“f” 66H</td> <td>215C sign</td> </tr> <tr> <td>“%” 25H</td> <td>Character matrix AlphaVision sign</td> <td>“g” 67H</td> <td>4120R sign</td> </tr> <tr> <td>“&amp;” 26H</td> <td>Line matrix AlphaVision</td> <td>“h” 68H</td> <td>4160R sign</td> </tr> <tr> <td>“0” 30H</td> <td>Response code used only when a sign responds to a request.</td> <td>“i” 69H</td> <td>4200R sign</td> </tr> <tr> <td>“1” 31H</td> <td>One-line signs</td> <td>“j” 6AH</td> <td>4240R sign</td> </tr> <tr> <td>“2” 32H</td> <td>Two-line signs</td> <td>“k” 6BH</td> <td>300 series sign</td> </tr> <tr> <td>“?” 3FH</td> <td>All signs</td> <td>“l” 6CH</td> <td>7000 series sign</td> </tr> <tr> <td>“C” 43H</td> <td>430i sign</td> <td>“m” 6DH</td> <td>96x16 matrix Solar sign</td> </tr> <tr> <td>“D” 44H</td> <td>440i sign</td> <td>“n” 6EH</td> <td>128x16 matrix Solar sign</td> </tr> <tr> <td>“E” 45H</td> <td>460i sign</td> <td>“o” 6FH</td> <td>160x16 matrix Solar sign</td> </tr> <tr> <td>“F” 46H</td> <td>AlphaEclipse 3600 display driver board</td> <td>“p” 70H</td> <td>192x16 matrix Solar sign</td> </tr> <tr> <td>“G” 47H</td> <td>AlphaEclipse 3600 Turbo Adapter board</td> <td>“q” 71H</td> <td>PPD sign</td> </tr> <tr> <td>“L” 4CH</td> <td>Light sensor probe</td> <td>“r” 72H</td> <td>Director sign</td> </tr> <tr> <td>“U” 55H</td> <td>790i sign</td> <td>“s” 73H</td> <td>1005 digit controller</td> </tr> <tr> <td>“V” 56H</td> <td>AlphaEclipse 3600 series</td> <td>“t” 74H</td> <td>4080C sign</td> </tr> <tr> <td>“W” 57H</td> <td>AlphaEclipse Time/Temp</td> <td>“u” 75H</td> <td>210C and 220C signs</td> </tr> <tr> <td>“X” 58H</td> <td>AlphaPremiere 4000 and 9000 series</td> <td>“v” 76H</td> <td>AlphaEclipse 3500 signs</td> </tr> <tr> <td>“Z” 5AH</td> <td>All signs</td> <td>“w” 77H</td> <td>AlphaEclipse 1500 Time &amp; Temp sign</td> </tr> <tr> <td>“^” 5EH</td> <td>Betabrite sign</td> <td>“x” 78H</td> <td>AlphaPremiere 9000 sign</td> </tr> <tr> <td>“a” 61H</td> <td>4120C sign</td> <td>“y” 79H</td> <td>Temperature Probe</td> </tr> <tr> <td>“b” 62H</td> <td>4160C sign</td> <td>“z” 7AH</td> <td>All signs with memory configured for 26 files (“A” - “Z”).</td> </tr> </tbody> </table>	Sign Type Code	Sign	Sign Type Code	Sign	“!” 21H	All signs with Visual Verification. This code causes a sign to display the <i>Transmission OK</i> message when a transmission packet is received without an error. Otherwise, <i>Transmission Error</i> will appear.	“c” 63H	4200C sign	“”” 22H	Serial clock	“d” 64H	4240C sign	“#” 23H	AlphaVision sign	“e” 65H	215R sign	“\$” 24H	Full matrix AlphaVision sign	“f” 66H	215C sign	“%” 25H	Character matrix AlphaVision sign	“g” 67H	4120R sign	“&” 26H	Line matrix AlphaVision	“h” 68H	4160R sign	“0” 30H	Response code used only when a sign responds to a request.	“i” 69H	4200R sign	“1” 31H	One-line signs	“j” 6AH	4240R sign	“2” 32H	Two-line signs	“k” 6BH	300 series sign	“?” 3FH	All signs	“l” 6CH	7000 series sign	“C” 43H	430i sign	“m” 6DH	96x16 matrix Solar sign	“D” 44H	440i sign	“n” 6EH	128x16 matrix Solar sign	“E” 45H	460i sign	“o” 6FH	160x16 matrix Solar sign	“F” 46H	AlphaEclipse 3600 display driver board	“p” 70H	192x16 matrix Solar sign	“G” 47H	AlphaEclipse 3600 Turbo Adapter board	“q” 71H	PPD sign	“L” 4CH	Light sensor probe	“r” 72H	Director sign	“U” 55H	790i sign	“s” 73H	1005 digit controller	“V” 56H	AlphaEclipse 3600 series	“t” 74H	4080C sign	“W” 57H	AlphaEclipse Time/Temp	“u” 75H	210C and 220C signs	“X” 58H	AlphaPremiere 4000 and 9000 series	“v” 76H	AlphaEclipse 3500 signs	“Z” 5AH	All signs	“w” 77H	AlphaEclipse 1500 Time & Temp sign	“^” 5EH	Betabrite sign	“x” 78H	AlphaPremiere 9000 sign	“a” 61H	4120C sign	“y” 79H	Temperature Probe	“b” 62H	4160C sign
Sign Type Code	Sign	Sign Type Code	Sign																																																																																																	
“!” 21H	All signs with Visual Verification. This code causes a sign to display the <i>Transmission OK</i> message when a transmission packet is received without an error. Otherwise, <i>Transmission Error</i> will appear.	“c” 63H	4200C sign																																																																																																	
“”” 22H	Serial clock	“d” 64H	4240C sign																																																																																																	
“#” 23H	AlphaVision sign	“e” 65H	215R sign																																																																																																	
“\$” 24H	Full matrix AlphaVision sign	“f” 66H	215C sign																																																																																																	
“%” 25H	Character matrix AlphaVision sign	“g” 67H	4120R sign																																																																																																	
“&” 26H	Line matrix AlphaVision	“h” 68H	4160R sign																																																																																																	
“0” 30H	Response code used only when a sign responds to a request.	“i” 69H	4200R sign																																																																																																	
“1” 31H	One-line signs	“j” 6AH	4240R sign																																																																																																	
“2” 32H	Two-line signs	“k” 6BH	300 series sign																																																																																																	
“?” 3FH	All signs	“l” 6CH	7000 series sign																																																																																																	
“C” 43H	430i sign	“m” 6DH	96x16 matrix Solar sign																																																																																																	
“D” 44H	440i sign	“n” 6EH	128x16 matrix Solar sign																																																																																																	
“E” 45H	460i sign	“o” 6FH	160x16 matrix Solar sign																																																																																																	
“F” 46H	AlphaEclipse 3600 display driver board	“p” 70H	192x16 matrix Solar sign																																																																																																	
“G” 47H	AlphaEclipse 3600 Turbo Adapter board	“q” 71H	PPD sign																																																																																																	
“L” 4CH	Light sensor probe	“r” 72H	Director sign																																																																																																	
“U” 55H	790i sign	“s” 73H	1005 digit controller																																																																																																	
“V” 56H	AlphaEclipse 3600 series	“t” 74H	4080C sign																																																																																																	
“W” 57H	AlphaEclipse Time/Temp	“u” 75H	210C and 220C signs																																																																																																	
“X” 58H	AlphaPremiere 4000 and 9000 series	“v” 76H	AlphaEclipse 3500 signs																																																																																																	
“Z” 5AH	All signs	“w” 77H	AlphaEclipse 1500 Time & Temp sign																																																																																																	
“^” 5EH	Betabrite sign	“x” 78H	AlphaPremiere 9000 sign																																																																																																	
“a” 61H	4120C sign	“y” 79H	Temperature Probe																																																																																																	
“b” 62H	4160C sign	“z” 7AH	All signs with memory configured for 26 files (“A” - “Z”).																																																																																																	

**Table 4: Standard transmission packet (“1-byte” or “^A”) format**

<b>D</b>	Sign Address	The identifier or “address” of the sign represented by two ASCII digits as a number between “00” and “FF” (0 to 255). Address “00” is reserved as a broadcast address. The wildcard character “?” (3FH) can be used to send messages to a range of addresses. For example, a Sign Address of “0?” will access signs with address between 01H and 0FH (1 and 15). To send multiple Sign Addresses, see item I.																														
<b>E</b>	<STX>	“Start of TeXt” (02H) character. <STX> always precedes a Command Code.  <b>NOTE:</b> When nesting packets, there must be at least a 100-millisecond delay after the <STX>.																														
<b>F</b>	Command Code	<p>One ASCII character that defines the transmission and data types:</p> <p style="text-align: center;"><b>Table 6: Command Codes</b></p> <table border="1" style="margin-left: auto; margin-right: auto;"> <thead> <tr> <th style="text-align: left;">Command Code</th> <th style="text-align: left;">Reference</th> </tr> </thead> <tbody> <tr><td>“A” 41H</td><td>Write TEXT file (see page 18)</td></tr> <tr><td>“B” 42H</td><td>Read TEXT file (see page 19)</td></tr> <tr><td>“E” 45H</td><td>Write SPECIAL FUNCTION commands (see page 21)</td></tr> <tr><td>“F” 46H</td><td>Read SPECIAL FUNCTION commands (see page 29)</td></tr> <tr><td>“G” 47H</td><td>Write STRING file (see page 37)</td></tr> <tr><td>“H” 48H</td><td>Read STRING file (see page 38)</td></tr> <tr><td>“I” 49H</td><td>Write SMALL DOTS PICTURE file (see page 39)</td></tr> <tr><td>“J” 4AH</td><td>Read SMALL DOTS PICTURE file (see page 41)</td></tr> <tr><td>“K” 4BH</td><td>Write RGB DOTS PICTURE file (see page 44) (Alpha 3.0 protocol only)</td></tr> <tr><td>“L” 4CH</td><td>Read RGB DOTS PICTURE file (see page 46) (Alpha 3.0 protocol only)</td></tr> <tr><td>“M” 4DH</td><td>Write LARGE DOTS PICTURE file (see page 42)</td></tr> <tr><td>“N” 4EH</td><td>Read LARGE DOTS PICTURE file (see page 43)</td></tr> <tr><td>“O” 4FH</td><td>Write ALPHAVISION BULLETIN message (see page 48)</td></tr> <tr><td>“T” 54H</td><td>Set Timeout Message (see page 118) (Alpha 2.0 and 3.0 protocols only)</td></tr> </tbody> </table> <p><b>NOTE:</b> When nesting commands, only one “Read” Command Code may be used, and it must be the last Command Code before the &lt;EOT&gt;.</p> <p><b>NOTE:</b> The “Write SPECIAL FUNCTION commands” to Speaker Tone Generation must be the last command in a nested string.</p>	Command Code	Reference	“A” 41H	Write TEXT file (see page 18)	“B” 42H	Read TEXT file (see page 19)	“E” 45H	Write SPECIAL FUNCTION commands (see page 21)	“F” 46H	Read SPECIAL FUNCTION commands (see page 29)	“G” 47H	Write STRING file (see page 37)	“H” 48H	Read STRING file (see page 38)	“I” 49H	Write SMALL DOTS PICTURE file (see page 39)	“J” 4AH	Read SMALL DOTS PICTURE file (see page 41)	“K” 4BH	Write RGB DOTS PICTURE file (see page 44) (Alpha 3.0 protocol only)	“L” 4CH	Read RGB DOTS PICTURE file (see page 46) (Alpha 3.0 protocol only)	“M” 4DH	Write LARGE DOTS PICTURE file (see page 42)	“N” 4EH	Read LARGE DOTS PICTURE file (see page 43)	“O” 4FH	Write ALPHAVISION BULLETIN message (see page 48)	“T” 54H	Set Timeout Message (see page 118) (Alpha 2.0 and 3.0 protocols only)
Command Code	Reference																															
“A” 41H	Write TEXT file (see page 18)																															
“B” 42H	Read TEXT file (see page 19)																															
“E” 45H	Write SPECIAL FUNCTION commands (see page 21)																															
“F” 46H	Read SPECIAL FUNCTION commands (see page 29)																															
“G” 47H	Write STRING file (see page 37)																															
“H” 48H	Read STRING file (see page 38)																															
“I” 49H	Write SMALL DOTS PICTURE file (see page 39)																															
“J” 4AH	Read SMALL DOTS PICTURE file (see page 41)																															
“K” 4BH	Write RGB DOTS PICTURE file (see page 44) (Alpha 3.0 protocol only)																															
“L” 4CH	Read RGB DOTS PICTURE file (see page 46) (Alpha 3.0 protocol only)																															
“M” 4DH	Write LARGE DOTS PICTURE file (see page 42)																															
“N” 4EH	Read LARGE DOTS PICTURE file (see page 43)																															
“O” 4FH	Write ALPHAVISION BULLETIN message (see page 48)																															
“T” 54H	Set Timeout Message (see page 118) (Alpha 2.0 and 3.0 protocols only)																															
<b>G</b>	Data Field	Made up of ASCII characters. The Data Field format is dependent on the preceding Command Code.																														
<b>H</b>	<EOT>	“End Of Transmission” (04H) character																														
<b>I</b>	Multiple Type Codes and Sign Address	<p>Instead of sending a single Type Code and Sign Address (like “g02”), multiple Type Codes and Sign Addresses can be transmitted using the following format:</p> <p>Aaa , Bbb , Ccc , . . . where:</p> <p style="margin-left: 40px;">A, B, and C = ASCII Type Codes  a a , b b , c c = ASCII Sign Addresses separated by commas (2CH), for example, g02 , U01 , 21F , 220</p>																														

### 5.1.1 Checksum format

SHOW ME
An example of the Transmission packet with Checksum is on page 60.

The standard transmission packet format has a few acceptable variations which have their own advantages, depending on the application.

If an <ETX> character is transmitted before the <EOT>, the sign will expect a Checksum.

When a sign receives an invalid Checksum, the associated data will not be processed.

**Table 7: Standard transmission packet with Checksum format**

<b>A</b>	<b>B</b>	<b>C</b>	<b>D</b>	<b>E</b>	<b>F</b>	<b>G</b>	<b>H</b>	<b>I</b>	<b>J</b>			
Item	Name	Description										
<b>A</b>	<NUL>	See Table 4, "Standard transmission packet ("1-byte" or "A") format," on page 10.										
<b>B</b>	<SOH>											
<b>C</b>	Type Code											
<b>D</b>	Sign Address											
<b>E</b>	<STX>											
<b>F</b>	Command Code											
<b>G</b>	Data Field											
<b>H</b>	<ETX>	"End of TeXi" (03H) character										
<b>I</b>	Checksum	Four ASCII digits that represent a 16-bit hexadecimal summation of all transmitted data from the previous <STX> through the previous <ETX> inclusive. The most significant digit is first.  NOTE: When a sign receives an invalid Checksum, the associated data will not be processed. To see if a packet had a valid Checksum, use the Read SPECIAL FUNCTION to check the Serial Error Status Register (see page 29).										
<b>J</b>	<EOT>	See Table 4, "Standard transmission packet ("1-byte" or "A") format," on page 10.										

### 5.1.2 Nesting with Checksums format

**SHOW ME**  
An example of the Nesting with Checksums is on page 61.

If more than one transmission packet is required consecutively, multiple Commands can be repeated or “nested” within a transmission packet.

A sign uses this format when a Memory Dump [see “Read SPECIAL FUNCTION Page Command Code — “F” (46H)” on page 29] is requested serially.

**Table 8: Nesting with Checksums format**

Item	Name	Description					
A	<NUL>	See Table 4, “Standard transmission packet (“1-byte” or “^A”) format,” on page 10.					
B	<SOH>						
C	Type Code						
D	Sign Address						
E	<STX>						
F	Command Code						
G	Data Field						
H	<ETX>	“End of TeXi” (03H) character					
I	Checksum	<p>Four ASCII digits that represent a 16-bit hexadecimal summation of all transmitted data from the previous &lt;STX&gt; through the previous &lt;ETX&gt; inclusive. The most significant digit is first. For example, in the following three nested packets, this is how the checksums are calculated:</p> <div style="text-align: center;"> </div> <p>NOTE: When a sign receives an invalid Checksum, the associated data will not be processed.</p> <p>NOTE: When nesting packets, there must be at least a 100-millisecond delay after the &lt;STX&gt;.</p> <p>NOTE: When nesting commands, only one “Read” Command Code may be used, and it must be the last Command Code before the &lt;EOT&gt;.</p> <p>NOTE: The “Write SPECIAL FUNCTION commands” to Speaker Tone Generation must be the last command in a nested string.</p>					
J	Nested Commands with Checksums	<p>Multiple Commands can be “nested” in a transmission packet. This is the format of the nested packet <i>with a Checksum</i>:</p> <div style="text-align: center;"> <table border="1" style="border-collapse: collapse;"> <tr> <td style="padding: 2px 5px;">&lt;STX&gt; ^B</td> <td style="padding: 2px 5px;">Command Code</td> <td style="padding: 2px 5px;">Data Field</td> <td style="padding: 2px 5px;">&lt;ETX&gt; ^C</td> <td style="padding: 2px 5px;">Checksum</td> </tr> </table> </div>	<STX> ^B	Command Code	Data Field	<ETX> ^C	Checksum
<STX> ^B	Command Code	Data Field	<ETX> ^C	Checksum			
K	<EOT>	See Table 4, “Standard transmission packet (“1-byte” or “^A”) format,” on page 10.					

### 5.1.3 Nesting without Checksums format

If an <STX> is transmitted immediately following an <ETX>, the sign will expect the next “nested” command.

#### SHOW ME

An example of the Nesting without Checksums is on page 62.

**Table 9: Nesting without Checksums transmission packet**

Item	Name	Description								
A	<NUL>	See Table 4, “Standard transmission packet (“1-byte” or “^A”) format,” on page 10.								
B	<SOH>									
C	Type Code									
D	Sign Address									
E	<STX>									
F	Command Code									
G	Data Field									
H	<ETX>		“End of TeXt” (03H) character							
I	Nested Commands without Checksums	<p>Multiple Commands can be “nested” in a transmission packet. This is the format of the nested packet <i>without a Checksum</i>.</p> <table border="1" style="margin-left: auto; margin-right: auto;"> <tr> <td>&lt;STX&gt;</td> <td>Command Code</td> <td>Data Field</td> <td>&lt;ETX&gt;</td> </tr> <tr> <td>^B</td> <td></td> <td></td> <td>^C</td> </tr> </table> <p>NOTE: When nesting packets, there must be at least a 100-millisecond delay after the &lt;STX&gt;.</p> <p>NOTE: When nesting commands, only one “Read” Command Code may be used, and it must be the last Command Code before the &lt;EOT&gt;.</p> <p>NOTE: The “Write SPECIAL FUNCTION commands” to Speaker Tone Generation must be the last command in a nested string.</p>	<STX>	Command Code	Data Field	<ETX>	^B			^C
<STX>	Command Code	Data Field	<ETX>							
^B			^C							
J	<EOT>	See Table 4, “Standard transmission packet (“1-byte” or “^A”) format,” on page 10.								

## 5.2 ASCII Printable formats

### SPECIAL NOTE

For ASCII Printable format baud rate, parity, etc., see Table 3, "Protocol version comparison," on page 8.

Many pagers and computer systems cannot receive or send ASCII control codes (characters lower than 20H). The ASCII Printable format is a variation of the transmission packet that allows the entire protocol to be transmitted *without* sending any ASCII control codes — thus allowing its use with pagers.

This can be implemented in two ways, as shown below. However, an Exception Code must precede all Control Codes that are used in a transmission.

### 5.2.1 ASCII Printable "2-byte" code

This format is often referred to as the "2-byte" protocol because of the use of the "!" characters in the transmission packet.

**Table 10: Standard transmission packet compared with ASCII Printable "2-byte" code transmission packet**

Standard transmission packet (see page 10)	<table border="1"> <tr> <td>&lt;NUL&gt; ^@</td> <td>&lt;NUL&gt; ^@</td> <td>&lt;NUL&gt; ^@</td> <td>&lt;NUL&gt; ^@</td> <td>&lt;NUL&gt; ^@</td> <td>&lt;SOH&gt; ^A</td> <td>Type Code</td> <td>Sign Address</td> <td>&lt;STX&gt; ^B</td> <td>Command Code</td> <td>Data Field</td> <td>&lt;EOT&gt; ^D</td> </tr> </table>	<NUL> ^@	<NUL> ^@	<NUL> ^@	<NUL> ^@	<NUL> ^@	<SOH> ^A	Type Code	Sign Address	<STX> ^B	Command Code	Data Field	<EOT> ^D																								
<NUL> ^@	<NUL> ^@	<NUL> ^@	<NUL> ^@	<NUL> ^@	<SOH> ^A	Type Code	Sign Address	<STX> ^B	Command Code	Data Field	<EOT> ^D																										
ASCII Printable "2-byte" packet	<table border="1"> <tr> <td colspan="2">2-byte code</td> <td></td> <td></td> <td colspan="2">2-byte code</td> <td></td> <td></td> <td></td> <td></td> <td colspan="2">2-byte code</td> </tr> <tr> <td>Exception Code 5DH "!"</td> <td>&lt;SOH&gt; + 20H = 21H "!"</td> <td>Type Code</td> <td>Sign Address</td> <td>Exception Code 5DH "!"</td> <td>&lt;STX&gt; + 20H = 22H ""</td> <td>Command Code</td> <td>Data Field</td> <td>Exception Code 5DH "!"</td> <td>&lt;EOT&gt; + 20H = 24H "\$"</td> <td></td> <td></td> </tr> <tr> <td style="text-align: center;"><b>B</b></td> <td style="text-align: center;"><b>C</b></td> <td style="text-align: center;"><b>D</b></td> <td style="text-align: center;"><b>E</b></td> <td style="text-align: center;"><b>F</b></td> <td style="text-align: center;"><b>G</b></td> <td style="text-align: center;"><b>H</b></td> <td></td> <td></td> <td></td> <td></td> <td></td> </tr> </table>	2-byte code				2-byte code						2-byte code		Exception Code 5DH "!"	<SOH> + 20H = 21H "!"	Type Code	Sign Address	Exception Code 5DH "!"	<STX> + 20H = 22H ""	Command Code	Data Field	Exception Code 5DH "!"	<EOT> + 20H = 24H "\$"			<b>B</b>	<b>C</b>	<b>D</b>	<b>E</b>	<b>F</b>	<b>G</b>	<b>H</b>					
2-byte code				2-byte code						2-byte code																											
Exception Code 5DH "!"	<SOH> + 20H = 21H "!"	Type Code	Sign Address	Exception Code 5DH "!"	<STX> + 20H = 22H ""	Command Code	Data Field	Exception Code 5DH "!"	<EOT> + 20H = 24H "\$"																												
<b>B</b>	<b>C</b>	<b>D</b>	<b>E</b>	<b>F</b>	<b>G</b>	<b>H</b>																															

Item	Name	Description
<b>A</b>	<NUL>	The five <NUL>s (00H) used as packet synchronization are <u>not</u> used in the ASCII Printable transmission format. Since these <NUL>s were used to determine the baud rate, the ASCII Printable baud rate must be preset to 9600.
<b>B</b>	Exception Code	Exception Code = 5DH = "!"
	<SOH> + 20H	<SOH> + 20H = 21H = "!". The <SOH> (01H) ASCII control code is converted to a printable ASCII character by adding the 20H offset.
<b>C</b>	Type Code	See Table 4, "Standard transmission packet ("1-byte" or "A") format," on page 10.
<b>D</b>	Sign Address	
<b>E</b>	Exception Code	Exception Code = 5DH = "!"
	<STX> + 20H	<STX> + 20H = 22H = "". The <STX> (02H) ASCII control code is converted to a printable ASCII character by adding the 20H offset.
<b>F</b>	Command Code	See Table 4, "Standard transmission packet ("1-byte" or "A") format," on page 10.
<b>G</b>	Data Field	
<b>H</b>	Exception Code	Exception Code = 5DH = "!"
	<EOT> + 20H	<EOT> + 20H = 24H = "\$". The <EOT> (04H) ASCII control code is converted to a printable ASCII character by adding the 20H offset.

5.2.2 ASCII Printable “3-byte” code

**Table 11: Standard transmission packet compared with ASCII Printable “3-byte” code transmission packet**

Standard transmission packet (see	<NUL> ^@	<NUL> ^@	<NUL> ^@	<NUL> ^@	<NUL> ^@	<SOH> ^A	Type Code	Sign Address	<STX> ^B	Command Code	Data Field	<EOT> ^D	
ASCII Printable “3-byte” packet	Exception Code 5FH " _"	30H "0"	31H "1"	Type Code	Sign Address	Exception Code 5FH " _"	30H "0"	32H "2"	Command Code	Data Field	Exception Code 5FH " _"	30H "0"	34H "4"

Item	Name	Description
<b>A</b>	<NUL>	The five <NUL>s (00H) used as packet synchronization are <u>not</u> used in the ASCII Printable transmission format. Since these <NUL>s were used to determine the baud rate, the ASCII Printable baud rate must be preset to 9600.
<b>B</b>	Exception Code	Exception Code = 5FH = “_”
	<SOH> =	“0” + “1” The <SOH> (01H) is broken down into two ASCII bytes “0” and “1”.
<b>C</b>	Type Code	See Table 4, “Standard transmission packet (“1-byte” or “^A”) format,” on page 10.
<b>D</b>	Sign Address	
<b>E</b>	Exception Code	Exception Code = 5FH = “_”
	<STX> =	“0” + “2” The <STX> (02H) is broken down into two ASCII bytes “0” and “2”.
<b>F</b>	Command Code	See Table 4, “Standard transmission packet (“1-byte” or “^A”) format,” on page 10.
<b>G</b>	Data Field	
<b>H</b>	Exception Code	Exception Code = 5FH = “_”
	<EOT> =	“0” + “4” The <EOT> (04H) is broken down into two ASCII bytes “0” and “4”.



## 6.0 Command Codes

A Command Code (Table 6, “Command Codes,” on page 11) is used to determine whether information is read from or written to signs.

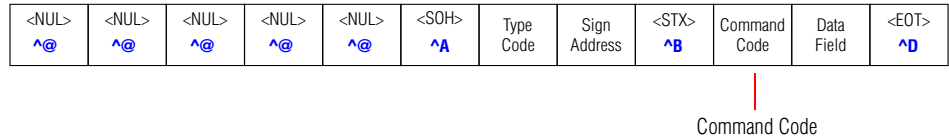

**Figure 2: Command Code location in the Standard transmission packet**

In addition to determining whether information is written or read, Command Codes determine the contents of the Data Field in the protocol transmission packet formats (see “Transmission packet formats” on page 9).

Command Codes fall into six, general categories:

- TEXT file commands
- SPECIAL FUNCTION commands (page 21)
- STRING file commands (page 37)
- SMALL DOTS PICTURE file commands (page 39)
- LARGE DOTS PICTURE file commands (page 42)
- RGB DOTS PICTURE file commands (page 44)
- ALPHAVISION BULLETIN MESSAGE file commands (page 48)

### 6.1 TEXT file commands

The ASCII message data and display mode information, along with various other control codes are stored in TEXT files. On initial power-up, the sign’s memory is configured with one TEXT file (File Label = “A”). If multiple TEXT files are required, refer to the section in SPECIAL FUNCTION commands on Memory Configuration for further details.

When writing to a TEXT file, the display will blank. After the transmission is over, the unit will begin displaying the last received TEXT file.

When reading from a TEXT file, the display will pause when it is sending the transmission packet. Once the unit has completely transmitted the file, it will continue displaying the message from where it was interrupted.

As well as containing the actual message, “calls” to other types of files may be inserted into TEXT files. For example, if you wish to include a DOTS PICTURE as part of a TEXT file, you may simply include a call to a DOTS PICTURE file in the proper location in your TEXT file. Refer to the DOTS PICTURE files section or the STRING files section for further information.

### 6.1.1 Write TEXT file Command Code — “A” (41H)

When writing to a TEXT file, the display will blank. After the transmission is over, the unit will begin displaying the last received TEXT file.

SHOW ME
An example of the Write TEXT Command Code is on page 63.

**Table 12: Write TEXT file transmission packet format**

Standard transmission packet (see page 10)	<table border="1" style="width: 100%; border-collapse: collapse;"> <tr> <td style="width: 10%; text-align: center;">&lt;NUL&gt;</td> <td style="width: 10%; text-align: center;">&lt;NUL&gt;</td> <td style="width: 10%; text-align: center;">&lt;NUL&gt;</td> <td style="width: 10%; text-align: center;">&lt;NUL&gt;</td> <td style="width: 10%; text-align: center;">&lt;NUL&gt;</td> <td style="width: 10%; text-align: center;">&lt;SOH&gt;</td> <td style="width: 10%; text-align: center;">Type Code</td> <td style="width: 10%; text-align: center;">Sign Address</td> <td style="width: 10%; text-align: center;">&lt;STX&gt;</td> <td style="width: 10%; text-align: center;">Command Code</td> <td style="width: 10%; text-align: center;">Data Field</td> <td style="width: 10%; text-align: center;">&lt;EOT&gt;</td> </tr> <tr> <td style="text-align: center;">^@</td> <td style="text-align: center;">^@</td> <td style="text-align: center;">^@</td> <td style="text-align: center;">^@</td> <td style="text-align: center;">^@</td> <td style="text-align: center;">^A</td> <td></td> <td></td> <td style="text-align: center;">^B</td> <td></td> <td></td> <td style="text-align: center;">^D</td> </tr> </table>	<NUL>	<NUL>	<NUL>	<NUL>	<NUL>	<SOH>	Type Code	Sign Address	<STX>	Command Code	Data Field	<EOT>	^@	^@	^@	^@	^@	^A			^B			^D
<NUL>	<NUL>	<NUL>	<NUL>	<NUL>	<SOH>	Type Code	Sign Address	<STX>	Command Code	Data Field	<EOT>														
^@	^@	^@	^@	^@	^A			^B			^D														
	<table border="1" style="width: 100%; border-collapse: collapse;"> <tr> <td style="width: 10%; text-align: center;">41H</td> <td style="width: 10%; text-align: center;">File Label</td> <td style="width: 10%; text-align: center;">&lt;ESC&gt;</td> <td style="width: 10%; text-align: center;">Display Position</td> <td style="width: 10%; text-align: center;">Mode Code</td> <td style="width: 10%; text-align: center;">Special Specifier</td> <td style="width: 10%; text-align: center;">ASCII Message</td> </tr> <tr> <td style="text-align: center;">A</td> <td style="text-align: center;">B</td> <td style="text-align: center;">C</td> <td style="text-align: center;">D</td> <td style="text-align: center;">E</td> <td style="text-align: center;">F</td> <td style="text-align: center;">G</td> </tr> </table>	41H	File Label	<ESC>	Display Position	Mode Code	Special Specifier	ASCII Message	A	B	C	D	E	F	G										
41H	File Label	<ESC>	Display Position	Mode Code	Special Specifier	ASCII Message																			
A	B	C	D	E	F	G																			

Item	Name	Description																		
<b>A</b>	<b>Command Code</b>	“A” (41H) = Write TEXT file																		
<b>B</b>	File Label	One ASCII character that indicates the TEXT file being accessed. See “Appendix A: Valid File Labels” on page 50. If the File Label = “0” (30H), then a Priority TEXT file will be written (see “Priority TEXT files” on page 20).																		
<b>C</b>	<ESC>	<ESC> (1BH) always starts the Mode Field.																		
<b>D</b>	Display Position	<p>A single ASCII character that defines the line position on a multi-line sign:</p> <table style="width: 100%; border-collapse: collapse;"> <tr> <td style="width: 5%; text-align: center;">“ ”</td> <td style="width: 15%;">20H</td> <td>Middle Line — Text centered vertically.</td> </tr> <tr> <td style="text-align: center;">“ ”</td> <td>22H</td> <td>Top Line — Text begins on the top line of the sign and the sign will use all its lines minus 1 in order to display the text. For example, a 6-line sign will allow a maximum of 5 lines (6 minus 1) for the Top Position. The Top/Bottom Line break will remain fixed until the next Middle or Fill position is specified.</td> </tr> <tr> <td style="text-align: center;">“&amp;”</td> <td>26H</td> <td>Bottom Line — The starting position of the Bottom Line(s) immediately follows the last line of the Top Line. For example, a 6-line sign with 3 lines of text associated with the Top Line would start the Bottom Line text on the 4th line of the sign.</td> </tr> <tr> <td style="text-align: center;">“0”</td> <td>30H</td> <td>Fill — The sign will fill all available lines, centering the lines vertically.</td> </tr> <tr> <td style="text-align: center;">“1”</td> <td>31H</td> <td>Left — Text begins on the left side of the sign and the sign will use all its lines minus 1 in order to display the text (Alpha 3.0 protocol only).</td> </tr> <tr> <td style="text-align: center;">“2”</td> <td>32H</td> <td>Right — Text begins on the left side of the sign and the sign will use all its lines minus 1 in order to display the text (Alpha 3.0 protocol only).</td> </tr> </table> <p><b>NOTE:</b> On one-line signs, the Display Position is irrelevant, but it still <u>must</u> be included.</p>	“ ”	20H	Middle Line — Text centered vertically.	“ ”	22H	Top Line — Text begins on the top line of the sign and the sign will use all its lines minus 1 in order to display the text. For example, a 6-line sign will allow a maximum of 5 lines (6 minus 1) for the Top Position. The Top/Bottom Line break will remain fixed until the next Middle or Fill position is specified.	“&”	26H	Bottom Line — The starting position of the Bottom Line(s) immediately follows the last line of the Top Line. For example, a 6-line sign with 3 lines of text associated with the Top Line would start the Bottom Line text on the 4th line of the sign.	“0”	30H	Fill — The sign will fill all available lines, centering the lines vertically.	“1”	31H	Left — Text begins on the left side of the sign and the sign will use all its lines minus 1 in order to display the text (Alpha 3.0 protocol only).	“2”	32H	Right — Text begins on the left side of the sign and the sign will use all its lines minus 1 in order to display the text (Alpha 3.0 protocol only).
“ ”	20H	Middle Line — Text centered vertically.																		
“ ”	22H	Top Line — Text begins on the top line of the sign and the sign will use all its lines minus 1 in order to display the text. For example, a 6-line sign will allow a maximum of 5 lines (6 minus 1) for the Top Position. The Top/Bottom Line break will remain fixed until the next Middle or Fill position is specified.																		
“&”	26H	Bottom Line — The starting position of the Bottom Line(s) immediately follows the last line of the Top Line. For example, a 6-line sign with 3 lines of text associated with the Top Line would start the Bottom Line text on the 4th line of the sign.																		
“0”	30H	Fill — The sign will fill all available lines, centering the lines vertically.																		
“1”	31H	Left — Text begins on the left side of the sign and the sign will use all its lines minus 1 in order to display the text (Alpha 3.0 protocol only).																		
“2”	32H	Right — Text begins on the left side of the sign and the sign will use all its lines minus 1 in order to display the text (Alpha 3.0 protocol only).																		
<b>E</b>	Mode Code	A single ASCII character that represents a “mode” which is a way of displaying an ASCII message. See “Standard Modes” on page 89.																		
<b>F</b>	Special Specifier	(Only required when preceding Mode Code is “n” for SPECIAL.) See “Special Modes” on page 89 and “Special Graphics” on page 90.																		
<b>G</b>	ASCII Message	The actual text to be displayed on a sign. This can also include special Control Characters (see “Appendix G: Alpha protocol ASCII table” on page 81).																		
		<b>NOTE:</b> An ASCII Message <u>cannot</u> be displayed if the previous field (Special Specifier) is a Special Graphic. To display text after a Special Graphic, another Mode Field must be used.																		

**NOTE:** <sup>1</sup>This can be repeated until the sign’s internal memory limit is reached. This limit is dependent on the individual sign.

### 6.1.2 Read TEXT file Command Code — “B” (42H)

**SHOW ME**

An example of the Read TEXT file packet is on page 64.

This command asks a sign to send back a TEXT file.

**NOTE:** Whenever doing a “Read” command on a network with multiple signs, it’s important that each sign has a unique Serial Address. Also, *only one sign at a time should be written to or read from.*

**Table 13: Read TEXT file transmission packet format**

Standard transmission packet (see	<NUL> ^@	<NUL> ^@	<NUL> ^@	<NUL> ^@	<NUL> ^@	<SOH> ^A	Type Code	Sign Address	<STX> ^B	<b>Command Code</b>	<b>Data Field</b>	<EOT> ^D
Item	Name		Description									
<b>A</b>	<b>Command Code</b>		“B” (42H) = Read TEXT file									
<b>B</b>	<b>Data Field</b>	File Label	One ASCII character that indicates the TEXT file being accessed. See “Appendix A: Valid File Labels” on page 50. If the File Label = “0” (30H), then the Priority TEXT file will be read (see “Priority TEXT files” on page 20).									

**SHOW ME**

An example of the Read TEXT file sign response packet is on page 64.

Following the Read TEXT file Command Code, a sign will respond with the following:

**Table 14: Read TEXT file sign response packet format**

	<NUL> ^@	...	<NUL> ^@	<SOH> ^A	Type Code 30H “0”	Sign Address 30H 30H “00”	<STX> ^B	Command Code 41H “A”	File Label	TEXT file data format	<ETX> ^C	Checksum	<EOT> ^D
	A			B	C	D	E	F	G	H	I	J	K
Item	Name		Description										
<b>A</b>	<NUL>		Twenty <NUL>s (00H) characters										
<b>B</b>	<SOH>		<SOH> (01H) character										
<b>C</b>	Type Code		“0” (30H) is the Response code										
<b>D</b>	Sign Address		“00” (30H + 30H) is sent regardless of the sign’s actual address.										
<b>E</b>	<STX>		<STX> (02H) character										
<b>F</b>	Command Code		“A” (41H) is returned by the sign. (This is the Write TEXT Command Code.)										
<b>G</b>	File Label		One ASCII character that indicates the TEXT file being accessed. See “Appendix A: Valid File Labels” on page 50.										
<b>H</b>	TEXT file data format		See Table 12, “Write TEXT file transmission packet format,” on page 18.										
<b>I</b>	<ETX>		<ETX> (03H) character										
<b>J</b>	Checksum		Four ASCII digits that represent a 16-bit hexadecimal summation of all transmitted data from the previous <STX> through the previous <ETX> inclusive. The most significant digit is first.										
<b>K</b>	<EOT>		<EOT> (04H) character										

### 6.1.3 Priority TEXT files

A Priority TEXT file is a special 125-byte message that does not need to be *configured* because it always exists on a sign. When data is written to a Priority TEXT file, all other TEXT files that are currently running will stop being displayed. A Priority TEXT file is created when a File Label = "0" (30H).

**SHOW ME**

Examples of Priority TEXT file packets are on page 68.

The Priority TEXT file will run all by itself until:

- a Write Priority TEXT file without any ASCII Message is sent
- a serial write to the Run Time table takes place
- a serial write to the Run Day table takes place
- an IR keyboard is pointed at the sign and the **PROG** key is pressed

Once a Priority TEXT file stops running, the sign will begin running the other TEXT files.

## 6.2 SPECIAL FUNCTION commands

There are a number of special function commands which give the user additional information and control of the sign.

### 6.2.1 Write SPECIAL FUNCTION Command Code — “E” (45H)

SHOW ME
<p>An example of the Write SPECIAL FUNCTIONS packet is on page 69.                  Examples of Set Memory Configuration start on page 71.</p>

**Table 15: Write SPECIAL FUNCTION Command Code format — “E” (45H)**

Standard transmission packet (see page 10)	<NUL> ^@	<NUL> ^@	<NUL> ^@	<NUL> ^@	<NUL> ^@	<SOH> ^A	Type Code	Sign Address	<STX> ^B	Command Code	Data Field	<EOT> ^D
	Write SPECIAL FUNCTION file transmission packet						45H "E"	Special Functions Label (1 or 2 bytes)	Special Functions Data			
							A	B				
Item	Name	Description										
A	Command Code	"E" (45H) = Write SPECIAL FUNCTION command										
B	<b>Special Functions Label</b>	<b>Special Functions Data</b>										
	" " 20H	<b>Set Time of Day</b> — four ASCII digits used to set the time of day (24-hour format) clock in a sign. The following format is used: HhMm where: H = ASCII digit representing hours (10's digit) h = ASCII digit representing hours (1's digit) M = ASCII digit representing minutes (10's digit) m = ASCII digit representing minutes (1's digit) To display the time, see "Control codes (00 – 1FH)" on page 81.										
	"! " 21H	<b>Enable/Disable a Sign's Speaker</b> — two ASCII characters: "00" 30H + 30H = enable speaker "FF" 46H + 46H = disable speaker ( <b>default</b> )										
	"\$ " 24H	<b>Clear Memory/Set Memory Configuration</b> — To Clear Memory just use "E\$". To Set Memory Configuration 11 (or multiples thereof) ASCII characters are used to set a sign's Memory Configuration table. Memory Configuration is a sign's internal battery-backed up RAM directory. <u>A message file cannot be written until a Memory Configuration is written first</u> — unless the file is a Priority TEXT file or the default TEXT file "A". Also, whenever a Memory Configuration is written, the previous table is overwritten. Memory Configuration uses the following format: FT P S I Z E Q Q Q Q where: <div style="text-align: center;"> <span style="border: 1px solid red; padding: 2px;">FT P S I Z E Q Q Q Q</span> Repeat for <i>each</i> file to be configured.                 </div> F = One ASCII character that represents the File Label. For valid File Labels, see "Appendix A: Valid File Labels" on page 50. T = One ASCII character that represents the file type. Valid file types are: "A" 41H = TEXT file "B" 42H = STRING file "D" 43H = DOTS PICTURE file P = One ASCII character that presents the keyboard protection status, either "U" 55H = Unlocked. Means that the file can be accessed via an IR keyboard. "L" 4CH = Locked. Means that the file can not be accessed via an IR keyboard. (For a STRING file, "L" <i>must</i> be selected.) <sup>1</sup> S I Z E = Four ASCII characters that represent the hexadecimal file size in bytes of a TEXT or STRING file. For a DOTS PICTURE file, the first two bytes = # pixel rows and the last two bytes = # of pixel columns in the picture. Q Q Q Q = Four ASCII hexadecimal characters whose format depends on file type used: <ul style="list-style-type: none"> <li>• For a TEXT file, the first two characters represent the file's Start Time and the last two characters represent the Stop Time. For valid entries, see "Appendix B: Valid Start and Stop times" on page 51.</li> <li>• For a STRING file, use "0000" as place holders because these four characters have no special meaning</li> <li>• For a DOTS PICTURE file, this represents the Color Status. Valid entries are "1000" = monochrome, "2000" = 3-color, "4000" = 8-color (The "E8" command is used for RGB signs. See page 26.)</li> </ul>										

Table 15: Write SPECIAL FUNCTION Command Code format — “E” (45H)

<b>B (cont)</b>	“\$\$\$\$” 24H (four)	<b>Clear Memory and Compact Flash</b> (Alpha 3.0 protocol only) — clears a sign’s memory and its compact flash.
	“&” 26H	<b>Set Day of Week</b> — one ASCII digit that represents the day of the week. A sign will automatically update the day of the week at 12:00 am every day. Valid entries are “1” 31H = Sunday “2” 32H = Monday “3” 33H = Tuesday “4” 34H = Wednesday “5” 35H = Thursday “6” 36H = Friday “7” 37H = Saturday
	“” 27H	<b>Set Time Format</b> — one ASCII character that represents how time is shown on a sign. Valid entries are “S” 53H = Standard am/pm format ( <b>default</b> ) “M” 4DH = 24-hour (military) time
	“(” 28H	<b>Generate Speaker Tone</b> — <sup>2</sup> one to five ASCII characters which generate a tone from a sign’s speaker. Valid entries are <sup>3</sup> “A” 41H = Turn sign speaker on. <sup>3</sup> “B” 42H = Turn sign speaker off. <sup>4</sup> “0” 30H = Generate a continuous tone for about 2 seconds <sup>4</sup> “1” 31H = Generate three, short beeps (total time about 2 seconds) <sup>5</sup> “2” 32H = Generate a programmable tone according to this format: F F D R where F F = Two ASCII hexadecimal characters that represent a speaker frequency. Valid entries are from “00” through “FE”. D = One ASCII hexadecimal character that represents the duration of a tone in 0.1 second increments. Valid entries are from “1” through “F”. R = One ASCII hexadecimal character that represents the number of times a tone is repeated. Valid entries are from “0” through “F”. “3” 33H = (Alpha 2.0 and 3.0 protocols only) See “Store a programmable sound” on page 109. “4” 34H = (Alpha 2.0 and 3.0 protocols only) See “Trigger a programmable sound” on page 109.
	“)” 29H	<b>Set Run Time Table</b> — <sup>6</sup> five ASCII characters used to set the start and stop times in the Run Time table in the following format: F Q Q Q Q where F = One ASCII character that represents a TEXT File Label. Q Q Q Q = Four ASCII hexadecimal characters. The first two characters represent a file’s Start Time and the last two characters represent a file’s Stop Time. For valid entries, see “Appendix B: Valid Start and Stop times” on page 51. These values overwrite the values currently stored in the Memory Configuration table.
	“+” 2BH	<b>Display Text at XY Position</b> — allows up to 250 characters to be displayed at a specified location on an ALPHAVISION character matrix sign using the following format: S F X Y T where:  XYT can repeat which permits <i>many</i> messages to be displayed in <i>many</i> different locations. Use DC2 (12H) as a delimiter after each XYT sequence except for the last sequence. S = Enable/Disable character where: “+” 2BH = Enable XY positioning. While in this mode, all other transmissions are ignored. For example, a write to a text file will be ignored. “-” 2DH = Disable XY positioning F = the File Label. Use “+” 2BH. X = Two ASCII decimal digit characters from “00” to “99” that represent the character position in a sign row to display the text. If X exceeds its limit, it wraps around to the next line or character. Y = Two ASCII decimal digit characters from “00” to “99” that represent the line to display the text. If Y exceeds its limit, it wraps around to the next line or character. T = Up to 250 ASCII characters that represent the message to be displayed. Control codes for color selection, font selection for 5- or 7-high characters, and flash characters are allowed. All other control codes will be ignored. NOTE: To enable XY positioning, first send “E+” or send the first message twice. NOTE: To be able to flash characters, an enable message (STX, “E+”, EOT) must be sent at regular intervals. NOTE: See “Displaying text at XY position examples” on page 77 for examples of XY positioning.
“,” 2CH	<b>Soft Reset</b> — causes a soft reset of the sign. There is no data in this field. A soft reset causes the sign to go through its power-up diagnostics. Memory will <u>not</u> be cleared (non-destructive).	

**Table 15: Write SPECIAL FUNCTION Command Code format — “E” (45H)**

<b>B</b> (cont)	"." 2EH	<p><b>Set Run Sequence</b> — from 3 to 130 ASCII characters that specify the Run Sequence. From 1 to 128 TEXT files can be set using the following format: K P F where:</p> <p style="margin-left: 40px;"> <span style="border-bottom: 1px solid red; display: inline-block; width: 100px;"></span> F repeats for <i>each</i> file to be configured.         </p> <p>K = One ASCII character that represents the type of Run Sequence order:</p> <p>“T” 54H = All subsequent TEXT File Labels in the Run Sequence will run according to their associated <i>times</i> (<b>default</b>).</p> <p>“S” 53H = All subsequent TEXT File Labels in the Run Sequence will run <i>in order</i> regardless of each file’s run time.</p> <p>“D” 44H = All subsequent TEXT file labels in the Run Sequence will run according to their associated times. Then when the file reaches an “off time”, the file will be deleted.</p> <p>P = One ASCII character that represents the keyboard protection status:</p> <p>“U” 55H = Unlocked. This allows the Run Sequence to be changed from a hand-held IR keyboard (<b>default</b>).</p> <p>“L” 4CH = Locked. This makes the Run Sequence inaccessible from a hand-held IR keyboard.</p> <p>F = One ASCII character that represents a valid TEXT File Label (See “Appendix A: Valid File Labels” on page 50). If a File Label is invalid or does not exist, the next File Label will be processed. Up to 128 File Labels can be in a Run Sequence.</p>
	"/" 2FH	<p><b>Set Dimming Register</b> — four ASCII characters that are used to control sign dimming in the following format: WWww where</p> <p>WW = Two ASCII hexadecimal characters that represent <i>when</i> a sign should dim.:</p> <p>“00” = no dimming</p> <p>“01” to “15” is a range where “01” = dark outside and “15” = bright outside</p> <p>ww = Two ASCII hexadecimal characters that represent the <i>level of brightness</i>:</p> <p>“00” = 100% brightness</p> <p>“01” = 86% brightness</p> <p>“02” = 72% brightness</p> <p>“03” = 58% brightness</p> <p>“04” = 44% brightness</p> <p>NOTE: If dimming is not desired, set WWww = “0000” (<b>default</b>).</p> <p>NOTE: Dimming is only available on Solar signs.</p>
		<p><b>Set Dimming Times</b> — four ASCII characters that are used to control sign dimming in the following format: WWww where</p> <p>WW = Two ASCII hexadecimal characters that represent the Start Time of when a sign should dim.</p> <p>ww = Two ASCII hexadecimal characters that represent the Stop Time of when a sign should stop dimming.</p> <p>NOTE: If dimming is not desired, set WWww = “0000” (<b>default</b>).</p> <p>NOTE: Dimming times is only available AlphaEclipse signs.</p>

**Table 15: Write SPECIAL FUNCTION Command Code format — “E” (45H)**

<b>B</b> <b>(cont)</b>	“2”    32H	<p><b>Set Run Day Table</b> — three ASCII characters that are used for <u>each</u> TEXT File Label to set the start and stop days in the Run Day Table in the following format: F S S where</p> <p>F = One ASCII character that represents the TEXT File Label. For valid File Labels, see “Appendix A: Valid File Labels” on page 50.</p> <p>S = One ASCII hexadecimal character that represents run start day for the TEXT file specified by F. Valid start day characters are:</p> <p>“0” 30H = Daily                  “1” 31H = Sunday                  “2” 32H = Monday                  “3” 33H = Tuesday                  “4” 34H = Wednesday                  “5” 35H = Thursday                  “6” 36H = Friday                  “7” 37H = Saturday                  “8” 38H = Monday-Friday                  “9” 39H = Weekends                  “A” 41H = Always                  “B” 42H = Never</p> <p>S = One hexadecimal character that represents the run stop day for the TEXT file specified by F. Valid stop day characters are:</p> <p>“1” 31H = Sunday                  “2” 32H = Monday                  “3” 33H = Tuesday                  “4” 34H = Wednesday                  “5” 35H = Thursday                  “6” 36H = Friday                  “7” 37H = Saturday</p> <p>NOTE: The stop day is required even though the start day may cover multiple days (e.g., Daily, Never, etc.) In this case, the stop day is ignored.</p>															
	“4”    34H	<p><b>Clear Serial Error Status Register</b> — one ASCII character that is used to clear the Serial Error Status Register to its default value of 40H.</p> <p>This register is set to its default value (40H or 01000000B) for the following Command Codes: (1) Read Serial Error Status Register, (2) Network Query, or (3) Clear Serial Error Status Register.</p> <div style="text-align: center;"> <p><b>Serial Error Status Register</b></p> <table border="1" style="margin-left: auto; margin-right: auto;"> <tr> <th>7</th> <th>6</th> <th>5</th> <th>4</th> <th>3</th> <th>2</th> <th>1</th> <th>0</th> </tr> <tr> <td>0</td> <td>1</td> <td>X</td> <td>X</td> <td>X</td> <td>X</td> <td>X</td> <td>X</td> </tr> </table> <p>Default value = 01000000B = 40H</p> <ul style="list-style-type: none"> <li>Always 0</li> <li>Always 1</li> <li>Illegal Command Code, File Label, illegal read or write SPECIAL FUNCTION command</li> <li>Serial Checksum Error</li> <li>Insufficient serial buffer space (overflow)</li> <li>Serial timeout (timeout period exceeded)</li> <li>Bit framing error (incorrect baud rate)</li> <li>Parity error (not even parity)</li> </ul> </div> <p>NOTE: This command should be used as the <i>first command in a nested transmission frame</i> to be sure that all subsequent serial errors or lack of serial errors recorded are applicable to the nested frame. Also, the <i>last command in a nested transmission frame</i> should be a Serial Error Status read (see the “*” command in Table 16, “Read SPECIAL FUNCTION Command Code format — “F” (46H),” on page 29).</p> <p>NOTE: Parity error (not even parity) is not used on most signs.</p>	7	6	5	4	3	2	1	0	0	1	X	X	X	X	X
7	6	5	4	3	2	1	0										
0	1	X	X	X	X	X	X										



**Table 15: Write SPECIAL FUNCTION Command Code format — “E” (45H)**

<p><b>B</b> (cont)</p>	<p>“5”      35H</p>	<p><b>Set Counter</b> — used to set one or more of the five internal timers available on <i>counter-equipped</i> signs. Data for all five counters must be sent as <i>one, large block</i>, in the following format:</p> <p>NOTE: Even if you are only setting one counter, data must be sent to the other counters as well.</p> <p>Standard transmission packet (see page 10)</p> <table border="1" style="margin-left: auto; margin-right: auto;"> <tr> <td>&lt;NUL&gt; ^@</td> <td>&lt;NUL&gt; ^@</td> <td>&lt;NUL&gt; ^@</td> <td>&lt;NUL&gt; ^@</td> <td>&lt;NUL&gt; ^@</td> <td>&lt;SOH&gt; ^A</td> <td>Type Code</td> <td>Sign Address</td> <td>&lt;STX&gt; ^B</td> <td>Command Code</td> <td>Data Field</td> <td>&lt;EOT&gt; ^D</td> </tr> </table> <table border="1" style="margin-left: auto; margin-right: auto;"> <tr> <td>45H 'E'</td> <td>35H '5'</td> <td>31H '1'</td> <td>Counter 1 Data</td> <td>32H '2'</td> <td>Counter 2 Data</td> <td>33H '3'</td> <td>Counter 3 Data</td> <td>34H '4'</td> <td>Counter 4 Data</td> <td>35H '5'</td> <td>Counter 5 Data</td> </tr> </table> <p style="text-align: center;"> <span style="margin-right: 100px;">Command Code for Write SPECIAL FUNCTION</span> <span style="margin-right: 100px;">Special Functions Label for Set/Read Counter</span> <span>Special Functions Data Data for all five counters is sent in one, large block.</span> </p>	<NUL> ^@	<NUL> ^@	<NUL> ^@	<NUL> ^@	<NUL> ^@	<SOH> ^A	Type Code	Sign Address	<STX> ^B	Command Code	Data Field	<EOT> ^D	45H 'E'	35H '5'	31H '1'	Counter 1 Data	32H '2'	Counter 2 Data	33H '3'	Counter 3 Data	34H '4'	Counter 4 Data	35H '5'	Counter 5 Data
		<NUL> ^@	<NUL> ^@	<NUL> ^@	<NUL> ^@	<NUL> ^@	<SOH> ^A	Type Code	Sign Address	<STX> ^B	Command Code	Data Field	<EOT> ^D													
45H 'E'	35H '5'	31H '1'	Counter 1 Data	32H '2'	Counter 2 Data	33H '3'	Counter 3 Data	34H '4'	Counter 4 Data	35H '5'	Counter 5 Data															
<p>The format of <i>Counter 1 Data</i>, <i>Counter 2 Data</i>, etc from above is as follows:  BBTt<sup>8</sup>tSSSSSSSS<sup>10</sup>iiii<sup>10</sup>vvvvvvvv<sup>10</sup>t<sup>9</sup>t<sup>9</sup>tttt<sup>10</sup>FFmm<sup>11</sup>HH<sup>12</sup> where:</p> <p>BB = Two ASCII hexadecimal characters that set the 8 bits of the Counter Control Byte, whose default value is 01100100B (64H). The first ASCII character sets bits 4 - 7 and the second ASCII character sets bits 0 - 3 of the Counter Control Byte. For example, to set the Counter Control Byte to its default value of 64H, an ASCII “6” (36H) and an ASCII “4” (34H) would be sent. Here’s what the 8 bits of the Counter Control Byte mean:</p> <ul style="list-style-type: none"> <li>bit 7 — 1 = counter on, 0 = counter off (<b>default = 0</b>)</li> <li>bit 6 — 1 = increment, 0 = decrement (<b>default = 1</b>)</li> <li>bit 5 — 1 = count minutes, 0 = don’t count minutes (<b>default = 1</b>)</li> <li>bit 4 — 1 = count hours, 0 = don’t count hours (<b>default = 0</b>)</li> <li>bit 3 — 1 = count days, 0 = don’t count days (<b>default = 0</b>)</li> <li>bit 2 — 1 = weekends on, 0 = weekends off (<b>default = 1</b>)</li> <li><sup>7</sup>bit 1 — 1 = Auto Reload ON, Auto Reload OFF (<b>default = 0</b>)</li> <li>bit 0 — 0 (<b>default = 0</b>)</li> </ul> <p><sup>8</sup>T<sup>8</sup>T = Two ASCII hexadecimal characters representing the Counter Start Time. See “Appendix B: Valid Start and Stop times” on page 51. (<b>default = “FF” for Always</b>)</p> <p><sup>9</sup>t<sup>9</sup>t = Two ASCII hexadecimal characters representing the Counter Stop Time. See “Appendix B: Valid Start and Stop times” on page 51. The Counter Stop Time is ignored when the Counter Start Time = “FF” for Always. (<b>default = “00”</b>)</p> <p><sup>10</sup>SSSSSSSS = Eight ASCII characters that represent an 8-digit BCD Counter Start Value. Valid values are from “00000000” to “99999999”. (<b>default = “00000000”</b>)</p> <p><sup>10</sup>iiiiiiii = Eight ASCII characters that represent an 8-digit BCD Counter Change Value. This is the number that is either incremented or decremented according to bit 6 of the Counter Control Byte. Valid values are from “00000000” to “99999999”. (<b>default = “00000001”</b>)</p> <p><sup>10</sup>VVVVVVVV = Eight ASCII characters that represent an 8-digit BCD Current Counter Value. Valid values are from “00000000” to “99999999”. (<b>default = “00000000”</b>)</p> <p><sup>10</sup>tttttttt = Eight ASCII characters that represent an 8-digit BCD Counter Target Value. When this value equals the Current Counter Value, from 0 to 5 Target file messages will be sent according to parameter FF (below). Valid values are from “00000000” to “99999999”. (<b>default = “00000000”</b>)</p> <p>FF = Two ASCII hexadecimal characters that represent the Target File Byte whose default value is 00000000 (00H). The first ASCII character sets bits 4 - 7 and the second ASCII character sets bits 0 - 3 of the Target File Byte. For example, to set a value of 1FH, an ASCII “1” (31H) and an ASCII “F” (46H) would be sent. Here’s what the 8 bits of the Target File Byte mean:</p> <ul style="list-style-type: none"> <li>bit 7 — 0 (<b>default = 0</b>)</li> <li>bit 6 — 0 (<b>default = 0</b>)</li> <li>bit 5 — 0 (<b>default = 0</b>)</li> <li>bit 4 — Target File 1: 1 = enabled, 0 = disabled (<b>default = 0</b>)</li> <li>bit 3 — Target File 2: 1 = enabled, 0 = disabled (<b>default = 0</b>)</li> <li>bit 2 — Target File 3: 1 = enabled, 0 = disabled (<b>default = 0</b>)</li> <li>bit 1 — Target File 4: 1 = enabled, 0 = disabled (<b>default = 0</b>)</li> <li>bit 0 — Target File 5: 1 = enabled, 0 = disabled (<b>default = 0</b>)</li> </ul> <p><sup>11</sup>mm = Two ASCII hexadecimal characters that set the Counter Change Minutes Synchronization. Valid values are from “00” to “3B” (00 - 59). (<b>default = “00”</b>)</p> <p><sup>12</sup>HH = Two ASCII hexadecimal characters that set the Counter Change Hours Synchronization. Valid values are from “00” to “17” (00 - 23) where “00” = 12 am, “01” = 1 am, and so on. (<b>default = “00”</b>)</p>																										

Table 15: Write SPECIAL FUNCTION Command Code format — “E” (45H)

<b>B (cont)</b>	“7” 37H	<p><b>Set Serial Address</b> — Two ASCII hexadecimal characters used to set a sign’s serial address. Valid values are from “00” through “FF”. <b>(default = “00”)</b></p> <p>NOTE: If the serial address has been set using a hardware DIP switch to an address other than “00”, the DIP switch address will override the address set here — once power to the sign has been cycled.</p>
	“8” 38H	<p><sup>13</sup><b>Set LARGE DOTS PICTURE Memory Configuration</b> — a data stream of 24 ASCII characters that repeats for each file configured in a sign. The format for this data stream is as follows: FFFFFFFFFPRRRRCCCCcrrrr where</p> <p>14FFFFFFFF = A 9-character file name</p> <p>P = One ASCII character that represents the keyboard protection status. Valid values are:  “U” 55H = Unlocked. This allows the DOTS PICTURE file to be changed from a hand-held IR keyboard <b>(default)</b>.  “L” 4CH = Locked. This makes the DOTS PICTURE file inaccessible from a hand-held IR keyboard.</p> <p>RRRR = Four ASCII hexadecimal digits that represent the number of pixel rows. Leading zeroes are required (e.g., “0040” = 64 rows).</p> <p>CCCC = Four ASCII hexadecimal digits that represent the number of pixel columns. Leading zeroes are required (e.g., “0060” = 96 columns).</p> <p>CC = Two ASCII hexadecimal digits representing the number of colors in the LARGE DOTS PICTURE. Valid values are:  “01” = monochrome DOTS PICTURE  “02” = tricolor DOTS PICTURE  “08” = RGB DOTS PICTURE (Alpha 3.0 protocol only)</p> <p>rrrr = reserved for future use. Four ASCII zeroes are required — “0000”.</p>
	“9” 39H	<p><b>Append to LARGE DOTS PICTURE file Memory Configuration</b> — allows appending to the LARGE DOTS PICTURE file Memory Configuration. The data format is the same as the LARGE DOTS PICTURE file Memory Configuration data format.</p>
	“.” 3AH	<p><b>Set Run File Times</b> (Alpha 2.0 and 3.0 protocols only) — see “Set Run File Time” on page 110.</p>
	“,” 3BH	<p><b>Set Date</b> — six ASCII characters that are used to set the date in the following format: mmd d y y where</p> <p>mm = Two ASCII digits that represent the month</p> <p>dd = Two ASCII digits that represent the day</p> <p>yy = Two ASCII digits that represent the year</p>
	“<” 3CH	<p><b>Program Custom Character Set</b> (Alpha 2.0 and 3.0 protocols only) — see “Custom character sets” on page 114.</p>
	“>” 3EH	<p><b>Set Automode Table</b> (Alpha 2.0 and 3.0 protocols only) — see “Automode table” on page 117.</p>
	“@” 40H	<p><b>Set Dimming Control Register</b> (Alpha 2.0 and 3.0 protocols only) — see “Dimming Control Register” on page 118.</p>
	“C” 43H	<p><b>Set Color Correction</b> (Alpha 3.0 protocol. AlphaEclipse 3600 sign only.) — sets color correction for an RGB sign where</p> <p>“0” 30H = color correction off.  “1” 31H = RGB color correction <b>(default for RGB color signs)</b>.  “2” 32H = red gamma color correction for mono-color <b>(default for monochrome signs)</b>.</p> <p>EXAMPLE:  &lt;SOH&gt;”Z00”&lt;STX&gt;”EC2”&lt;EOT&gt;  <i>Turn on red gamma color correction.</i></p>
	“C3” 43H 33H	<p><b>Set Color Correction Table</b> (Alpha 3.0 protocol. AlphaEclipse 3600 only) — sets color correction table where</p> <p>“0” 30H = 44 brightness combo.  “1” 31H = 45 brightness combo.  “2” 32H = 54 brightness combo <b>(default for AlphaEclipse 3600)</b>.  “3” 33H = 55 brightness combo.</p> <p>EXAMPLE:  &lt;SOH&gt;”Z00”&lt;STX&gt;”EC33”&lt;EOT&gt;  <i>Set color correction table to LED brightness combo 55.</i></p>
“CX” 43H 58H	<p><b>Set Custom Color Correction Table</b> (Alpha 3.0 protocol. AlphaEclipse 3600 only)—set custom color correction table where</p> <p>Xr — nine character decimal number string (ex. “0.0200000”).  Yr — same as above.  Zr — same as above.  Xg — same as above.  Yg — same as above.  Zg — same as above.  Xb — same as above.  Yb — same as above.  Zb — same as above.</p> <p>EXAMPLE:  &lt;SOH&gt;”Z00”&lt;STX&gt;”ECX0.3572810,0.0872560,0.0313560,0.1485620,  1.3586840,0.0889800,0.0478760,-0.157503,2.3483170”&lt;EOT&gt;  <i>Set custom color correction table.</i></p>	

**Table 15: Write SPECIAL FUNCTION Command Code format — “E” (45H)**

<b>B (cont)</b>	“T” 54H	<p><b>Set Temperature Offset</b> — allows for improvement in temperature accuracy as displayed on message centers which support temperature display (790i, 460i, 440i, and 430i). The data format is as follows: S O where                  S = One ASCII character that stands for the sign of the temperature offset. Valid values are:                  “+” 2BH = a positive offset                  “-” 2DH = a negative offset                  O = One ASCII hexadecimal character that stands for the temperature offset. Valid values are from “0” through “9”.                  For a Solar sign, an actual temperature is sent, not an offset. The Solar sign itself computes the offset. The data format for a Solar sign is as follows: S O where:                  S = One ASCII character that stands for the sign of the temperature. Valid values are:                  “+” 2BH = a positive temperature                  “-” 2DH = a negative temperature                  O = Three ASCII hexadecimal characters that stand for an actual temperature.</p>
	“U1” 55H 31H	<b>Set Unit Columns and Rows</b> (Alpha 2.0 and 3.0 protocols only) — see “Set Unit commands” on page 128.
	“U2” 55H 32H	<b>Set Unit Run Mode</b> (Alpha 2.0 and 3.0 protocols only) — see “Set Unit commands” on page 128.
	“U3” 55H 33H	<b>Set Unit Serial Address</b> (Alpha 2.0 and 3.0 protocols only) — see “Set Unit commands” on page 128.
	“U4” 55H 34H	<b>Set Unit Serial Data</b> (Alpha 2.0 and 3.0 protocols only) — see “Set Unit commands” on page 128.
	“U5” 55H 35H	<b>Set Unit Configuration</b> (Alpha 2.0 and 3.0 protocols only) — see “Set Unit commands” on page 128.
	“U7” 55H 37H	<p><b>Set Unit Internal Network</b> (Alpha 3.0 protocol only. AlphaEclipse 3600 sign only.) — allows access to the sign’s internal network in the following format: HD where                  H = sign header packet                  D = data packet for sign’s internal network</p> <p>This is the header packet format for the turbo adapter or RGB driver board:                  Type code — one ASCII byte “G” (turbo adapter) or “F” (RGB driver board)                  Serial address — two ASCII bytes that represent the hexadecimal address                  Turbo channel — two ASCII bytes that represent the turbo adapter channel number in hexadecimal                  See “Appendix K: Pass Through Command Examples” on page 101 for more information.</p> <p>NOTE: There is a 1-second wait for the peripheral device to respond back.</p>
	“U8” 55H 38H	<p><b>Set Unit Slave Device</b> (Alpha 3.0 protocol only. AlphaEclipse 3600 sign only.) — displays the message specified in the File Label of this command on the slave sign.</p> <p>EXAMPLE:                  &lt;SOH&gt;”Z00”&lt;STX&gt;”E08A”&lt;EOT&gt;                  Displays the message in File Label= “A” on the slave sign.</p>
	“U9” 55H 39H	<b>Set Unit Internal Network</b> (Alpha 3.0 protocol only. AlphaEclipse 3600 sign only.) — Same as “U7” except there is no 1-second delay waiting for the peripheral device to respond. See “Appendix K: Pass Through Command Examples” on page 101 for more information..
	“UN” 55H 4EH	<b>Write Unit Register</b> (Alpha 2.0 and 3.0 protocols only) — see “Set Unit commands” on page 128.
“s” 73H	<b>Enable/Disable ACK/NAK Response</b> (Alpha 2.0 and 3.0 protocols only) — see “Enable/Disable ACK/NAK response” on page 121.	
<p>NOTE: <sup>1</sup> The sum of <u>all</u> the file sizes (except for SMALL DOTS PICTURE and LARGE DOTS PICTURE files) plus 11 bytes of overhead for <u>each</u> file should not exceed the total amount of available memory in the pool. A value of “0000” is a valid SIZE for the <u>last</u> file in the Memory Configuration only if this last file is a TEXT file. This assigns all remaining memory to the file.</p> <p><sup>2</sup> When sending nested frames, the tone generation command must be the last transmission frame because the sign’s serial port is disabled (and cannot receive any data) while a tone is generated. A tone generation command can never be part of any type of READ command, except on the AlphaPremiere sign, which can tone and receive at the same time.</p> <p><sup>3</sup> This command should <u>not</u> be used with the standard speaker/piezo alarm provided in the sign as it may damage the sign.</p> <p><sup>4</sup> Wait a minimum of 3 seconds before transmitting more data to the sign, except on the AlphaPremiere sign, which can tone and receive at the same time.</p> <p><sup>5</sup> Wait until the programmable tone has finished before transmitting more data to the sign, except on the AlphaPremiere sign, which can tone and receive at the same time.</p> <p><sup>6</sup> This 5-byte field repeats for each TEXT file configured in the sign. Not all TEXT files need to be updated, only those that require modification.</p> <p><sup>7</sup> When the Counter Target Value has been reached, Auto Reload ON will put into the Counter Start Value in Current Counter Value.</p>		

**Table 15: Write SPECIAL FUNCTION Command Code format — “E” (45H)**

NOTE: <sup>8</sup> Time codes “FD” and “FE” are not valid as Counter Start Times.

<sup>9</sup> Time codes “FD”, “FE”, and “FF” are not valid as Counter Stop Times.

<sup>10</sup> Leading 0’s must be sent if the value is less than 8 digits long. For example, “256” would be sent as “00000256”.

<sup>11</sup> This value is used when the Counter Control Byte is set to count hours or days. If minutes are being counted, this value is ignored. However, a value must still be supplied.

<sup>12</sup> This value is used when the Counter Control Byte is set to count days. If minutes or hours are being counted, this value is ignored. However, a value must still be supplied.

<sup>13</sup> See LARGE DOTS PICTURE Memory Configuration *only* applies to Full Matrix ALPHAVISION, Series 7000, AlphaEclipse, and AlphaPremiere signs.

<sup>14</sup> If a file name is less than 9 characters, it must be padded with leading spaces (20H) so that the total number of characters is always nine.

<sup>15</sup> For Alpha protocol version 2.0 and greater, the year (yy) is windowed as follows: “00 to “96” = 2000 to 2096. “97” to “99” = 1997 to 1999.

**6.2.2 Read SPECIAL FUNCTION Command Code — “F” (46H)**

**SHOW ME**  
An example of the Read SPECIAL FUNCTION command is on page 69.

**NOTE:** Whenever doing a “Read” command on a network with multiple signs, it’s important that each sign has a *unique* Serial Address. Also, only one sign at a time should be accessed or read from.

**Table 16: Read SPECIAL FUNCTION Command Code format — “F” (46H)**

Standard transmission packet (see page 10)	<NUL> ^@	<NUL> ^@	<NUL> ^@	<NUL> ^@	<NUL> ^@	<SOH> ^A	Type Code	Sign Address	<STX> ^B	Command Code	Data Field	<EOT> ^D
Read SPECIAL FUNCTION file transmission packet	46H "F"	Special Functions Label (1 or 2 bytes)	Special Functions Data	The Special Functions Data field is included in this packet for explanation only. This data is returned in the Read SPECIAL FUNCTION command response packet. See Table 18, "Read SPECIAL FUNCTION file sign response packet format," on page 36.								
<b>A</b>	Command Code	"F" (46H) = Read SPECIAL FUNCTION file										
<b>B</b>	Special Functions Label	<b>Special Functions Data</b> (This data is returned in a Read SPECIAL FUNCTION file sign response. See Table 18, "Read SPECIAL FUNCTION file sign response packet format," on page 36)										
	" " 20H	<b>Read Time of Day</b> — returns four ASCII digits that represent the time of day (24-hour format) clock in a sign. The following format is used: HhMm where: H = ASCII digit representing hours (10's digit) h = ASCII digit representing hours (1's digit) M = ASCII digit representing minutes (10's digit) m = ASCII digit representing minutes (1's digit) To display the time on a sign, see the "Control characters" in "Appendix G: Alpha protocol ASCII table" on page 81.										
	"!" 21H	<b>Read Speaker Status</b> — returns two ASCII characters: "00" 30H + 30H = speaker enabled "FF" 46H + 46H = speaker disabled ( <b>default</b> )										
" "" 22H	<b>Read General Information</b> — returns 28 or 29 ASCII characters in the following format: <NUL>FFFFFFFFfMmYyHhNnRSSPOOL, pool where ^NUL = 00H FFFFFFFF = Eight ASCII characters that stand for the firmware installed in the sign f = One ASCII character that stands for the firmware revision letter MmYy = Four ASCII digits that stand for the release date of the firmware. For example, firmware released in January 1993 would be represented as "0193". HhNn = Four ASCII digits that represent the time of day (24-hour format) clock in a sign. The format is the same used for <b>Read Time of Day</b> above. R = One ASCII character that represents how time is displayed on a sign where: "S" 53H = standard am/pm format ( <b>default</b> ) "M" 4DH = 24-hour (or military) time SS = Speaker status where: "00" 30H + 30H = speaker enabled "FF" 46H + 46H = speaker disabled ( <b>default</b> ) POOL, pool = Memory Pool where: POOL = Four-digit ASCII hexadecimal number that represents the <i>total size</i> of the Memory Pool in bytes. The most significant digit is first. , = 2CH (a comma) pool = Four-digit ASCII hexadecimal number that represents the <i>unused</i> portion of the Memory Pool in bytes. The most significant digit is first. NOTE: General Information is most useful as a source of troubleshooting information.											

**Table 16: Read SPECIAL FUNCTION Command Code format — “F” (46H)**

<b>B (cont)</b>	“#” 23H	<p><b>Read Memory Pool Size</b> — returns nine ASCII characters that indicate the total size and available amount of the Memory Pool. The Memory Pool is a sign’s internal battery-backed up RAM that is available for file storage. Any unused memory is assigned to the first TEXT file listed in the Memory Configuration once the sign starts running.</p> <p>The Memory Pool is in the following format: POOL, P O O L. The format is the same used in <b>Read General Information</b> above.</p>
	“\$” 24H	<p><b>Read Memory Configuration</b> — returns eleven ASCII characters that represent a sign’s Memory Configuration table. Memory Configuration is a sign’s internal battery-backed up RAM directory. Memory Configuration uses the following format: FTFSIZEEQQQQ where:</p> <p>F = One ASCII character that represents the File Label. For valid File Labels, see “Appendix A: Valid File Labels” on page 50.</p> <p>T = One ASCII character that represents the file type. Valid file types are:  “A” 41H = TEXT file  “B” 42H = STRING file  “D” 43H = DOTS PICTURE file</p> <p>P = One ASCII character that presents the keyboard protection status, either  “U” 55H = Unlocked. Means that the file can be accessed via an IR keyboard.  “L” 4CH = Locked. Means that the file can not be accessed via an IR keyboard.</p> <p><sup>2</sup>S I Z E = Four ASCII characters that represent the hexadecimal file size in bytes of a TEXT or STRING file.</p> <p>Q Q Q Q = Four ASCII hexadecimal characters whose format depends on file type used:</p> <ul style="list-style-type: none"> <li>• For a TEXT file, the first two characters represent the file’s Start Time and the last two characters represent the Stop Time. For valid entries, see “Appendix B: Valid Start and Stop times” on page 51.</li> <li>• For a STRING file, “0000” is used as place holders because these four characters have no special meaning.</li> <li>• For a DOTS PICTURE file, this represents the Color Status. Valid entries are  “1000” = monochrome DOTS PICTURE  “2000” = 3-color DOTS PICTURE  “4000” = 8-color DOTS PICTURE  RGB signs use “F8” (see page 34)</li> </ul>
	“%” 25H	<p><b>Memory Dump</b> — returns multiple nested transmission frames with checksums (see “Nesting with Checksums format” on page 13) in the following order:</p> <ol style="list-style-type: none"> <li>1. Time-of-day setting (see <b>Read Time of Day</b> above)</li> <li>2. Memory Configuration (see <b>Read Memory Configuration</b> above)</li> <li>3. Transmission frame of each file (Write TEXT, STRING, or DOTS PICTURE file) in the order it appears in Memory Configuration</li> <li>4. Run Sequence (see <b>Read Run Sequence</b> below)</li> <li>5. Run Day Table (see <b>Read Run Day Table</b> below)</li> <li>6. Day-of-Week setting (see <b>Read Day-of-Week</b> below)</li> <li>7. Counter Functions (see <b>Read Counter Functions</b> below)</li> </ol>
	“&” 26H	<p><b>Read Day of Week</b> — returns one ASCII digit that represents the day of the week. A sign will automatically update the day of the week at 12:00 am every day. Valid entries are  “1” 31H = Sunday  “2” 32H = Monday  “3” 33H = Tuesday  “4” 34H = Wednesday  “5” 35H = Thursday  “6” 36H = Friday  “7” 37H = Saturday</p>
	“” 27H	<p><b>Read Time Format</b> — returns one ASCII character that represents how time is shown on a sign. Valid entries are  “S” 53H = Standard am/pm format (<b>default</b>)  “M” 4DH = 24-hour (military) time</p>
	“)” 29H	<p><b>Read Run Time Table</b> — returns the following ASCII characters: L q q q q F Q Q Q Q E where:</p> <p>L = “0” 30H which represents the PRIORITY TEXT File Label.</p> <p>q q q q = Four ASCII hexadecimal characters which show the PRIORITY TEXT file status. There are only two possibilities for this:  “FE00” = PRIORITY TEXT file is not running  “FF00” = PRIORITY TEXT file is running.</p> <p><sup>3</sup>F = One ASCII character that represents a TEXT File Label (see “Appendix A: Valid File Labels” on page 50)</p> <p>Q Q Q Q = Four ASCII hexadecimal characters. The first two characters represent a file’s Start Time and the last two characters represent a file’s Stop Time. For valid entries, see “Appendix B: Valid Start and Stop times” on page 51. These values overwrite the values currently stored in the Memory Configuration table.</p> <p>E = One ASCII hexadecimal character which represents the file enable status. Valid codes are:  “0” 30H = file is <u>not</u> currently being displayed  “1” 31H = file is currently being displayed</p>

**Table 16: Read SPECIAL FUNCTION Command Code format — “F” (46H)**

<p><b>B</b> <b>(cont)</b></p>	<p>2AH</p>	<p><b>Read Serial Error Status Register</b> — returns one bitmapped ASCII character read from a sign's Serial Error Status Register that represents serial errors recorded by a sign.</p> <p>This register is set to its default value (40H or 01000000B) for the following Command Codes: (1) Read Serial Error Status Register, (2) Network Query, or (3) Clear Serial Error Status Register.</p> <p>The sign begins error checking following a valid &lt;SOH&gt; (01H).</p> <p>The Serial Error Status Register is bitmapped as follows:</p> <div style="text-align: center;"> <p><b>Serial Error Status Register</b></p> <table border="1" style="margin: auto;"> <tr> <th>7</th> <th>6</th> <th>5</th> <th>4</th> <th>3</th> <th>2</th> <th>1</th> <th>0</th> </tr> <tr> <td>0</td> <td>1</td> <td>x</td> <td>x</td> <td>x</td> <td>x</td> <td>x</td> <td>x</td> </tr> </table> <p>Default value = 01000000B = 40H</p> <ul style="list-style-type: none"> <li>Always 0</li> <li>Always 1</li> <li>Illegal Command Code, File Label, illegal read or write SPECIAL FUNCTION command</li> <li>Serial Checksum Error</li> <li>Insufficient serial buffer space (overflow)</li> <li>Serial timeout (timeout period exceeded)</li> <li>Bit framing error (incorrect baud rate)</li> <li>Parity error (not even parity)</li> </ul> </div> <p><b>NOTE:</b> Errors are OR'd into the Serial Error Status Register. That is, more than one error at a time can be recorded in the register.</p> <p><b>NOTE:</b> Parity error (not even parity) is not used on most signs.</p>	7	6	5	4	3	2	1	0	0	1	x	x	x	x	x	x
7	6	5	4	3	2	1	0											
0	1	x	x	x	x	x	x											

**Table 16: Read SPECIAL FUNCTION Command Code format — “F” (46H)**

<b>B (cont)</b>	“-” 2DH	<p><b>Network Query</b> — returns the unit type, Serial Address, and Serial Error Status Register for each sign on the network. The response from each sign is in the following format: UAAZ where:</p> <p>U = One ASCII character that stands for the unit type of a sign. For valid entries, see “Type Code” in “Standard transmission packet (“1-byte” or “^A”) format” on page 10.</p> <p>AA = Two ASCII hexadecimal characters that represent a sign’s serial address</p> <p>Z = One ASCII character that represents the Serial Error Status Register of a sign (see above)</p> <p><b>NOTE:</b> Normally, a Network Query is broadcast to all signs using a “00” in the Sign Address field. When a Network Query is broadcast like this, all signs on the network respond in the following manner: Once the &lt;EOT&gt; is received by a sign, it will respond to the Network Query after a timed interval. This interval is a sum of 1 second plus the product of a sign’s address and 0.5 seconds. For example, a sign with an address of 0FH (15), would reply after 1 + (15 x 0.5) = 8.5 seconds.</p> <p><b>NOTE:</b> If there are two or more signs on a network with the <i>same</i> Serial Address, then a Network Query will produce unpredictable results. A response from one of these signs may be garbled because there is no collision detection.</p>
	“.” 2EH	<p><b>Read Run Sequence</b> — returns from 3 to 130 ASCII characters that specify the Run Sequence. From 1 to 128 TEXT files will be read in the following format: K P F where:</p> <p style="text-align: center;">  </p> <p>K = One ASCII character that represents the type of Run Sequence order:</p> <p>“T” 54H = All subsequent TEXT File Labels in the Run Sequence will run according to their associated <i>times</i> (<b>default</b>).</p> <p>“S” 53H = All subsequent TEXT File Labels in the Run Sequence will run <i>in order</i> regardless of each file’s run time.</p> <p>P = One ASCII character that represents the keyboard protection status:</p> <p>“U” 55H = Unlocked. This allows the Run Sequence to be changed from a hand-held IR keyboard (<b>default</b>).</p> <p>“L” 4CH = Locked. This makes the Run Sequence inaccessible from a hand-held IR keyboard.</p> <p>F = One ASCII character that represents a valid TEXT File Label (See “Appendix A: Valid File Labels” on page 50). If a File Label is invalid or does not exist, the next File Label will be processed. Up to 128 File Labels can be in a Run Sequence.</p>
	“2” 32H	<p><b>Read Run Day Table</b> — returns three ASCII characters that are used for <u>each</u> TEXT File Label to read the start and stop days in the Run Day Table in the following format: F S S where</p> <p>F = One ASCII character that represents the TEXT File Label. For valid File Labels, see “Appendix A: Valid File Labels” on page 50.</p> <p>S = One ASCII hexadecimal character that represents run start day for the TEXT file specified by F. Valid start day characters are:</p> <p>“0” 30H = Daily</p> <p>“1” 31H = Sunday</p> <p>“2” 32H = Monday</p> <p>“3” 33H = Tuesday</p> <p>“4” 34H = Wednesday</p> <p>“5” 35H = Thursday</p> <p>“6” 36H = Friday</p> <p>“7” 37H = Saturday</p> <p>“8” 38H = Monday-Friday</p> <p>“9” 39H = Weekends</p> <p>“A” 41H = Always</p> <p>“B” 42H = Never</p> <p>S = One hexadecimal character that represents the run stop day for the TEXT file specified by F. Valid stop day characters are:</p> <p>“1” 31H = Sunday</p> <p>“2” 32H = Monday</p> <p>“3” 33H = Tuesday</p> <p>“4” 34H = Wednesday</p> <p>“5” 35H = Thursday</p> <p>“6” 36H = Friday</p> <p>“7” 37H = Saturday</p>



**Table 16: Read SPECIAL FUNCTION Command Code format — “F” (46H)**

<p><b>B</b> (cont)</p>	<p>“5”      35H</p>	<p><b>Read Counter</b> — returns data for all five counters is received as <i>one, large block</i>, in the following format:</p> <div style="text-align: center;"> </div>
		<p>The format of <i>Counter 1 Data</i>, <i>Counter 2 Data</i>, and so on from above is as follows:                  BBTTttSSSSSSSSiiiiiVVVVVVVtttttttFFmmHH where:</p> <p>BB = Two ASCII hexadecimal characters that stand for the 8 bits of the Counter Control Byte, whose default value is 01100100B (64H). The first ASCII character sets bits 4 - 7 and the second ASCII character sets bits 0 - 3 of the Counter Control Byte. Here's what the 8 bits of the Counter Control Byte mean:</p> <ul style="list-style-type: none"> <li>bit 7 — 1 = counter on, 0 = counter off (<b>default = 0</b>)</li> <li>bit 6 — 1 = increment, 0 = decrement (<b>default = 1</b>)</li> <li>bit 5 — 1 = count minutes, 0 = don't count minutes (<b>default = 1</b>)</li> <li>bit 4 — 1 = count hours, 0 = don't count hours (<b>default = 0</b>)</li> <li>bit 3 — 1 = count days, 0 = don't count days (<b>default = 0</b>)</li> <li>bit 2 — 1 = weekends on, 0 = weekends off (<b>default = 1</b>)</li> <li>bit 1 — 1 = Auto Reload ON, Auto Reload OFF (<b>default = 0</b>)</li> <li>bit 0 — 0 (<b>default = 0</b>)</li> </ul> <p><sup>5</sup>TT = Two ASCII hexadecimal characters representing the Counter Start Time. See "Appendix B: Valid Start and Stop times" on page 51. (<b>default = "FF" for Always</b>)</p> <p><sup>6</sup>tt = Two ASCII hexadecimal characters representing the Counter Stop Time. See "Appendix B: Valid Start and Stop times" on page 51. The Counter Stop Time is ignored when the Counter Start Time = "FF" for Always. (<b>default = "00"</b>)</p> <p><sup>7</sup>SSSSSSSS = Eight ASCII characters that represent an 8-digit BCD Counter Start Value. Valid values are from "00000000" to "99999999". (<b>default = "00000000"</b>)</p> <p><sup>7</sup>iiiiiii = Eight ASCII characters that represent an 8-digit BCD Counter Change Value. This is the number that is either incremented or decremented according to bit 6 of the Counter Control Byte. Valid values are from "00000000" to "99999999". (<b>default = "00000001"</b>)</p> <p><sup>7</sup>VVVVVVVV = Eight ASCII characters that represent an 8-digit BCD Current Counter Value. Valid values are from "00000000" to "99999999". (<b>default = "00000000"</b>)</p> <p><sup>7</sup>tttttttt = Eight ASCII characters that represent an 8-digit BCD Counter Target Value. When this value equals the Current Counter Value, from 0 to 5 Target file messages will be sent according to parameter FF (below). Valid values are from "00000000" to "99999999". (<b>default = "00000000"</b>)</p> <p>FF = Two ASCII hexadecimal characters that represent the Target File Byte whose default value is 00000000 (00H). The first ASCII character sets bits 4 - 7 and the second ASCII character sets bits 0 - 3 of the Target File Byte. For example, to set a value of 1FH, an ASCII "1" (31H) and an ASCII "F" (46H) would be sent. Here's what the 8 bits of the Target File Byte mean:</p> <ul style="list-style-type: none"> <li>bit 7 — 0 (<b>default = 0</b>)</li> <li>bit 6 — 0 (<b>default = 0</b>)</li> <li>bit 5 — 0 (<b>default = 0</b>)</li> <li>bit 4 — Target File 1: 1 = enabled, 0 = disabled (<b>default = 0</b>)</li> <li>bit 3 — Target File 2: 1 = enabled, 0 = disabled (<b>default = 0</b>)</li> <li>bit 2 — Target File 3: 1 = enabled, 0 = disabled (<b>default = 0</b>)</li> <li>bit 1 — Target File 4: 1 = enabled, 0 = disabled (<b>default = 0</b>)</li> <li>bit 0 — Target File 5: 1 = enabled, 0 = disabled (<b>default = 0</b>)</li> </ul> <p><sup>8</sup>mm = Two ASCII hexadecimal characters that set the Counter Change Minutes Synchronization. Valid values are from "00" to "3B" (00 - 59). (<b>default = "00"</b>)</p> <p><sup>9</sup>HH = Two ASCII hexadecimal characters that set the Counter Change Hours Synchronization. Valid values are from "00" to "17" (00 - 23) where "00" = 12 am, "01" = 1 am, and so on. (<b>default = "00"</b>)</p>

**Table 16: Read SPECIAL FUNCTION Command Code format — “F” (46H)**

<b>B (cont)</b>	“8” 38H	<p><sup>10</sup><b>Read LARGE DOTS PICTURE Memory Configuration</b> — returns a data stream of 24 ASCII characters that repeats for each file configured in a sign. The format for this data stream is as follows: FFFFFFFFPRRRRCCCCcrrrr where:</p> <p style="padding-left: 40px;">11 FFFFFFFF = A 9-character file name</p> <p>P = One ASCII character that represents the keyboard protection status. Applies to the AlphaVision, AlphaEclipse, AlphaPremiere, and series 7000 signs. Valid values are:</p> <p style="padding-left: 40px;">“U” 55H = Unlocked. This allows the DOTS PICTURE file to be changed from a hand-held IR keyboard (<b>default</b>).</p> <p style="padding-left: 40px;">“L” 4CH = Locked. This makes the DOTS PICTURE file inaccessible from a hand-held IR keyboard.</p> <p>RRRR = Four ASCII hexadecimal digits that represent the number of pixel rows. Leading zeroes are required (e.g., “0040” = 64 rows).</p> <p>CCCC = Four ASCII hexadecimal digits that represent the number of pixel columns. Leading zeroes are required (e.g., “0060” = 96 columns).</p> <p>CC = Two ASCII hexadecimal digits representing the number of colors in the LARGE DOTS PICTURE. Valid values are:</p> <p style="padding-left: 40px;">“01” = a monochrome DOTS PICTURE</p> <p style="padding-left: 40px;">“02” = a tricolor DOTS PICTURE</p> <p style="padding-left: 40px;">“04” = 8-color DOTS PICTURE</p> <p style="padding-left: 40px;">“08” = RGB DOTS PICTURE</p> <p>rrrr = reserved for future use. Four ASCII zeroes are required — “0000”.</p>
	“:” 3AH	<b>Read Run File Times</b> (Alpha 2.0 and 3.0 protocols only) — see “Reading Run File Time” on page 111.
	“,” 3BH	<b>Read Date</b> — returns six ASCII characters that are used to set the date in the following format: mmddyy where
	“>” 3EH	<b>Read Automode Table</b> (Alpha 2.0 and 3.0 protocols only) — see “Automode table” on page 117.
	“C” 43H	<p><b>Read Color Correction</b> (Alpha 3.0 protocol. AlphaEclipse 3600 sign only.) — returns a single ASCII digit where</p> <p style="padding-left: 40px;">“0” 30H = color correction off.</p> <p style="padding-left: 40px;">“1” 31H = RGB color correction (<b>default</b>).</p> <p style="padding-left: 40px;">“2” 32H = red gamma color correction for mono-color (red or amber) signs.</p> <p>EXAMPLE:</p> <p style="padding-left: 40px;">&lt;SOH&gt;”Z00”&lt;STX&gt;”FC”&lt;EOT&gt;</p> <p style="padding-left: 80px;"><i>Reads current color correction.</i></p>
	“L” 4CH	<b>Read Temperature Log</b> (Alpha 2.0 and 3.0 protocols only) — see “Temperature Logging” on page 122.
	“T” 54H	<p><b>Read Temperature Offset</b> — returns two ASCII characters in the following format: S0 where:</p> <p>S = One ASCII character that stands for the sign of the temperature offset. Valid values are:</p> <p style="padding-left: 40px;">“+” 2BH = a positive offset</p> <p style="padding-left: 40px;">“-” 2DH = a negative offset</p> <p>O = One ASCII hexadecimal character that stands for the temperature offset. Valid values are from “0” through “9”.</p> <p><i>For a Solar sign, an actual temperature is read, not an offset. The Solar sign itself computes the offset. The data format for a Solar sign is as follows: S0 where:</i></p> <p>S = One ASCII character that stands for the sign of the temperature. Valid values are:</p> <p style="padding-left: 40px;">“+” 2BH = a positive temperature</p> <p style="padding-left: 40px;">“-” 2DH = a negative temperature</p> <p>O = Three ASCII hexadecimal characters that stand for an actual temperature.</p>
	“U1” 55H 31H	<b>Read Unit Columns and Rows</b> (Alpha 2.0 and 3.0 protocols only) — see “Set Unit commands” on page 128.
	“U2” 55H 32H	<b>Read Unit Run Mode</b> (Alpha 2.0 and 3.0 protocols only) — see “Set Unit commands” on page 128.
	“U3” 55H 33H	<b>Read Unit Serial Address</b> (Alpha 2.0 and 3.0 protocols only) — see “Set Unit commands” on page 128.
“U4” 55H 34H	<b>Read Unit Serial Data</b> (Alpha 2.0 and 3.0 protocols only) — see “Set Unit commands” on page 128.	
“U5” 55H 35H	<b>Read Unit Configuration</b> (Alpha 2.0 and 3.0 protocols only) — see “Set Unit commands” on page 128.	
“U6” 55H 36H	<b>Read Unit Register</b> (Alpha 2.0 and 3.0 protocols only) — see “Set Unit commands” on page 128.	

**Table 16: Read SPECIAL FUNCTION Command Code format — “F” (46H)**

<b>B</b> (cont)	“v”      76H	<p><b>Read Firmware Revisions Command</b> (Alpha 3.0 protocol only)— reads comma-delimited firmware and FPGA part numbers in the following format: ABCDEFGHIJ. For Example: the command [SOH]Z01[STX]Fv[EOT] returns data in the following format.</p> <p style="text-align: center;">[SOH]000[STX]Ev<b>11805001A,11805007a,26211801a,26211802a,11805007a,26211801a,26211802a,11805008a, 0102D02,0202A02</b>[EXT]1146[EOT]</p> <p>where:</p> <p style="text-align: center;"><b>Table 17: Breakdown of Firmware Revisions Output</b></p> <table border="1" style="width: 100%; border-collapse: collapse;"> <thead> <tr> <th></th> <th style="text-align: center;">Data (12 bytes)</th> <th style="text-align: center;">Description</th> <th style="text-align: center;">Sample Output (above)</th> </tr> </thead> <tbody> <tr> <td style="text-align: center;"><b>A</b></td> <td>Firmware Part Number</td> <td>The firmware part number</td> <td>11805001A~~~</td> </tr> <tr> <td style="text-align: center;"><b>B</b></td> <td>FPGA part number</td> <td>The main FPGA part number</td> <td>11805007a~~~</td> </tr> <tr> <td style="text-align: center;"><b>C</b></td> <td>FPGA controller part number</td> <td>The controller FPGA part number</td> <td>26211801a~~~</td> </tr> <tr> <td style="text-align: center;"><b>D</b></td> <td>FPGA turbo part number</td> <td>The turbo FPGA part number</td> <td>26211802a~~~</td> </tr> <tr> <td style="text-align: center;"><b>E</b></td> <td>Backup FPGA part number</td> <td>The backup main FPGA part number</td> <td>11805007a~~~</td> </tr> <tr> <td style="text-align: center;"><b>F</b></td> <td>Backup FPGA controller part number</td> <td>The backup FPGA controller part number</td> <td>26211801a~~~</td> </tr> <tr> <td style="text-align: center;"><b>G</b></td> <td>Backup FPGA turbo part number</td> <td>The backup FPGA turbo part number</td> <td>26211802a~~~</td> </tr> <tr> <td style="text-align: center;"><b>H</b></td> <td>Boot Code version</td> <td>The Boot Code part number</td> <td>11805008A~~~</td> </tr> <tr> <td style="text-align: center;"><b>I</b></td> <td>Controller FPGA version</td> <td>AA — major revision (00 - FF) BB — minor revision (00 - FF) C — series letter (A - Z) DD — build revision (00 - FF)</td> <td>AA — “01” BB — “02” C — “D” DD — “02”</td> </tr> <tr> <td style="text-align: center;"><b>J</b></td> <td>Turbo FPGA version</td> <td>AA — major revision (00 - FF) BB — minor revision (00 - FF) C — series revision (A - Z) DD — build revision (00 - FF)</td> <td>AA — “02” BB — “02” C — “A” DD — “02”</td> </tr> </tbody> </table> <p>~ = 20H Space</p> <p>NOTE: This command only applies to AlphaPremiere and AlphaEclipse signs.</p>		Data (12 bytes)	Description	Sample Output (above)	<b>A</b>	Firmware Part Number	The firmware part number	11805001A~~~	<b>B</b>	FPGA part number	The main FPGA part number	11805007a~~~	<b>C</b>	FPGA controller part number	The controller FPGA part number	26211801a~~~	<b>D</b>	FPGA turbo part number	The turbo FPGA part number	26211802a~~~	<b>E</b>	Backup FPGA part number	The backup main FPGA part number	11805007a~~~	<b>F</b>	Backup FPGA controller part number	The backup FPGA controller part number	26211801a~~~	<b>G</b>	Backup FPGA turbo part number	The backup FPGA turbo part number	26211802a~~~	<b>H</b>	Boot Code version	The Boot Code part number	11805008A~~~	<b>I</b>	Controller FPGA version	AA — major revision (00 - FF) BB — minor revision (00 - FF) C — series letter (A - Z) DD — build revision (00 - FF)	AA — “01” BB — “02” C — “D” DD — “02”	<b>J</b>	Turbo FPGA version	AA — major revision (00 - FF) BB — minor revision (00 - FF) C — series revision (A - Z) DD — build revision (00 - FF)	AA — “02” BB — “02” C — “A” DD — “02”
			Data (12 bytes)	Description	Sample Output (above)																																									
		<b>A</b>	Firmware Part Number	The firmware part number	11805001A~~~																																									
		<b>B</b>	FPGA part number	The main FPGA part number	11805007a~~~																																									
		<b>C</b>	FPGA controller part number	The controller FPGA part number	26211801a~~~																																									
		<b>D</b>	FPGA turbo part number	The turbo FPGA part number	26211802a~~~																																									
		<b>E</b>	Backup FPGA part number	The backup main FPGA part number	11805007a~~~																																									
		<b>F</b>	Backup FPGA controller part number	The backup FPGA controller part number	26211801a~~~																																									
		<b>G</b>	Backup FPGA turbo part number	The backup FPGA turbo part number	26211802a~~~																																									
		<b>H</b>	Boot Code version	The Boot Code part number	11805008A~~~																																									
<b>I</b>	Controller FPGA version	AA — major revision (00 - FF) BB — minor revision (00 - FF) C — series letter (A - Z) DD — build revision (00 - FF)	AA — “01” BB — “02” C — “D” DD — “02”																																											
<b>J</b>	Turbo FPGA version	AA — major revision (00 - FF) BB — minor revision (00 - FF) C — series revision (A - Z) DD — build revision (00 - FF)	AA — “02” BB — “02” C — “A” DD — “02”																																											

NOTE: <sup>1</sup> This byte is transmitted only on some signs.

<sup>2</sup> The sum of all the file sizes (except for SMALL DOTS PICTURE and LARGE DOTS PICTURE files) plus 11 bytes of overhead for each file should not exceed the total amount of available memory in the pool. A value of “0000” is a valid SIZE for the last file in the Memory Configuration only if this last file is a TEXT file. This assigns all remaining memory to the file.

<sup>3</sup> The last 6 bytes (FQQQQE) repeat for each TEXT file configured in the sign (with the exception of the PRIORITY TEXT file which preceded this field.

<sup>4</sup> When the Counter Target Value has been reached, Auto Reload ON will put into the Counter Start Value in Current Counter Value.

<sup>5</sup> Time codes “FD” and “FE” are not valid as Counter Start Times.

<sup>6</sup> Time codes “FD”, “FE”, and “FF” are not valid as Counter Stop Times.

<sup>7</sup> Leading 0’s must be sent if the value is less than 8 digits long. For example, “256” would be sent as “00000256”.

<sup>8</sup> This value is used when the Counter Control Byte is set to count hours or days. If minutes are being counted, this value is ignored. However, a value must still be supplied.

<sup>9</sup> This value is used when the Counter Control Byte is set to count days. If minutes or hours are being counted, this value is ignored. However, a value must still be supplied.

<sup>10</sup> Read LARGE DOTS PICTURE Memory Configuration *only* applies to Full Matrix AlphaVision, AlphaEclipse, AlphaPremiere, and Series 7000 signs.

<sup>11</sup> If a file name is less than 9 characters, it must be padded with leading spaces (20H) so that the total number of characters is always nine.

**SHOW ME**  
 An example of the Read SPECIAL FUNCTION file response packet is on page 70.

Following the Read SPECIAL FUNCTION file Command Code, a sign will respond with the following:

**Table 18: Read SPECIAL FUNCTION file sign response packet format**

<NUL> ^@	. . .	<NUL> ^@	<SOH> ^A	Type Code 30H "0"	Sign Address 30H 30H "00"	<STX> ^B	Command Code 45H "E"	Special Functions Label	Special Functions Data	<ETX> ^C	Checksum	<EOT> ^D
A		B	C	D	E	F	G	H	I	J	K	

Item	Name	Description
A	<NUL>	Twenty <NUL> (00H) characters
B	<SOH>	<SOH> (01H) character
C	Type Code	"0" (30H) is the Response code
D	Sign Address	"00" (30H + 30H) is sent regardless of the sign's actual address.
E	<STX>	<STX> (02H) character
F	Command Code	"E" (45H) is returned by the sign. (The Write SPECIAL FUNCTIONs Command Code.)
G	Special Functions Label	One ASCII character that indicates the SPECIAL FUNCTION being accessed. See Table 15, "Write SPECIAL FUNCTION Command Code format — "E" (45H)," on page 21 and Table 16, "Read SPECIAL FUNCTION Command Code format — "F" (46H)," on page 29.
H	Special Functions Data	See Table 15, "Write SPECIAL FUNCTION Command Code format — "E" (45H)," on page 21. and Table 16, "Read SPECIAL FUNCTION Command Code format — "F" (46H)," on page 29.
I	<ETX>	<ETX> (03H) character
J	Checksum	Four ASCII digits that represent a 16-bit hexadecimal summation of all transmitted data from the previous <STX> through the previous <ETX> inclusive. The most significant digit is first.
K	<EOT>	<EOT> (04H) character

### 6.3 STRING file commands

**SPECIAL NOTE**

For more information on using STRING files, see “Appendix D: STRING file notes” on page 53.

STRING files are used to store short ASCII sets of characters which may be “called up” from a TEXT file. The main purpose of a STRING file is to display frequently changing information. When writing STRING files to a message center, the display will not blank as it does when writing TEXT files. This is because the STRING file data is buffered and TEXT file internal Checksum does not change. *Because the STRING file data is buffered, the size of a STRING file is limited to 125 bytes.*

Before writing to a STRING file, memory must be allocated for the STRING file in the sign. (For further information, see “Set Memory Configuration” in Table 15, “Write SPECIAL FUNCTION Command Code format — “E” (45H),” on page 21.)

STRING files are called from a TEXT file using the TEXT file Control character designated for a “Call STRING file”. (For further information, see “Control characters” in “Appendix G: Alpha protocol ASCII table” on page 81).

When reading from a STRING file, once the transmission packet has been sent, a sign will either pause or blank, depending on the sign type. Once a sign has transmitted the file, the sign will continue displaying the message from where it was interrupted.

#### 6.3.1 Write STRING file Command Code — “G” (47H)

**SHOW ME**

An example of the Write STRING file packet is on page 74.

**Table 19: Write STRING file transmission packet format**

Standard transmission packet (see page 10)	<NUL> ^@	<NUL> ^@	<NUL> ^@	<NUL> ^@	<NUL> ^@	<SOH> ^A	Type Code	Sign Address	<STX> ^B	<b>Command Code</b>	<b>Data Field</b>	<EOT> ^D
										48H "G"	File Label	STRING File Data
										<b>A</b>	<b>B</b>	<b>C</b>
Item	Name	Description										
<b>A</b>	Command Code	"G" (47H) = Write STRING file										
<b>B</b>	File Label	One ASCII character that indicates the STRING file being accessed. See “Appendix A: Valid File Labels” on page 50.										
<b>C</b>	STRING File Data	This data can be ASCII characters 20H through 7FH and the following Control characters (for more information, see “Appendix G: Alpha protocol ASCII table” on page 81) : 09H = No Hold speed 0DH = New line 11H = Disable wide characters <b>(default)</b> 12H = Enable wide characters 13H = Call Time (time of day will be called up) 15H = Speed 1 (slowest) 16H = Speed 2 17H = Speed 3 18H = Speed 4 <b>(default)</b> 19H = Speed 5 (fastest) 1AH = Select character set 1CH = Select character color (Rainbow 1 and 2 colors do not work in STRING files) 1EH = Select character spacing										

### 6.3.2 Read STRING file Command Code — “H” (48H)

**SHOW ME**

An example of the Read STRING file packet is on page 75.

**NOTE:** Whenever doing a “Read” command on a network with multiple signs, it’s important that each sign has a unique Serial Address. Also, only one sign at a time should be read from.

**Table 20: Read STRING file transmission packet format**

Standard transmission packet (see page 10)	<NUL> ^@	<NUL> ^@	<NUL> ^@	<NUL> ^@	<NUL> ^@	<SOH> ^A	Type Code	Sign Address	<STX> ^B	<b>Command Code</b>	<b>Data Field</b>	<EOT> ^D
										48H "H"	File Label	
										A	B	

Item	Name	Description
A	Command Code	"H" (48H) = Read STRING file
B	Data Field File Label	One ASCII character that indicates the STRING file being accessed. See "Appendix A: Valid File Labels" on page 50.

**SHOW ME**

An example of the Read STRING file sign response packet is on page 75.

Following the Read STRING file Command Code, a sign will respond with the following:

**Table 21: Read STRING file sign response packet format**

	<NUL> ^@	...	<NUL> ^@	<SOH> ^A	Type Code 30H "0"	Sign Address 30H 30H "00"	<STX> ^B	Command Code 47H "G"	File Label	STRING File Data	<ETX> ^C	Checksum	<EOT> ^D
	A		B	C	D	E	F	G	H	I	J	K	

Item	Name	Description
A	<NUL>	Twenty <NUL>s (00H) characters
B	<SOH>	<SOH> (01H) character
C	Type Code	"0" (30H) is the Response code
D	Sign Address	"00" (30H + 30H) is sent regardless of the sign's actual address.
E	<STX>	<STX> (02H) character
F	Command Code	"G" (47H) is returned by the sign. (The Write STRING file Command Code.)
G	File Label	One ASCII character that indicates the STRING file being accessed. See "Appendix A: Valid File Labels" on page 50.
H	STRING File Data	See Table 19, "Write STRING file transmission packet format," on page 37.
I	<ETX>	<ETX> (03H) character
J	Checksum	Four ASCII digits that represent a 16-bit hexadecimal summation of all transmitted data from the previous <STX> through the previous <ETX> inclusive. The most significant digit is first.
K	<EOT>	<EOT> (04H) character

## 6.4 SMALL DOTS PICTURE file commands

### SPECIAL NOTE

The size of a SMALL DOTS PICTURE file can be up to 31 x 255 pixels.

If a graphic needs to be larger than this, then use a LARGE DOTS PICTURE file (see "LARGE DOTS PICTURE file commands" on page 42).

SMALL DOTS PICTURE files are used to store dot patterns which are displayed by "calling" a picture file from a TEXT file. See "Call SMALL DOTS PICTURE" file in "Control codes (00 – 1FH)" on page 81.

The purpose of SMALL DOTS PICTURE files is to display small (up to 31 x 255 pixels) graphics, such as logos.

When a SMALL DOTS PICTURE file is written to a sign, the sign will go blank until the transmission is complete.

When reading from a SMALL DOTS PICTURE file, once the transmission packet has been sent, the sign will pause. Once a sign has completely transmitted the file, the sign will continue displaying the message from where it was interrupted.

### 6.4.1 Write SMALL DOTS PICTURE file Command Code — "I" (49H)

#### SHOW ME

An example of the Write SMALL DOTS PICTURE file packet is on page 76.

Table 22: Write SMALL DOTS PICTURE file transmission packet format

Standard transmission packet (see page 10)	<NUL> ^@	<NUL> ^@	<NUL> ^@	<NUL> ^@	<NUL> ^@	<SOH> ^A	Type Code	Sign Address	<STX> ^B	<b>Command Code</b>	<b>Data Field</b>	<EOT> ^D
--	-------------	-------------	-------------	-------------	-------------	-------------	-----------	--------------	-------------	---------------------	-------------------	-------------

Width (x) = up to 255 LED pixels

How SMALL DOTS PICTURES are drawn on a LED sign

49H "I"	File Label	DOTS PICTURE File Data
------------	------------	------------------------

A

B

Height (y)	Width (x)	Row Bit Pattern	<CR> ^M	<LF> (optional) ^J
------------	-----------	-----------------	------------	-----------------------

These fields repeat y times.

C

Item	Name		Description
A	Command Code		"I" (49H) = Write SMALL DOTS PICTURE file
B	File Label		One ASCII character that indicates the DOTS PICTURE file accessed. See "Appendix A: Valid File Labels" on page 50.
C	Data Field	DOTS PICTURE File Data	Height (y)
			Two ASCII hexadecimal bytes that represent the number of pixel rows in a SMALL DOTS PICTURE (a value from 0 to 31). This must match the pixel row bytes set up in "Set LARGE DOTS PICTURE Memory Configuration" in Table 15, "Write SPECIAL FUNCTION Command Code format — "E" (45H)," on page 21.
			<b>NOTE:</b> In a LARGE DOTS PICTURE, four ASCII hexadecimal bytes are used to represent the number of pixel rows (a value from 0 to 65535).

**Table 22: Write SMALL DOTS PICTURE file transmission packet format**

<b>C</b> (cont)	Data Field (cont)	DOTS PICTURE File Data (cont)	Width (x)	<p>Two ASCII hexadecimal bytes that represent the number of pixel columns in a SMALL DOTS PICTURE (a value from 0 to 255). This must match the pixel column bytes set up in "Set LARGE DOTS PICTURE Memory Configuration" in Table 15, "Write SPECIAL FUNCTION Command Code format — "E" (45H)," on page 21.</p> <p><b>NOTE:</b> In a LARGE DOTS PICTURE, four ASCII hexadecimal bytes are used to represent the number of pixel columns (a value from 0 to 65535).</p> <p><b>NOTE:</b> When sending a Write SMALL DOTS PICTURE file, the sign receiving the file will clear the current SMALL DOTS PICTURE file in memory immediately following the Width information.</p> <p><b>NOTE:</b> Following the Width bytes, there should be at least a 100 millisecond delay (not to exceed the timeout period) before sending the Row Bit Pattern.</p>																	
			<sup>1</sup> Row Bit Pattern	<p>The Width (x) number of ASCII characters which represent all the pixels in a row. The first ASCII character = the leftmost pixel in the row, the 2nd ASCII character = the next pixel in the row, etc. (see example below). Valid values are:</p> <table style="width: 100%; border: none;"> <tr> <td>"0" 30H = pixel off</td> <td>"4" 34H = pixel on - dim red</td> </tr> <tr> <td>"1" 31H = pixel on - red</td> <td>"5" 35H = pixel on - dim green</td> </tr> <tr> <td>"2" 32H = pixel on - green</td> <td>"6" 36H = pixel on - brown</td> </tr> <tr> <td>"3" 33H = pixel on - amber</td> <td>"7" 37H = pixel on - orange</td> </tr> <tr> <td></td> <td>"8" 38H = pixel on - yellow</td> </tr> </table> <p><b>NOTE:</b> Some signs do not support the full range of colors.</p> <p>To draw a green SMALL DOTS PICTURE like this (on the 7 x 35 pixel sign shown below) . . .</p> <div style="border: 2px solid black; padding: 5px; text-align: center;"> </div> <p>. . . the DOTS PICTURE File Data would look like this:</p> <table border="1" style="margin-left: auto; margin-right: auto;"> <tr> <td style="text-align: center;">Height (y)</td> <td style="text-align: center;">Width (x)</td> <td style="text-align: center;">Row Bit Pattern</td> <td style="text-align: center;">&lt;CR&gt;</td> <td style="text-align: center;">&lt;LF&gt; (optional)</td> </tr> <tr> <td style="text-align: center;">"07"</td> <td style="text-align: center;">"23" (Hexadecimal for 35)</td> <td style="text-align: center;">^M</td> <td style="text-align: center;">^J</td> <td></td> </tr> </table> <p style="margin-left: 20px;">"0" = LED pixel off "2" = LED pixel on - green</p> <pre style="margin-left: 20px;"> "00000000000000000000002000000000000000" &lt;CR&gt;&lt;LF&gt; "00000000000000000000202000000000000000" &lt;CR&gt;&lt;LF&gt; "00000000000000000000200020000000000000" &lt;CR&gt;&lt;LF&gt; "0000000000000000000020000000200000000000" &lt;CR&gt;&lt;LF&gt; "00000000000000200000000002000000000000" &lt;CR&gt;&lt;LF&gt; "000000000000200000000000200000000000" &lt;CR&gt;&lt;LF&gt; "00000000000222222222222222220000000000" &lt;CR&gt;&lt;LF&gt; </pre> <p style="margin-left: 20px;">Row delimiter character &lt;CR&gt; (0DH). The last &lt;CR&gt; is optional.</p> <p style="margin-left: 20px;">If &lt;LF&gt;s are sent, they will <u>not</u> be sent back in a Read SMALL DOTS PICTURE response. (See "Read SMALL DOTS PICTURE file Command Code — "J" (4AH)" on page 41.)</p> <p><b>NOTE:</b> If the number of row pixel characters is <i>greater than</i> the Width (x), then the extra row pixel characters will be ignored. If the number of row pixel characters is <i>less than</i> the Width (x), then the remaining row pixel characters will be turned off ("0").</p>	"0" 30H = pixel off	"4" 34H = pixel on - dim red	"1" 31H = pixel on - red	"5" 35H = pixel on - dim green	"2" 32H = pixel on - green	"6" 36H = pixel on - brown	"3" 33H = pixel on - amber	"7" 37H = pixel on - orange		"8" 38H = pixel on - yellow	Height (y)	Width (x)	Row Bit Pattern	<CR>	<LF> (optional)	"07"	"23" (Hexadecimal for 35)
"0" 30H = pixel off	"4" 34H = pixel on - dim red																				
"1" 31H = pixel on - red	"5" 35H = pixel on - dim green																				
"2" 32H = pixel on - green	"6" 36H = pixel on - brown																				
"3" 33H = pixel on - amber	"7" 37H = pixel on - orange																				
	"8" 38H = pixel on - yellow																				
Height (y)	Width (x)	Row Bit Pattern	<CR>	<LF> (optional)																	
"07"	"23" (Hexadecimal for 35)	^M	^J																		

**NOTE:** <sup>1</sup> DATA COMPRESSION — Row Bit Pattern can be data compressed as follows for LARGE DOTS PICTURE files. Data compression can be done anywhere within the Row Bit Pattern. The format for data compression is: <CTR - Q>XXB where:

- <CTR - Q> = 11H
- XX = Two ASCII hexadecimal characters from "00" to "FF" that stand for the number of times + 1 to repeat B (the pixel color). For example, a value of "0A" (10) means repeat 10 + 1 = 11 times.
- B = Pixel color. Valid values are shown in Row Bit Pattern field above.



**6.4.2 Read SMALL DOTS PICTURE file Command Code — “J” (4AH)**

NOTE: Whenever doing a “read” command on a network with multiple signs, it’s important that each sign has a unique Serial Address. Also, only one sign at a time should be read from.

**Table 23: Read SMALL DOTS PICTURE file transmission packet format**

Standard transmission packet (see page 10)	<NUL> ^@	<NUL> ^@	<NUL> ^@	<NUL> ^@	<NUL> ^@	<SOH> ^A	Type Code	Sign Address	<STX> ^B	<b>Command Code</b>	<b>Data Field</b>	<EOT> ^D
										4AH "J"	File Label	
										A	B	

Item	Name	Description
A	Command Code	"J" (4AH) = Read SMALL DOTS PICTURE file
B	Data Field File Label	One ASCII character that indicates the SMALL DOTS PICTURE file being accessed. See "Appendix A: Valid File Labels" on page 50.

Following the Read SMALL DOTS PICTURE file Command Code, a sign will respond with the following:

**Table 24: Read SMALL DOTS PICTURE file sign response packet format**

<NUL> ^@	...	<NUL> ^@	<SOH> ^A	Type Code 30H "0"	Sign Address 30H 30H "00"	<STX> ^B	Command Code 49H "I"	File Label	DOTS PICTURE File Data	<ETX> ^C	Checksum	<EOT> ^D
A			B	C	D	E	F	G	H	I	J	K

Item	Name	Description
A	<NUL>	Twenty <NUL>s (00H) characters
B	<SOH>	<SOH> (01H) character
C	Type Code	"0" (30H) is the Response code
D	Sign Address	"00" (30H + 30H) is sent regardless of the sign's actual address.
E	<STX>	<STX> (02H) character
F	Command Code	"I" (49H) is returned by the sign. (The Write SMALL DOTS PICTURE file Command Code.)
G	File Label	One ASCII character that indicates the SMALL DOTS PICTURE file being accessed. See "Appendix A: Valid File Labels" on page 50.
H	DOTS PICTURE File Data	See Table 22, "Write SMALL DOTS PICTURE file transmission packet format," on page 39.
I	<ETX>	<ETX> (03H) character
J	Checksum	Four ASCII digits that represent a 16-bit hexadecimal summation of all transmitted data from the previous <STX> through the previous <ETX> inclusive. The most significant digit is first.
K	<EOT>	<EOT> (04H) character

## 6.5 LARGE DOTS PICTURE file commands

SPECIAL NOTE
<p>The size of an LARGE DOTS PICTURE file can be up to 65535 x 65535 pixels.</p> <p>Only Alpha 7000, full matrix AlphaVision, AlphaPremiere, and AlphaEclipse signs support LARGE DOTS PICTURE files.</p>

LARGE DOTS PICTURE files are used to store dot patterns which are displayed by “calling” a picture file from a TEXT file. See “Call LARGE DOTS PICTURE” file in “Control codes (00 – 1FH)” on page 81.

The main purpose of LARGE DOTS PICTURE files is to display large (up to 65535 x 65535 pixels) graphics.

When a LARGE DOTS PICTURE file is written to a sign, the sign will go blank until the transmission is complete.

When reading from a LARGE DOTS PICTURE file, once the transmission packet has been sent, a sign will either pause or blank, depending on the type of sign. Once a sign has completely transmitted the file, the sign will continue displaying the message from where it was interrupted.

### 6.5.1 Write LARGE DOTS PICTURE file Command Code — “M” (4DH)

Table 25: Write LARGE DOTS PICTURE file transmission packet format

Standard transmission packet (see page 10)	<NUL> ^@	<NUL> ^@	<NUL> ^@	<NUL> ^@	<NUL> ^@	<SOH> ^A	Type Code	Sign Address	<STX> ^B	<b>Command Code</b>	<b>Data Field</b>	<EOT> ^D
--	-------------	-------------	-------------	-------------	-------------	-------------	-----------	--------------	-------------	---------------------	-------------------	-------------

4DH "M"	File Name	DOTS PICTURE File Data
------------	-----------	------------------------

A                      B

Height (y)	Width (x)	Row Bit Pattern	<CR> ^M	<LF> (optional) ^J
------------	-----------	-----------------	------------	-----------------------

C

These fields repeat y times.

Item	Name	Description											
A	Command Code	“M” (4DH) = Write LARGE DOTS PICTURE file											
B	File Name	Nine ASCII characters that indicate the LARGE DOTS PICTURE file being accessed.											
C	Data Field	<table border="1" style="width: 100%; border-collapse: collapse;"> <tr> <td style="width: 15%; text-align: center;">DOTS PICTURE File Data</td> <td style="width: 15%; text-align: center;">Height (y)</td> <td rowspan="5" style="vertical-align: top;">See “DOTS PICTURE File Data” in Table 22, “Write SMALL DOTS PICTURE file transmission packet format,” on page 39.</td> </tr> <tr> <td></td> <td style="text-align: center;">Width (x)</td> </tr> <tr> <td></td> <td style="text-align: center;">Row Bit Pattern</td> </tr> <tr> <td></td> <td style="text-align: center;">&lt;CR&gt;</td> </tr> <tr> <td></td> <td style="text-align: center;">&lt;LF&gt;</td> </tr> </table>	DOTS PICTURE File Data	Height (y)	See “DOTS PICTURE File Data” in Table 22, “Write SMALL DOTS PICTURE file transmission packet format,” on page 39.		Width (x)		Row Bit Pattern		<CR>		<LF>
DOTS PICTURE File Data	Height (y)	See “DOTS PICTURE File Data” in Table 22, “Write SMALL DOTS PICTURE file transmission packet format,” on page 39.											
	Width (x)												
	Row Bit Pattern												
	<CR>												
	<LF>												

**6.5.2 Read LARGE DOTS PICTURE file Command Code — “N” (4EH)**

NOTE: Whenever doing a “Read” command on a network with multiple signs, it’s important that each sign has a unique Serial Address. Also, only one sign at a time should be read from.

**Table 26: Read LARGE DOTS PICTURE file transmission packet format**

Standard transmission packet (see page 10)	<NUL> ^@	<NUL> ^@	<NUL> ^@	<NUL> ^@	<NUL> ^@	<SOH> ^A	Type Code	Sign Address	<STX> ^B	<b>Command Code</b>	<b>Data Field</b>	<EOT> ^D	
											4EH "N"	File Name	
											A	B	

Item	Name	Description
A	Command Code	"N" (4EH) = Read LARGE DOTS PICTURE file
B	Data Field File Name	Nine ASCII characters that indicate the LARGE DOTS PICTURE file being accessed.

Following the Read LARGE DOTS PICTURE file Command Code, a sign will respond with the following:

**Table 27: Read LARGE DOTS PICTURE file sign response packet format**

	<NUL> ^@	...	<NUL> ^@	<SOH> ^A	Type Code 30H "0"	Sign Address 30H 30H "00"	<STX> ^B	Command Code 4DH "M"	File Label	DOTS PICTURE File Data	<ETX> ^C	Checksum	<EOT> ^D
	A			B	C	D	E	F	G	H	I	J	K

Item	Name	Description
A	<NUL>	Twenty <NUL>s (00H) characters
B	<SOH>	<SOH> (01H) character
C	Type Code	"0" (30H) is the Response code
D	Sign Address	"00" (30H + 30H) is sent regardless of the sign's actual address.
E	<STX>	<STX> (02H) character
F	Command Code	"M" (4DH) is returned by the sign. (This is the Write LARGE DOTS PICTURE file Command Code.)
G	File Name	One ASCII character that indicates the DOTS PICTURE file being accessed. See "Appendix A: Valid File Labels" on page 50.
H	DOTS PICTURE File Data	See Table 22, "Write SMALL DOTS PICTURE file transmission packet format," on page 39.
I	<ETX>	<ETX> (03H) character
J	Checksum	Four ASCII digits that represent a 16-bit hexadecimal summation of all transmitted data from the previous <STX> through the previous <ETX> inclusive. The most significant digit is first.
K	<EOT>	<EOT> (04H) character

## 6.6 RGB DOTS PICTURE file commands

SPECIAL NOTE
The size of an RGB DOTS PICTURE file can be up to 65535 x 65535 pixels.
Only AlphaEclipse 3600 signs support RGB DOTS PICTURE files.

RGB DOTS PICTURE files are used to store RGB color dot patterns which are displayed by “calling” a picture file from a TEXT file. See “Call LARGE DOTS PICTURE” file in “Control codes (00 – 1FH)” on page 81.

The main purpose of RGB DOTS PICTURE files is to display RGB (Red-Green-Blue) graphics which could potentially have over 16 million colors.

When reading an RGB DOTS PICTURE file, the information on a sign will pause until the entire file has been received. Once a sign has completely transmitted the file, the sign will continue displaying the message from where it was interrupted.

### 6.6.1 Write RGB DOTS PICTURE file Command Code — “K” (4BH)

Table 28: Write RGB DOTS PICTURE file transmission packet format

Standard transmission packet (see page 10)	<NUL> ^@	<NUL> ^@	<NUL> ^@	<NUL> ^@	<NUL> ^@	<SOH> ^A	Type Code	Sign Address	<STX> ^B	<b>Command Code</b>	<b>Data Field</b>	<EOT> ^D
--	-------------	-------------	-------------	-------------	-------------	-------------	-----------	--------------	-------------	---------------------	-------------------	-------------

4BH "K"	File Label	DOTS PICTURE File Data
A	B	

  

Height (y)	Width (x)	Row Bit Pattern	<CR> ^M	<LF> (optional) ^J
These fields repeat y times.				
C				

Item	Name	Description
A	Command Code	"K" (4BH) = Write RGB DOTS PICTURE file
B	File Label	One ASCII character that indicates the RGB DOTS PICTURE file accessed. See "Appendix A: Valid File Labels" on page 50.
C	Data Field	DOTS PICTURE File Data
		Height (y)
	Width (x)	Four ASCII hexadecimal bytes that represent the number (0 to 65535) of pixel columns in a RGB DOTS PICTURE. This must match the pixel column bytes set up using "Set LARGE DOTS PICTURE Memory Configuration" (see page 26).  <b>NOTE:</b> Following the Width bytes, there should be at least a 100 millisecond delay (not to exceed the timeout period) before sending the Row Bit Pattern.

**Table 28: Write RGB DOTS PICTURE file transmission packet format**

<p style="text-align: center;"><b>C</b> (cont)</p>	<p style="text-align: center;">Data Field (cont)</p>	<p style="text-align: center;">DOTS PICTURE File Data (cont)</p>	<p style="text-align: center;"><sup>1</sup>Row Bit Pattern</p>	<p>The Width (x) number of ASCII characters which represent all the pixels in a row. The first ASCII character = the leftmost pixel in the row, the 2nd ASCII character = the next pixel in the row, etc. (see example below).</p> <p>Each RGB pixel is represented by six, ASCII hexadecimal characters in the format: RRGGBB where</p> <ul style="list-style-type: none"> <li>• RR = a Red color value from "00" to "FF"</li> <li>• GG = a Green color value from "00" to "FF"</li> <li>• BB = a Blue color value from "00" to "FF"</li> </ul> <p>To draw a small (4 pixels high x 7 pixels wide) RGB DOTS PICTURE like this . . .</p>  <p>. . . the RGB DOTS PICTURE File Data would look like this:</p> <table border="1" data-bbox="812 693 1201 766"> <tr> <th>Height (y)</th> <th>Width (x)</th> <th>Row Bit Pattern</th> <th>&lt;CR&gt; ^M</th> <th>&lt;LF&gt; (optional) ^J</th> </tr> </table> <pre data-bbox="730 798 1429 966"> "04"      "07" "000000 000000 000000 FF0000 000000 000000 000000"&lt;CR&gt;&lt;LF&gt; "000000 000000 FF0000 000000 00FF00 000000 000000"&lt;CR&gt;&lt;LF&gt; "000000 FF0000 000000 000000 000000 00FF00 000000"&lt;CR&gt;&lt;LF&gt; "FF0000 0000FF 0000FF 0000FF 0000FF 00FF00"&lt;CR&gt;&lt;LF&gt;     </pre> <p>Each pixel is represented by a 6-byte RGB color. (The added space between each byte is for ease of reading only.)</p> <p>Row delimiter character &lt;CR&gt; (ODH). The last &lt;CR&gt; is optional.</p> <p>If &lt;LF&gt;s are sent, they will <u>not</u> be sent back in a Read RGB DOTS PICTURE response. (See "Read SMALL DOTS PICTURE file Command Code — "J" (4AH)" on page 41.)</p> <p><b>NOTE:</b> If the number of row pixel characters is <i>greater than</i> the Width (x), then the extra row pixel characters will be ignored. If the number of row pixel characters is <i>less than</i> the Width (x), then the remaining row pixel characters will be turned off ("0").</p> <p><b>NOTE:</b> Since each LED pixel on a sign must be represented by a 6-byte RGB code, a large graphic could take a significant amount of time before it is displayed on a sign. For example, a 32 x 64 sign has 2048 pixels. An RGB graphic that size would equal 12,288 bytes (2048 x 6). If this RGB graphic was transmitted to a sign at a baud rate of 38,400 (or 4800 bytes/sec), then the sign would need about 2.5 seconds (12,288 / 4800) to display the graphic.</p>	Height (y)	Width (x)	Row Bit Pattern	<CR> ^M	<LF> (optional) ^J
				Height (y)	Width (x)	Row Bit Pattern	<CR> ^M	<LF> (optional) ^J	
<p><b>NOTE:</b> <sup>1</sup> DATA COMPRESSION — Row Bit Pattern can be data compressed as follows for RGB DOTS PICTURE files. Data compression can be done anywhere within the Row Bit Pattern. The format for data compression is: &lt;CTR-Q&gt;XXRRGGBB where:</p> <p>&lt;CTR-Q&gt; = 11H          XX = Two ASCII hexadecimal characters from "00" to "FF" that stand for the number of times + 1 to repeat RRGGBB (the RGB pixel color). For example, a value of "0A" (10) means repeat 10 + 1 = 11 times.          RRGGBB = RGB pixel color. Valid values are shown in Row Bit Pattern field above.</p>									

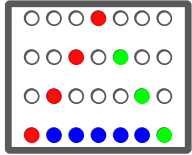
### 6.6.2 Read RGB DOTS PICTURE file Command Code — “L” (4CH)

NOTE: Whenever doing a “Read” command on a network with multiple signs, it is important that each sign has a unique Serial Address. Also, only one sign at a time should be read from.

**Table 29: Read RGB DOTS PICTURE file transmission packet format**

Standard transmission packet (see page 10)	<NUL> ^@	<NUL> ^@	<NUL> ^@	<NUL> ^@	<NUL> ^@	<SOH> ^A	Type Code	Sign Address	<STX> ^B	<b>Command Code</b>	<b>Data Field</b>	<EOT> ^D	
											4CH "L"	File Name	
											A	B	

Item	Name	Description
A	Command Code	"L" (4CH) = Read RGB DOTS PICTURE file
B	Data Field File Name	Nine ASCII characters that indicate the RGB DOTS PICTURE file being read.

Following the Read LARGE DOTS PICTURE file Command Code, a sign will respond with the following:

**Table 30: Read RGB DOTS PICTURE file sign response packet format**

<NUL> ^@	...	<NUL> ^@	<SOH> ^A	Type Code 30H "0"	Sign Address 30H 30H "00"	<STX> ^B	Command Code 4BH "K"	File Label	DOTS PICTURE File Data	<ETX> ^C	Checksum	<EOT> ^D
A			B	C	D	E	F	G	H	I	J	K

Item	Name	Description
A	<NUL>	Twenty <NUL>s (00H) characters
B	<SOH>	<SOH> (01H) character
C	Type Code	"0" (30H) is the Response code
D	Sign Address	"00" (30H + 30H) is sent regardless of the sign's actual address.
E	<STX>	<STX> (02H) character
F	Command Code	"K" (4BH) is returned by the sign. (This is the Write RGB DOTS PICTURE file Command Code.)
G	File Name	One ASCII character that indicates the DOTS PICTURE file being accessed. See "Appendix A: Valid File Labels" on page 50.
H	DOTS PICTURE File Data	See Table 28, "Write RGB DOTS PICTURE file transmission packet format," on page 44.
I	<ETX>	<ETX> (03H) character
J	Checksum	Four ASCII digits that represent a 16-bit hexadecimal summation of all transmitted data from the previous <STX> through the previous <ETX> inclusive. The most significant digit is first.
K	<EOT>	<EOT> (04H) character

### 6.6.3 RGB color chart

This chart of 216 RGB colors will render color accurately on almost any computer monitor that can display at least 256 colors.

In the chart, each color is defined by a hexadecimal and a decimal number. For example, the color in the uppermost left corner has a RGB hexadecimal value of "990033" and decimal values of "153", "000", and "051":

- Red value = 99H, 153D
- Green value = 00H, 0D
- Blue value = 33H, 51D

NOTE: This chart represents a small percentage of the possible 16,777,216 (256 x 256 x 256) RGB color combinations.

990033 R: 153 G: 000 B: 051	FF3366 R: 255 G: 051 B: 102	CC0033 R: 204 G: 000 B: 051	FF0033 R: 255 G: 000 B: 051	FF9999 R: 255 G: 153 B: 153	CC3366 R: 204 G: 051 B: 102	FFCCFF R: 255 G: 204 B: 255	CC6699 R: 204 G: 051 B: 153	993366 R: 153 G: 051 B: 102	660033 R: 102 G: 000 B: 051	CC3399 R: 204 G: 051 B: 153	FF99CC R: 255 G: 153 B: 204	FF66CC R: 255 G: 102 B: 204	FF99FF R: 255 G: 153 B: 255	FF6699 R: 255 G: 102 B: 153	CC0066 R: 204 G: 000 B: 102
FF0066 R: 255 G: 000 B: 102	FF3399 R: 255 G: 051 B: 153	FF0099 R: 255 G: 000 B: 153	FF33CC R: 255 G: 051 B: 204	FF00CC R: 255 G: 000 B: 204	FF66FF R: 255 G: 102 B: 255	FF33FF R: 255 G: 051 B: 255	FF00FF R: 255 G: 000 B: 255	CC0099 R: 204 G: 000 B: 153	990066 R: 153 G: 000 B: 102	CC66CC R: 204 G: 102 B: 204	CC33CC R: 204 G: 051 B: 204	CC99FF R: 204 G: 153 B: 255	CC66FF R: 204 G: 102 B: 255	CC33FF R: 204 G: 051 B: 255	993399 R: 153 G: 051 B: 153
CC00CC R: 204 G: 000 B: 204	CC00FF R: 204 G: 000 B: 255	9900CC R: 153 G: 000 B: 204	990099 R: 153 G: 000 B: 153	CC99CC R: 204 G: 153 B: 204	996699 R: 153 G: 102 B: 153	663366 R: 102 G: 051 B: 102	660099 R: 102 G: 000 B: 153	9933CC R: 153 G: 051 B: 204	660066 R: 102 G: 000 B: 102	9900FF R: 153 G: 000 B: 255	9933FF R: 153 G: 051 B: 255	9966CC R: 153 G: 102 B: 204	330033 R: 051 G: 000 B: 051	663399 R: 102 G: 051 B: 153	6633CC R: 102 G: 051 B: 204
6600CC R: 102 G: 000 B: 204	9966FF R: 153 G: 102 B: 255	330066 R: 051 G: 000 B: 102	6600FF R: 102 G: 000 B: 255	6633FF R: 102 G: 051 B: 255	CCCCFF R: 204 G: 204 B: 255	9999FF R: 153 G: 153 B: 255	9999CC R: 153 G: 153 B: 204	6666CC R: 102 G: 102 B: 204	6666FF R: 102 G: 102 B: 255	666699 R: 102 G: 102 B: 153	333366 R: 051 G: 051 B: 102	333399 R: 051 G: 051 B: 153	330099 R: 051 G: 000 B: 153	3300CC R: 051 G: 000 B: 204	3300FF R: 051 G: 000 B: 255
3333FF R: 102 G: 051 B: 255	3333CC R: 102 G: 051 B: 204	0066FF R: 000 G: 102 B: 255	0033FF R: 000 G: 051 B: 255	3366FF R: 051 G: 102 B: 255	3366CC R: 051 G: 102 B: 204	000066 R: 000 G: 000 B: 102	000033 R: 000 G: 000 B: 051	0000FF R: 000 G: 000 B: 255	000099 R: 000 G: 000 B: 153	0033CC R: 000 G: 051 B: 204	0000CC R: 000 G: 000 B: 204	336699 R: 102 G: 102 B: 153	0066CC R: 000 G: 102 B: 204	99CCFF R: 153 G: 204 B: 255	6699FF R: 102 G: 153 B: 255
003366 R: 000 G: 051 B: 102	6699CC R: 102 G: 153 B: 204	006699 R: 000 G: 102 B: 153	3399CC R: 051 G: 153 B: 204	0099CC R: 000 G: 153 B: 204	66CCFF R: 102 G: 204 B: 255	3399FF R: 051 G: 153 B: 255	003399 R: 000 G: 051 B: 153	0099FF R: 000 G: 153 B: 255	33CCFF R: 051 G: 204 B: 255	00CCFF R: 000 G: 204 B: 255	99FFFF R: 153 G: 255 B: 255	66FFFF R: 102 G: 255 B: 255	33FFFF R: 051 G: 255 B: 255	00FFFF R: 000 G: 255 B: 255	00CCCC R: 000 G: 204 B: 204
009999 R: 000 G: 153 B: 153	669999 R: 102 G: 153 B: 153	99CCCC R: 153 G: 204 B: 204	CCFFCC R: 204 G: 255 B: 255	33CCCC R: 051 G: 204 B: 204	66CCCC R: 102 G: 204 B: 204	339999 R: 051 G: 153 B: 153	336666 R: 051 G: 102 B: 102	006666 R: 000 G: 102 B: 102	003333 R: 000 G: 051 B: 051	00FFCC R: 000 G: 255 B: 204	33FFCC R: 051 G: 255 B: 204	33CC99 R: 051 G: 204 B: 153	00CC99 R: 000 G: 204 B: 153	66FFCC R: 102 G: 255 B: 204	99FFCC R: 153 G: 255 B: 204
00FF99 R: 000 G: 255 B: 153	339966 R: 051 G: 153 B: 102	006633 R: 000 G: 102 B: 051	336633 R: 051 G: 102 B: 051	669966 R: 102 G: 153 B: 102	66CC66 R: 102 G: 204 B: 102	99FF99 R: 153 G: 255 B: 153	66FF66 R: 102 G: 255 B: 102	339933 R: 051 G: 153 B: 051	99CC99 R: 153 G: 204 B: 153	66FF99 R: 102 G: 255 B: 153	33FF99 R: 051 G: 255 B: 153	33CC66 R: 051 G: 204 B: 102	00CC66 R: 000 G: 204 B: 102	66CC99 R: 102 G: 204 B: 153	009966 R: 000 G: 153 B: 102
009933 R: 000 G: 051 B: 051	33FF66 R: 051 G: 255 B: 102	00FF66 R: 000 G: 255 B: 102	CCFFCC R: 204 G: 255 B: 204	CCFF99 R: 204 G: 255 B: 153	99FF66 R: 153 G: 255 B: 102	99FF33 R: 153 G: 255 B: 051	00FF33 R: 000 G: 255 B: 051	33FF33 R: 051 G: 255 B: 051	00CC33 R: 000 G: 204 B: 051	33CC33 R: 051 G: 204 B: 051	66FF33 R: 102 G: 255 B: 051	00FF00 R: 000 G: 255 B: 000	66CC33 R: 102 G: 204 B: 051	006600 R: 000 G: 102 B: 000	003300 R: 000 G: 051 B: 000
009900 R: 000 G: 153 B: 000	33FF00 R: 051 G: 255 B: 000	66FF00 R: 102 G: 255 B: 000	99FF00 R: 153 G: 255 B: 000	66CC00 R: 102 G: 204 B: 000	00CC00 R: 000 G: 204 B: 000	33CC00 R: 051 G: 204 B: 000	339900 R: 051 G: 153 B: 000	99CC66 R: 153 G: 204 B: 102	669933 R: 102 G: 153 B: 051	99CC33 R: 153 G: 204 B: 051	336600 R: 051 G: 102 B: 000	669900 R: 102 G: 153 B: 000	99CC00 R: 153 G: 204 B: 000	CCFF66 R: 204 G: 255 B: 102	CCFF33 R: 204 G: 255 B: 051
CCFF00 R: 204 G: 255 B: 000	999900 R: 153 G: 204 B: 000	CCCC00 R: 204 G: 204 B: 000	CCCC33 R: 204 G: 204 B: 051	333300 R: 051 G: 051 B: 000	666600 R: 102 G: 102 B: 000	999933 R: 153 G: 153 B: 051	CCCC66 R: 204 G: 204 B: 102	666633 R: 102 G: 102 B: 051	999966 R: 153 G: 153 B: 102	CCCC99 R: 204 G: 204 B: 153	FFFFCC R: 255 G: 255 B: 204	FFFF99 R: 255 G: 255 B: 153	FFFF66 R: 255 G: 255 B: 102	FFFF33 R: 255 G: 255 B: 051	FFFF00 R: 255 G: 255 B: 000
FFCC00 R: 255 G: 204 B: 000	FFCC66 R: 255 G: 204 B: 102	FFCC33 R: 255 G: 204 B: 051	CC9933 R: 204 G: 153 B: 051	996600 R: 153 G: 102 B: 000	CC9900 R: 204 G: 153 B: 000	FF9900 R: 255 G: 153 B: 000	CC6600 R: 204 G: 102 B: 000	993300 R: 153 G: 051 B: 000	CC6633 R: 204 G: 102 B: 051	663300 R: 102 G: 051 B: 000	FF9966 R: 255 G: 153 B: 102	FF6633 R: 255 G: 102 B: 051	FF6600 R: 255 G: 102 B: 000	FF6600 R: 255 G: 102 B: 000	CC3300 R: 204 G: 051 B: 000
996633 R: 153 G: 102 B: 051	330000 R: 051 G: 000 B: 000	663333 R: 102 G: 051 B: 051	996666 R: 153 G: 102 B: 102	CC9999 R: 204 G: 153 B: 153	993333 R: 153 G: 051 B: 051	CC6666 R: 204 G: 102 B: 102	FFCCCC R: 255 G: 204 B: 204	FF3333 R: 255 G: 051 B: 051	CC3333 R: 204 G: 051 B: 051	FF6666 R: 255 G: 102 B: 102	660000 R: 102 G: 000 B: 000	990000 R: 153 G: 000 B: 000	CC0000 R: 204 G: 000 B: 000	FF0000 R: 255 G: 000 B: 000	FF3300 R: 255 G: 051 B: 000
CC9966 R: 204 G: 153 B: 102	FFCC99 R: 255 G: 204 B: 153	FFFFFF R: 255 G: 255 B: 255	CCCCCC R: 204 G: 204 B: 204	999999 R: 153 G: 153 B: 153	666666 R: 102 G: 102 B: 102	333333 R: 051 G: 051 B: 051	000000 R: 000 G: 000 B: 000								

## 6.7 ALPHAVISION BULLETIN MESSAGE file commands

An ALPHAVISION BULLETIN MESSAGE allows a text message of up to 225 characters to be rotated on a sign's display without interrupting the current operation.

### 6.7.1 Write ALPHAVISION BULLETIN MESSAGE file Command Code — "0" (4FH)

Only AlphaVision and Series 7000 signs support this command.

NOTE: Only the size of the ALPHAVISION BULLETIN MESSAGE window is cleared, not the entire line.

NOTE: Only seven high characters are supported.

NOTE: Only AlphaVision signs support the ability to vary window Position and Justification. An Alpha Series 7000 sign displays an ALPHAVISION BULLETIN MESSAGE across the entire width of the sign.

**Table 31: Write ALPHAVISION BULLETIN MESSAGE file transmission packet format**

Standard transmission packet (see page 10)	<NUL> ^@	<NUL> ^@	<NUL> ^@	<NUL> ^@	<NUL> ^@	<SOH> ^A	Type Code	Sign Address	<STX> ^B	Command Code	Data Field	<EOT> ^D				
											4FH "0"	Position	Justification	Width	Count	Text
											A	B				
Item	Name		Description													
A	Command Code		"0" (4FH) = Write ALPHAVISION BULLETIN MESSAGE file													
B	Data Field	Position	One ASCII character that stands for the position of the bulletin message on a sign. Valid values are: "T" 54H = Top of the display "B" 42H = Bottom of the display													
		Justification	One ASCII character that stands for the alignment of the bulletin message on a sign. Valid values are: "L" 4CH = Left side of the display "C" 43H = Center of the display "R" 52H = Right side of the display													
		Width	Two ASCII hexadecimal digits that specify the total number of characters in the Text field below. This number will be rounded up to the nearest 32-column width. For example, if the total number of characters = 78, this number would be rounded up to 32 x 3 = 96. The maximum Width is 255 ("FF").													
		Count	Two ASCII hexadecimal digits that stand for the number of times the bulletin message should be displayed.													
		Text	Up to 225 ASCII characters that comprise the actual bulletin message itself. Messages longer than 225 characters will be truncated.  NOTE: The only ASCII Control characters allowed in a bulletin message are color codes. (For more information, see "Appendix G: Alpha protocol ASCII table" on page 81.)													



**6.7.2 Stop ALPHAVISION BULLETIN MESSAGE file Command Code — “OT” (4F + 54H)**

To stop an ALPHAVISION BULLETIN MESSAGE before the Count field (above) has been reached, use this Command Code:

**Table 32: Terminate ALPHAVISION BULLETIN MESSAGE file transmission packet format**

Standard transmission packet (see page 10)	<NUL> ^@	<NUL> ^@	<NUL> ^@	<NUL> ^@	<NUL> ^@	<SOH> ^A	Type Code	Sign Address	<STX> ^B	<b>Command Code</b>	<b>Data Field</b>	<EOT> ^D
										4FH "O"	54H "T"	
<b>A</b>	Command Code	"O" (4FH)										
<b>B</b>	Data Field	"T" (54H) is the termination character.										

## 7.0 Appendices

### 7.1 Appendix A: Valid File Labels

A File Label is a single ASCII character. Messages are stored in or retrieved from the memory file that is defined by this label in the Memory Configuration.

File Labels can be anywhere in the range 20H through 7EH inclusive.

The only special case occurs when File Label "0" (30H) is used for a Priority TEXT file (see "Priority TEXT files" on page 20) which is pre-configured as a set portion of memory outside of the Memory Pool.

**Table 33: Valid File Labels**

20H - sp	30H - "0"	40H - "@"	50H - "P"	60H - "`"	70H - "p"
21H - "!"	31H - "1"	41H - "A"	51H - "Q"	61H - "a"	71H - "q"
22H - ""	32H - "2"	42H - "B"	52H - "R"	62H - "b"	72H - "r"
23H - "#"	33H - "3"	43H - "C"	53H - "S"	63H - "c"	73H - "s"
24H - "\$"	34H - "4"	44H - "D"	54H - "T"	64H - "d"	74H - "t"
25H - "%"	35H - "5"	45H - "E"	55H - "U"	65H - "e"	75H - "u"
26H - "&"	36H - "6"	46H - "F"	56H - "V"	66H - "f"	76H - "v"
27H - ""	37H - "7"	47H - "G"	57H - "W"	67H - "g"	77H - "w"
28H - "("	38H - "8"	48H - "H"	58H - "X"	68H - "h"	78H - "x"
29H - ")"	39H - "9"	49H - "I"	59H - "Y"	69H - "i"	79H - "y"
2AH - "*"	3AH - "."	4AH - "J"	5AH - "Z"	6AH - "j"	7AH - "z"
2BH - "+"	3BH - ",'" "	4BH - "K"	5BH - "["	6BH - "k"	7BH - "{"
2CH - ",'" "	3CH - "<"	4CH - "L"	5CH - "\"	6CH - "l"	7CH - " "
2DH - "-"	3DH - "="	4DH - "M"	5DH - "]"	6DH - "m"	7DH - "}"
2EH - ":"	3EH - ">"	4EH - "N"	5EH - "ç"	6EH - "n"	7EH - 1/2 sp
2FH - "/"	3FH - "?"	4FH - "O"	5FH - "_"	6FH - "o"	7FH - reserved

NOTE: File Label "0" (30H) is used for a Priority TEXT file (see "Priority TEXT files" on page 20).

NOTE: File Label "0" (30H) and "?" (3FH) can not be used as STRING file labels.

NOTE: If the Counter feature ("Appendix C: Counter information" on page 52) of a sign is used, then File Labels "1" (31H) through "5" (35H) are reserved for Target files.

NOTE: sp = space  
1/2 sp = 1/2 space

## 7.2 Appendix B: Valid Start and Stop times

The Start and Stop times are represented in ASCII. For example, a 8:50 am time = 35H = "35" (the ASCII characters 33H and 35H). Stop Time is ignored when Start Time is set to *Always* (FF):

**Table 34: Valid TEXT file Start and Stop times**

12:00 a.m. - 00H	8:00 a.m. - 30H	4:00 p.m. - 60H
12:10 a.m. - 01H	8:10 a.m. - 31H	4:10 p.m. - 61H
12:20 a.m. - 02H	8:20 a.m. - 32H	4:20 p.m. - 62H
12:30 a.m. - 03H	8:30 a.m. - 33H	4:30 p.m. - 63H
12:40 a.m. - 04H	8:40 a.m. - 34H	4:40 p.m. - 64H
12:50 a.m. - 05H	8:50 a.m. - 35H	4:50 p.m. - 65H
1:00 a.m. - 06H	9:00 a.m. - 36H	5:00 p.m. - 66H
1:10 a.m. - 07H	9:10 a.m. - 37H	5:10 p.m. - 67H
1:20 a.m. - 08H	9:20 a.m. - 38H	5:20 p.m. - 68H
1:30 a.m. - 09H	9:30 a.m. - 39H	5:30 p.m. - 69H
1:40 a.m. - 0AH	9:40 a.m. - 3AH	5:40 p.m. - 6AH
1:50 a.m. - 0BH	9:50 a.m. - 3BH	5:50 p.m. - 6BH
2:00 a.m. - 0CH	10:00 a.m. - 3CH	6:00 p.m. - 6CH
2:10 a.m. - 0DH	10:10 a.m. - 3DH	6:10 p.m. - 6DH
2:20 a.m. - 0EH	10:20 a.m. - 3EH	6:20 p.m. - 6EH
2:30 a.m. - 0FH	10:30 a.m. - 3FH	6:30 p.m. - 6FH
2:40 a.m. - 10H	10:40 a.m. - 40H	6:40 p.m. - 70H
2:50 a.m. - 11H	10:50 a.m. - 41H	6:50 p.m. - 71H
3:00 a.m. - 12H	11:00 a.m. - 42H	7:00 p.m. - 72H
3:10 a.m. - 13H	11:10 a.m. - 43H	7:10 p.m. - 73H
3:20 a.m. - 14H	11:20 a.m. - 44H	7:20 p.m. - 74H
3:30 a.m. - 15H	11:30 a.m. - 45H	7:30 p.m. - 75H
3:40 a.m. - 16H	11:40 a.m. - 46H	7:40 p.m. - 76H
3:50 a.m. - 17H	11:50 a.m. - 47H	7:50 p.m. - 77H
4:00 a.m. - 18H	12:00 p.m. - 48H	8:00 p.m. - 78H
4:10 a.m. - 19H	12:10 p.m. - 49H	8:10 p.m. - 79H
4:20 a.m. - 1AH	12:20 p.m. - 4AH	8:20 p.m. - 7AH
4:30 a.m. - 1BH	12:30 p.m. - 4BH	8:30 p.m. - 7BH
4:40 a.m. - 1CH	12:40 p.m. - 4CH	8:40 p.m. - 7CH
4:50 a.m. - 1DH	12:50 p.m. - 4DH	8:50 p.m. - 7DH
5:00 a.m. - 1EH	1:00 p.m. - 4EH	9:00 p.m. - 7EH
5:10 a.m. - 1FH	1:10 p.m. - 4FH	9:10 p.m. - 7FH
5:20 a.m. - 20H	1:20 p.m. - 50H	9:20 p.m. - 80H
5:30 a.m. - 21H	1:30 p.m. - 51H	9:30 p.m. - 81H
5:40 a.m. - 22H	1:40 p.m. - 52H	9:40 p.m. - 82H
5:50 a.m. - 23H	1:50 p.m. - 53H	9:50 p.m. - 83H
6:00 a.m. - 24H	2:00 p.m. - 54H	10:00 p.m. - 84H
6:10 a.m. - 25H	2:10 p.m. - 55H	10:10 p.m. - 85H
6:20 a.m. - 26H	2:20 p.m. - 56H	10:20 p.m. - 86H
6:30 a.m. - 27H	2:30 p.m. - 57H	10:30 p.m. - 87H
6:40 a.m. - 28H	2:40 p.m. - 58H	10:40 p.m. - 88H
6:50 a.m. - 29H	2:50 p.m. - 59H	10:50 p.m. - 89H
7:00 a.m. - 2AH	3:00 p.m. - 5AH	11:00 p.m. - 8AH
7:10 a.m. - 2BH	3:10 p.m. - 5BH	11:10 p.m. - 8BH
7:20 a.m. - 2CH	3:20 p.m. - 5CH	11:20 p.m. - 8CH
7:30 a.m. - 2DH	3:30 p.m. - 5DH	11:30 p.m. - 8DH
7:40 a.m. - 2EH	3:40 p.m. - 5EH	11:40 p.m. - 8EH
7:50 a.m. - 2FH	3:50 p.m. - 5FH	11:50 p.m. - 8FH
ALL DAY - FDH	NEVER - FEH	ALWAYS - FFH

## 7.3 Appendix C: Counter information

NOTE: In order to use counters, a sign must have a counter firmware upgrade.

### 7.3.1 Displaying Counter values

#### SHOW ME

An example of displaying a Counter value is on page 67.

TEXT files can use Control codes to display counter values. (See “Counters” in the “Extended character set” in “Appendix G: Alpha protocol ASCII table” on page 81).

### 7.3.2 Setting up Counters

#### 7.3.2.1 Memory Configuration

The default Memory Configuration on EZ95 signs and all EZII signs *equipped with the counter upgrade* (in addition to the default TEXT file “A” and DOTS PICTURE file “A”) contains five TARGET TEXT files with labels “1” through “5”. Each file is set up with a keyboard status of “unlocked” and is 100 bytes in length (64H). The default Run Start Time for each is “Never” (FEH). It is important to keep in mind that when writing a new Memory Configuration that TEXT files “1” through “5” need to be included, as these are the TARGET files. (See “Set Memory Configuration” in “Write SPECIAL FUNCTION Command Code — “E” (45H)” on page 21.)

#### 7.3.2.2 Memory Dump

A Memory Dump response from a sign equipped with the counter upgrade also contains the counter information. (See “Memory Dump” in “Read SPECIAL FUNCTION Command Code — “F” (46H)” on page 29.)

#### 7.3.2.3 Run Sequence

It is important to set up a Run Sequence which runs according to the file run times. Also, all five Target File Labels (“1” through “5”) should always be included in the Run Sequence, along with other desired TEXT files. (See “Set Run Sequence” in “Write SPECIAL FUNCTION Command Code — “E” (45H)” on page 21.)

#### 7.3.2.4 Run Day Table

It is important to set up a Run Day Table which accounts for, in addition to all user TEXT files, the Target files. The default Start Day value for all Target TEXT files is “0” (Daily), and the default Stop Day value is “2” (ignored). (See “Set Run Day Table” in “Write SPECIAL FUNCTION Command Code — “E” (45H)” on page 21.)

## 7.4 Appendix D: STRING file notes

A STRING file is a short stream of data that is “called” from a TEXT file. A typical use of a STRING file would be to update a count (e.g., a count-down timer) that is continuously displayed on a sign.

### 7.4.1 Advantages of using STRING files

- When STRING files are used to update data on a sign, the sign won’t “blink” or flash during the update. (However, a sign will blink when TEXT files are updated.)
- Using STRING files saves sign memory. For example, if some important data is displayed multiple times within a TEXT file, this data only needs to be stored once in a STRING file, then “called” from the appropriate location within the TEXT file.

### 7.4.2 Using STRING files example

To use STRING files, there are three basic steps:

STEP 1 — Allocate memory in a sign for the STRING file (and the TEXT file that calls it).

STEP 2 — Write the TEXT file which calls the STRING file.

STEP 3 — Update the STRING file.

NOTE: The default character spacing is proportional, rather than fixed width. Because of this, a sign’s auto-centering will move the displayed data around with the changing character widths in order to keep the data centered.

To avoid this distracting data movement on a sign:

(a) always send the same number of characters in the STRING file data, and

(b) always use fixed width characters by embedding the following 2-byte sequence in your TEXT file *before* the STRING file call: 1EH (Control “^”) + 31H (“1”).

#### SPECIAL NOTE

STEP 1 and STEP 2 are used to initialize a STRING file.

STEP 3 is used to change the information in a STRING file once it has been initialized.

### 7.4.2.1 STEP 1 — Allocate memory for a STRING file (and the TEXT file that calls it)

To allocate memory for one STRING file and the TEXT file which calls the STRING file, the following transmission packet could be sent to a network of signs:

**Table 35: Using STRING files example: STEP 1**

This following is a Standard Transmission packet (see page 10):			
Item	Name	Value	Description
A	<NUL>	00H	These five <NUL>s cause a sign to lock onto a baud rate. (This is also called "autobauding".)
B	<SOH>	01H	Start Of Header character
C	Type Code	"Z"	This means that this transmission is directed to all the sign types (i.e., 430i, 4120R, etc.).
D	Sign Address	"00"	This means all signs on the network should "listen" to this transmission.
E	<STX>	02H	Start of TeXt character
F	Command Code	"E"	This is the "Write SPECIAL FUNCTIONs" Command Code. (See "SPECIAL FUNCTION commands" on page 21.)
G	Data Field	"\$AAU0400FF001BL00200000"	<p>"\$" (24H) is the Write SPECIAL FUNCTIONs Command Code for <b>Set Memory Configuration</b> (see Table 15, "Write SPECIAL FUNCTION Command Code format — "E" (45H)," on page 21).</p> <p>The remaining characters have the following meaning:</p> <ul style="list-style-type: none"> <li>"A" = File Label of the TEXT file which will "call" the STRING file</li> <li>"A" = TEXT File Type</li> <li>"U" = this TEXT file is Unlocked</li> <li>"0400" = the TEXT file size in hexadecimal ("0400" = 1024D)</li> <li>"FF" = the TEXT file's Start Time ("FF" = Always)</li> <li>"00" = the TEXT file's Stop Time (even though the TEXT message will always run, "00" must be included as padding)</li> <li>"1" = File Label of the STRING file</li> <li>"B" = STRING File Type</li> <li>"L" = this STRING file is Locked</li> <li>"0020" = the STRING file size in hexadecimal ("0020" = 32D).</li> <li>"0000" = padding</li> </ul>
H	<EOT>	04H	End Of Transmission character

**7.4.2.2 STEP 2 — Write the TEXT file which calls the STRING file**

After allocating memory for the TEXT and the STRING files, write the TEXT file which will call the STRING file:

**Table 36: Using STRING files example: STEP 2**

This following is a Standard Transmission packet (see page 10):

`<NUL><NUL><NUL><NUL><NUL><SOH>"Z00"<STX>"AA"<ESC>" bThe count is"<DLE>"1"<EOT>`

Item	Name	Value	Description
<b>A</b>	<NUL>	00H	These five <NUL>s cause a sign to lock onto a baud rate. (This is also called "autobauding".)
<b>B</b>	<SOH>	01H	Start Of Header character
<b>C</b>	Type Code	"Z"	This means that this transmission is directed to all the sign types (i.e., 430i, 4120R, etc.).
<b>D</b>	Sign Address	"00"	This means all signs on the network should "listen" to this transmission.
<b>E</b>	<STX>	02H	Start of TeXt character
<b>F</b>	Command Code	"A"	"A" (41H) is the "Write TEXT file" Command Code. (See Table 12, "Write TEXT file transmission packet format," on page 18.)
<b>G</b>	Data Field	"A"<ESC>" bThe count is "<DLE>"1"	The characters have the following meaning: "A" = File Label of the TEXT file which will include the STRING file "A" = TEXT File Type <ESC> (1BH) = signals the start of a Mode field " " (20H) = middle line position "b" = Hold Mode "The count is " = the text of this TEXT file <DLE> (10H) = Call STRING file "1" = the STRING File Label to call
<b>H</b>	<EOT>	04H	End Of Transmission character

**7.4.2.3 STEP 3 — Update the STRING file**

To update the STRING file data (e.g., "The count is 364"), this would be sent:

**Table 37: Using STRING files example: STEP 3**

This following is a Standard Transmission packet (see page 10):

`<NUL><NUL><NUL><NUL><NUL><SOH>"Z00"<STX>"G1364"<EOT>`

Item	Name	Value	Description
<b>A</b>	<NUL>	00H	These five <NUL>s cause a sign to lock onto a baud rate. (This is also called "autobauding".)
<b>B</b>	<SOH>	01H	Start Of Header character
<b>C</b>	Type Code	"Z"	This means that this transmission is directed to all the sign types (i.e., 430i, 4120R, etc.).
<b>D</b>	Sign Address	"00"	This means all signs on the network should "listen" to this transmission.
<b>E</b>	<STX>	02H	Start of TeXt character
<b>F</b>	Command Code	"G"	"G" (47H) is the "Write STRING file" Command Code. (See Table 19, "Write STRING file transmission packet format," on page 37.)
<b>G</b>	Data Field	"1364"	The characters have the following meaning: "1" = the STRING File Label to write to "364" = the STRING file data
<b>H</b>	<EOT>	04H	End Of Transmission character

## 7.5 Appendix E: Sample programs

Other sample programs will be included at Adaptive's FTP site:

[ftp://ftp.ams-i.com/alpha\\_protocol\\_examples/](ftp://ftp.ams-i.com/alpha_protocol_examples/).

### 7.5.1 Sample Visual BASIC program

```

VERSION 5.00
Object = "{648A5603-2C6E-101B-82B6-000000000014}#1.1#0"; "MSCOMM32.OCX"
Begin VB.Form Form1
    Caption       = "Form1"
    ClientHeight  = 1155
    ClientLeft    = 2940
    ClientTop     = 3885
    ClientWidth   = 4590
    LinkTopic     = "Form1"
    PaletteMode   = 1 'UseZOrder
    ScaleHeight   = 1155
    ScaleWidth    = 4590
    Begin VB.CommandButton SendMessage
        Caption       = "Send Message"
        Height        = 375
        Left          = 840
        TabIndex      = 1
        Top           = 600
        Width         = 3495
    End
    Begin VB.CommandButton SendConfig
        Caption       = "Send Configuration Table (Sign's File Directory)"
        Height        = 375
        Left          = 840
        TabIndex      = 0
        Top           = 120
        Width         = 3495
    End
    Begin MSCommLib.MSComm MSComm1
        Left          = 360
        Top           = 1440
        _ExtentX     = 1005
        _ExtentY     = 1005
        _Version     = 393216
        DTREnable    = -1 'True
    End
    Begin VB.Label Label2
        Caption       = "Step 2:"
        Height        = 255
        Left          = 120
        TabIndex      = 3
        Top           = 720
        Width         = 615
    End
    Begin VB.Label Label1
        Caption       = "Step 1:"
        Height        = 255
        Left          = 120
        TabIndex      = 2
        Top           = 240
        Width         = 735
    End
End
Attribute VB_Name = "Form1"
Attribute VB_GlobalNameSpace = False
Attribute VB_Creatable = False
Attribute VB_PredeclaredId = True
Attribute VB_Exposed = False
Private Sub SendConfig_Click()
    counter = 1 ' set the message counter to 1

    MSComm1.CommPort = 1 ' set the comport to 1

    MSComm1.Settings = "9600,e,7,1" ' 9600 baud, even parity, 7 data, and 1 stop
bit.

```



```

MSComm1.InputLen = 0 ' Tell the control to read entire buffer when Input is
used.

' Open the port.
MSComm1.PortOpen = True

'this is the actual sending part
MSComm1.Output = Chr$(1) 'Start of header

MSComm1.Output = "Z" 'All Alpha Sign Models

MSComm1.Output = "00" '00 = All Addresses listen...
' this can be replaced with 01 or 53 or
' any other specific address

MSComm1.Output = Chr$(2) 'Start of text

' send config table for 1 text file
MSComm1.Output = "E$AAU0100FF00"
'E = process a command
'$ = Command type: $ = Write config table command
'A = Type of file for this directory slot: A = Text file
'A = Label for the file (think of it as the file name)
'U = Keyboard Lock/Unlock flag: U = unlocked (accessible by keyboard)
'0100 = number of bytes for the file: 0100 = 256 bytes (100 hex)
'FF = Start time: FF = On Always
'00 = stop time: 00 = unused because of the FF in prior section

MSComm1.Output = Chr$(4) 'End of text

MSComm1.PortOpen = False 'close the port

End Sub

Private Sub SendMessage_Click()

MSComm1.PortOpen = True 'open the port again

'this is the actual sending part
MSComm1.Output = Chr$(1) 'Start of header

MSComm1.Output = "Z" 'All Alpha Sign Models

MSComm1.Output = "00" '00 = All Addresses listen...
' this can be replaced with 01 or 53 or
' any other specific address

MSComm1.Output = Chr$(2) 'Start of text

MSComm1.Output = "A" 'command type: A = write text file
MSComm1.Output = "A" 'file label: in this case label 'A'
MSComm1.Output = Chr$(27) 'ESC - first char of a mode
MSComm1.Output = Chr$(32) 'SPC - position code spc = middle
'can be replaced with 34 (top) 38 (bottom)
'or 48 (fill)
MSComm1.Output = "b" 'mode code: b = hold
'actual text.

MSComm1.Output = Chr$(28) 'color code
MSComm1.Output = "1" 'color = red

MSComm1.Output = "Msg Coun = " + Str$(counter)
MSComm1.Output = Chr$(4) 'end of transmission

'close the port
MSComm1.PortOpen = False

'increase the counter by one.
counter = counter + 1

End Sub

```

## 7.6 Appendix F: Protocol examples

NOTE: In the following examples, it is assumed that the Memory Configuration table (Table 15 on page 21) in each sign has already been set up properly.

### 7.6.1 Standard transmission packet examples

#### 7.6.1.1 Send a message to all signs on a network example

The following example will display “HELLO” on all signs attached to a network:

**Table 38: Send a message to all signs example**

Item	Name	Value	Description	
<b>A</b>	<NUL>	00H	These five <NUL>s cause a sign to lock onto a baud rate. (This is also called “autobauding”.)	
<b>B</b>	<SOH>	01H	Start Of Header character	
<b>C</b>	Type Code	“Z”	This means that this transmission is directed to all the sign types (i.e., 430i, 4120R, etc.).	
<b>D</b>	Sign Address	“00”	This means all signs on the network should “listen” to this transmission.	
<b>E</b>	<STX>	02H	Start of TeXt character	
<b>F</b>	Command Code	“A”	“A” (41H) is the “Write TEXT file” Command Code. (See Table 12, “Write TEXT file transmission packet format,” on page 18.)	
<b>G</b>	Data Field	File Label	“A”	File Label of the TEXT file
		ASCII Message	“HELLO”	The actual text to be displayed on a sign
<b>H</b>	<EOT>	04H	End Of Transmission character	

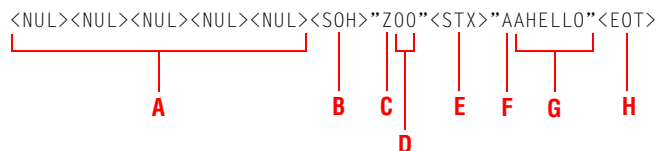

7.6.1.2 Send a message to all 1-line signs on a network with a Sign Address of 02H example

Table 39: Send a message to all 1-line signs on a network with a Sign Address of 02H example

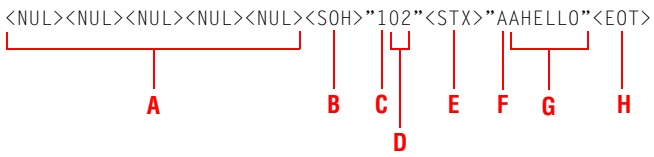
				
Item	Name	Value	Description	
A	<NUL>	00H	These five <NUL>s cause a sign to lock onto a baud rate. (This is also called "autobauding".)	
B	<SOH>	01H	Start Of Header character	
C	Type Code	"1"	This means that this transmission is directed to all 1-line signs.	
D	Sign Address	"02"	This means only 1-line signs with a Sign Address of 02H on the network should "listen" to this transmission.	
E	<STX>	02H	Start of TeXt character	
F	Command Code	"A"	"A" (41H) is the "Write TEXT file" Command Code. (See Table 12, "Write TEXT file transmission packet format," on page 18.)	
G	Data Field	File Label	"A"	File Label of the TEXT file
		ASCII Message	"HELLO"	The actual text to be displayed on a sign
H	<EOT>	04H	End Of Transmission character	

7.6.1.3 Send a message to all Series 7000 signs on a network with Sign Addresses 10H through 1FH example

Table 40: Send a message to all Series 7000 signs on a network with Sign Addresses 10H through 1FH example

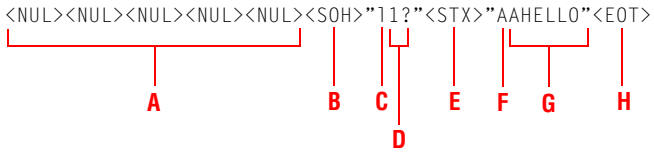
				
Item	Name	Value	Description	
A	<NUL>	00H	These five <NUL>s cause a sign to lock onto a baud rate. (This is also called "autobauding".)	
B	<SOH>	01H	Start Of Header character	
C	Type Code	"1"	"1" (6CH) means that this transmission is directed to all Series 7000 signs.	
D	Sign Address	"1?"	"1?" (31H 3FH) means only Series 7000 signs with Sign Addresses between 10H and 1FH inclusive on the network should "listen" to this transmission.	
E	<STX>	02H	Start of TeXt character	
F	Command Code	"A"	"A" (41H) is the "Write TEXT file" Command Code. (See Table 12, "Write TEXT file transmission packet format," on page 18.)	
G	Data Field	File Label	"A"	File Label of the TEXT file
		ASCII Message	"HELLO"	The actual text to be displayed on a sign
H	<EOT>	04H	End Of Transmission character	

### 7.6.2 Transmission packet with Checksum example

This example is identical to the previous example in Table 7.6.1.1, “Send a message to all signs on a network example,” on page 58 except that a Checksum is used in the following example:

**Table 41: Transmission packet with Checksum example**

Item	Name	Value	Description	
<b>A</b>	<NUL>	00H	These five <NUL>s cause a sign to lock onto a baud rate. (This is also called “autobauding”.)	
<b>B</b>	<SOH>	01H	Start Of Header character	
<b>C</b>	Type Code	“Z”	“Z” (5AH) means that this transmission is directed to all the sign types (i.e., 430i, 4120R, etc.).	
<b>D</b>	Sign Address	“00”	“00” (30H 30H) means all signs on the network should “listen” to this transmission.	
<b>E</b>	<STX>	02H	Start of TeXt character	
<b>F</b>	Command Code	“A”	“A” (41H) is the “Write TEXT file” Command Code. (See Table 12, “Write TEXT file transmission packet format,” on page 18.)	
<b>G</b>	Data Field	File Label	“A”	File Label of the TEXT file
		ASCII Message	“HELLO”	The actual text to be displayed on a sign
<b>H</b>	<ETX>	03H	End of TeXt (03H) character	
<b>I</b>	Checksum	“01FB”	Four ASCII digits that represent a 16-bit hexadecimal summation of all transmitted data from the previous <STX> (item E) through the previous <ETX> (item H) inclusive. The most significant digit is first.	
<b>J</b>	<EOT>	04H	End Of Transmission character	

7.6.3 Nesting with checksums transmission packet example

Table 42: Nesting with checksums transmission packet example

Item	Name	Value	Description	
<b>A</b>	<NUL>	00H	These five <NUL>s cause a sign to lock onto a baud rate. (This is also called "autobauding".)	
<b>B</b>	<SOH>	01H	Start Of Header character	
<b>C</b>	Type Code	"Z"	"Z" (5AH) means that this transmission is directed to all the sign types (i.e., 430i, 4120R, etc.).	
<b>D</b>	Sign Address	"00"	"00" (30H 30H) means all signs on the network should "listen" to this transmission.	
<b>E</b>	<STX>	02H	Start of Nested packet 1	
<b>F</b>	Command Code	"E"	"E" (45H) is the "Write SPECIAL FUNCTIONS" Command Code. (See Table 15, "Write SPECIAL FUNCTION Command Code format — "E" (45H)," on page 21.)	
<b>G</b>	Data Field	Special Functions Label	""	"" (27H) means Set Time Format
		Special Functions Data	"S"	"S" (53H) sets the sign's time to the standard am/pm format.
<b>H</b>	<ETX>	03H	End of Nested packet 1	
<b>I</b>	Checksum	"00C4"	Four ASCII digits that represent a 16-bit hexadecimal summation of all transmitted data from the previous <STX> (item E) through the previous <ETX> (item H) inclusive. The most significant digit is first.	
<b>J</b>	<STX>	02H	Start of Nested packet 2	
<b>K</b>	Command Code	"A"	"A" (41H) is the "Write TEXT file" Command Code. (See Table 12, "Write TEXT file transmission packet format," on page 18.)	
<b>L</b>	Data Field	File Label	"A"	File Label of the TEXT file
		ASCII Message	"HELLO"	The actual text to be displayed on a sign
<b>M</b>	<ETX>	03H	End of Nested packet 2	
<b>N</b>	Checksum	"01FB"	Four ASCII digits that represent a 16-bit hexadecimal summation of all transmitted data from the previous <STX> (item E) through the previous <ETX> (item H) inclusive. The most significant digit is first.	
<b>O</b>	<EOT>	04H	End Of Transmission character	

### 7.6.4 Nesting without Checksum transmission packet example

This packet is identical to the previous packet in Table 42 on page 61 except that the Checksums are omitted after each nested packet's <ETX>:

**Table 43: Nesting without Checksums transmission packet example**

Item	Name	Value	Description	
<b>A</b>	<NUL>	00H	These five <NUL>s cause a sign to lock onto a baud rate. (This is also called "autobauding".)	
<b>B</b>	<SOH>	01H	Start Of Header character	
<b>C</b>	Type Code	"Z"	"Z" (5AH) means that this transmission is directed to all the sign types (i.e., 430i, 4120R, etc.).	
<b>D</b>	Sign Address	"00"	"00" (30H 30H) means all signs on the network should "listen" to this transmission.	
<b>E</b>	<STX>	02H	Start of Nested packet 1	
<b>F</b>	Command Code	"E"	"E" (45H) is the "Write SPECIAL FUNCTIONS" Command Code. (See Table 15, "Write SPECIAL FUNCTION Command Code format — "E" (45H)," on page 21.)	
<b>G</b>	Data Field	Special Functions Label	""	"" (27H) means Set Time Format
		Special Functions Data	"S"	"S" (53H) sets the sign's time to the standard am/pm format.
<b>H</b>	<ETX>	03H	End of Nested packet 1	
<b>I</b>	<STX>	02H	Start of Nested packet 2	
<b>J</b>	Command Code	"A"	"A" (41H) is the "Write TEXT file" Command Code. (See Table 12, "Write TEXT file transmission packet format," on page 18.)	
<b>K</b>	Data Field	File Label	"A"	File Label of the TEXT file
		ASCII Message	"HELLO"	The actual text to be displayed on a sign
<b>L</b>	<ETX>	03H	End of Nested packet 2 (Optional when <EOT> is the next character.)	
<b>M</b>	<EOT>	04H	End Of Transmission character	

### 7.6.5 Multiple Type Codes / Sign Addresses example

In this example three Type Code/Sign Address pairs are shown:

NOTE: The effects of Type Codes are cumulative. For instance, in this example the message would be sent to all 4120C signs and Director signs and 790i signs on the network.

**Table 44: Multiple Type Codes / Sign Addresses example**

Item	Name	Value	Description
<b>A</b>	<NUL>	00H	These five <NUL>s cause a sign to lock onto a baud rate. (This is also called "autobauding".)
<b>B</b>	<SOH>	01H	Start Of Header character
<b>C</b>	Pair 1	Type Code	"a"
<b>D</b>		Sign Address	"01"
<b>E</b>	Delimiter		","
<b>F</b>	Pair 2	Type Code	"r"
<b>G</b>		Sign Address	"1?"
<b>H</b>	Delimiter		","
<b>I</b>	Pair 3	Type Code	"U"
<b>J</b>		Sign Address	"26"
<b>K</b>	<STX>	02H	Start of TeXt character
<b>L</b>	Command Code		"A"
<b>M</b>	Data Field	File Label	"A"
		ASCII Message	"HELLO"
<b>N</b>	<EOT>	04H	End Of Transmission character

### 7.6.6 TEXT file examples

#### 7.6.6.1 Read TEXT file example

The response to this read file request is shown in Table 46 on page 64.

**Table 45: Read TEXT file example**

Item	Name	Value	Description
A	<NUL>	00H	These five <NUL>s cause a sign to lock onto a baud rate. (This is also called "autobauding".)
B	<SOH>	01H	Start Of Header character
C	Type Code	"Z"	"Z" (5AH) means that this transmission is directed to all signs.
D	Sign Address	"06"	"06" (30H 36H) means only signs with a Sign Address of 06H on the network should "listen" to this transmission.
E	<STX>	02H	Start of TeXt character
F	Command Code	"B"	"B" (42H) is the "Read TEXT file" Command Code. (See Table 13, "Read TEXT file transmission packet format," on page 19.)
G	Data Field File Label	"C"	File Label of the TEXT file to read
H	<EOT>	04H	End Of Transmission character

#### 7.6.6.2 Response to Read TEXT file example

This is the response to the read file request shown in the Table 45 on page 64.

NOTE: For the sake of this example, we'll assume that the TEXT file with the File Label "C" just contains the text "FILE C".

**Table 46: Response to Read TEXT file example**

Item	Name	Value	Description
A	<NUL>	00H	Twenty <NUL> characters
B	<SOH>	01H	Start Of Header character
C	Type Code	"0"	The Response Type Code
D	Sign Address	"00"	"00" (30H 30H) is always sent.
E	<STX>	02H	Start of TeXt character
F	Command Code	"A"	"A" (41H) is sent in response to the "Read TEXT file" Command Code.
G	File Label	"C"	File Label of the TEXT file that is being read
H	TEXT file data format	"FILE C"	The actual text stored in TEXT file "C"
I	<ETX>	03H	End of TeXt character
J	Checksum	"020C"	Four ASCII digits that represent a 16-bit hexadecimal summation of all transmitted data from the previous <STX> (item E) through the previous <ETX> (item H) inclusive. The most significant digit is first.
K	<EOT>	04H	End Of Transmission character



**7.6.6.3 TEXT file data format examples**

**7.6.6.3.1 Rotate “Hello” example**

This example uses the Rotate Mode to move the text “HELLO” on the bottom line of a sign:

**Table 47: Rotate “Hello” example**

<code>&lt;NUL&gt;&lt;NUL&gt;&lt;NUL&gt;&lt;NUL&gt;&lt;NUL&gt;&lt;SOH&gt;”Z00”&lt;STX&gt;”AD”&lt;ESC&gt;”&amp;aHELLO”&lt;EOT&gt;</code>					
Item	Name	Value	Description		
<b>A</b>	<NUL>	00H	These five <NUL>s cause a sign to lock onto a baud rate. (This is also called “autobauding”.)		
<b>B</b>	<SOH>	01H	Start Of Header character		
<b>C</b>	Type Code	“Z”	“Z” (5AH) means that this transmission is directed to all signs.		
<b>D</b>	Sign Address	“00”	“00” (30H 30H) means all signs on the network should “listen” to this transmission.		
<b>E</b>	<STX>	02H	Start of TeXt character		
<b>F</b>	Command Code	“A”	“A” (41H) is the “Write TEXT file” Command Code. (See Table 12, “Write TEXT file transmission packet format,” on page 18.)		
<b>G</b>	Data Field	File Label	“D”	File Label of the TEXT file that will be written	
		Mode Field	<ESC>	1BH	Escape character
			Display Position	“&”	“&” (26H) means that the ASCII Message should be displayed on the bottom line of a sign.
			Mode Code	“a”	“a” (61H) Rotate code.
	ASCII Message	“HELLO”	The actual text to be displayed		
<b>H</b>	<EOT>	04H	End Of Transmission character		

**7.6.6.3.2 Combining text and graphics example**

**Table 48: Combining text and graphics example**

<code>&lt;NUL&gt;&lt;NUL&gt;&lt;NUL&gt;&lt;NUL&gt;&lt;NUL&gt;&lt;SOH&gt;”Z00”&lt;STX&gt;”A”&lt;ESC&gt;””n2Hel1o There”&lt;ESC&gt;””a”&lt;ESC&gt;”&amp;n8”&lt;EOT&gt;</code>			
Item	Name	Value	Description
<b>A</b>	<NUL>	00H	These five <NUL>s cause a sign to lock onto a baud rate. (This is also called “autobauding”.)
<b>B</b>	<SOH>	01H	Start Of Header character
<b>C</b>	Type Code	“Z”	“Z” (5AH) means that this transmission is directed to all signs.
<b>D</b>	Sign Address	“00”	“00” (30H 30H) means all signs on the network should “listen” to this transmission.
<b>E</b>	<STX>	02H	Start of TeXt character
<b>F</b>	Command Code	“A”	“A” (41H) is the “Write TEXT file” Command Code. (See Table 12, “Write TEXT file transmission packet format,” on page 18.)

**Table 48: Combining text and graphics example**

<b>G</b>	Data Field	TEXT file data format	File Label	">"	File Label of the TEXT file that will be written	
			Mode Field	<ESC>	<ESC>	<ESC> (1BH) always starts the Mode Field
				Display Position	""	"" (22H) means that the ASCII Message will begin on the Top Line of the sign
				Mode Code	"n"	"n" (6EH) is used in conjunction with the Special Specifier to use the Special Modes (see "The following would write a DOTS PICTURE file labeled "A", 15 pixel rows high x 9 pixel columns wide to a 4160C sign:" on page 76).
				Special Specifier	"2"	"2" (32H) means that the Special Mode called SNOW will be used.
		ASCII Message	"Hello There"	The actual text to be displayed		
		TEXT file data format	Mode Field	<ESC>	<ESC>	<ESC> (1BH) always starts the Mode Field
				Display Position	""	"" (22H) means the Top Line of the sign.
				Mode Code	"a"	"a" (61H) is the ROTATE Mode Code. This means that the previous ASCII Message ("Hello There") will be ROTATED off the Top Line of the sign. This is often referred to as a "Trailing Mode".
			ASCII Message		In this case, there is no ASCII Message because of the "trailing" ROTATE Mode.	
		TEXT file data format	Mode Field	<ESC>	<ESC>	<ESC> (1BH) always starts the Mode Field
				Display Position	"&"	"&" (22H) means that the ASCII Message will begin on the Bottom Line of the sign
				Mode Code	"n"	"n" (6EH) is used in conjunction with the Special Specifier to use the Special Modes (see "The following would write a DOTS PICTURE file labeled "A", 15 pixel rows high x 9 pixel columns wide to a 4160C sign:" on page 76).
			Special Specifier	"8"	"8" (38H) means that the Special Mode called WELCOME will be used.	
		ASCII Message		In this case, there is no ASCII Message because of the WELCOME animation.		
<b>H</b>		<EOT>	04H	End Of Transmission character		

7.6.6.3.3 Displaying a Counter value example

Table 49: Displaying a Counter value example

<pre>&lt;NUL&gt;&lt;NUL&gt;&lt;NUL&gt;&lt;NUL&gt;&lt;NUL&gt;&lt;SOH&gt;"h00"&lt;STX&gt;"A1"&lt;ESC&gt;"bCongratulations!"&lt;CR&gt;&lt;BS&gt;"z days without an accident!"&lt;EOT&gt;</pre>					
Item	Name	Value	Description		
A	<NUL>	00H	These five <NUL>s cause a sign to lock onto a baud rate. (This is also called "autobauding".)		
B	<SOH>	01H	Start Of Header character		
C	Type Code	"h"	"h" (68H) means that this transmission is directed to all 4160R signs.		
D	Sign Address	"00"	"00" (30H 30H) means all 4160R signs on the network should "listen" to this transmission.		
E	<STX>	02H	Start of TeXt character		
F	Command Code	"A"	"A" (41H) is the "Write TEXT file" Command Code. (See Table 12, "Write TEXT file transmission packet format," on page 18.)		
G	Data Field	File Label	"1"	File Label of the TEXT file	
		TEXT file data format	Mode Field	<ESC>	<ESC> (1BH) always starts the Mode Field
			Display Position	""	"" (22H) means that the ASCII Message will begin on the Top Line of the sign
			Mode Code	"b"	"b" (62H) is the HOLD Mode Code (see page 76)
	ASCII Message	"Congratulations"<CR><BS>"z days without an accident!"	The actual text (with Control Codes) to be displayed on a sign. These Control Codes are used: <CR> (0DH) = means that text after the <CR> will be on the next line of the sign <BS> (08H) + "z" = a 2-byte code used to display a counter, in this case Counter 1 (see "Appendix C: Counter information" on page 52).		
H	<EOT>	04H	End Of Transmission character		

### 7.6.7 Priority TEXT file examples

#### 7.6.7.1 Write a Priority TEXT file example

Table 50: Write a Priority TEXT file example

Item	Name	Value	Description		
A	<NUL>	00H	These five <NUL>s cause a sign to lock onto a baud rate. (This is also called "autobauding".)		
B	<SOH>	01H	Start Of Header character		
C	Type Code	"Z"	"Z" (5AH) means that this transmission is directed to all signs.		
D	Sign Address	"00"	"00" (30H 30H) means all signs on the network should "listen" to this transmission.		
E	<STX>	02H	Start of TeXt character		
F	Command Code	"A"	"A" (41H) is the "Write TEXT file" Command Code. (See Table 12, "Write TEXT file transmission packet format," on page 18.)		
G	Data Field	File Label	"0"	"0" (30H) Priority TEXT File Label	
		TEXT file data format	Mode Field	<ESC>	<ESC> (1BH) always starts the Mode Field
			Display Position	" "	" " (20H) means that the ASCII Message will be on the Middle Line of the sign
			Mode Code	"c"	"c" (62H) is the FLASH Mode Code (see page 76)
	ASCII Message	<SUB>"9EMERGENCY"	The actual text (with Control Codes) to be displayed on a sign. These Control Codes are used: <SUB> (1AH) + "9" = a 2-byte code used to select a character set, in this case Full Height Standard (see "Appendix G: Alpha protocol ASCII table" on page 81).		
H	<EOT>	04H	End Of Transmission character		

#### 7.6.7.2 Disable a Priority TEXT file example

The following transmission will disable the Priority TEXT file. Whatever was running on a sign *before* the Priority TEXT file was sent will resume running.

Table 51: Disable a Priority TEXT file example

Item	Name	Value	Description	
A	<NUL>	00H	These five <NUL>s cause a sign to lock onto a baud rate. (This is also called "autobauding".)	
B	<SOH>	01H	Start Of Header character	
C	Type Code	"Z"	"Z" (5AH) means that this transmission is directed to all signs.	
D	Sign Address	"00"	"00" (30H 30H) means all signs on the network should "listen" to this transmission.	
E	<STX>	02H	Start of TeXt character	
F	Command Code	"A"	"A" (41H) is the "Write TEXT file" Command Code. (See Table 12, "Write TEXT file transmission packet format," on page 18.)	
G	Data Field	File Label	"0"	"0" (30H) Priority TEXT File Label
H	<EOT>	04H	End Of Transmission character	

**7.6.8 SPECIAL FUNCTION examples**

**7.6.8.1 Write SPECIAL FUNCTION example**

The following sets the time on all networked signs to 2:30 pm (1430 in 24-hour format):

**Table 52: Write SPECIAL FUNCTION example**

Item	Name		Value	Description
<b>A</b>	<NUL>		00H	These five <NUL>s cause a sign to lock onto a baud rate. (This is also called "autobauding".)
<b>B</b>	<SOH>		01H	Start Of Header character
<b>C</b>	Type Code		"Z"	"Z" (5AH) means that this transmission is directed to all signs.
<b>D</b>	Sign Address		"00"	"00" (30H 30H) means all signs on the network should "listen" to this transmission.
<b>E</b>	<STX>		02H	Start of TeXt character
<b>F</b>	Command Code		"E"	"E" (45H) is the "Write SPECIAL FUNCTIONS file" Command Code. (See Table 15, "Write SPECIAL FUNCTION Command Code format — "E" (45H)," on page 21.)
<b>G</b>	Data Field	Special Functions Label	" "	" " (20H) = Set Time of Day
		Special Functions Data	"1430"	The time to set (in 24-hour format)
<b>H</b>	<EOT>		04H	End Of Transmission character

**7.6.8.2 Read SPECIAL FUNCTION example**

The following reads the day of week from a sign with a Sign Address of 4:

**Table 53: Read SPECIAL FUNCTION example**

Item	Name		Value	Description
<b>A</b>	<NUL>		00H	These five <NUL>s cause a sign to lock onto a baud rate. (This is also called "autobauding".)
<b>B</b>	<SOH>		01H	Start Of Header character
<b>C</b>	Type Code		"Z"	"Z" (5AH) means that this transmission is directed to all signs.
<b>D</b>	Sign Address		"04"	"04" (30H 34H) means all signs on the network should "listen" to this transmission.
<b>E</b>	<STX>		02H	Start of TeXt character
<b>F</b>	Command Code		"F"	"F" (46H) is the "Read SPECIAL FUNCTIONS file" Command Code. (See Table 16, "Read SPECIAL FUNCTION Command Code format — "F" (46H)," on page 29.)
<b>G</b>	Data Field	Special Functions Label	"&"	"&" (26H) Read Day of Week
<b>H</b>	<EOT>		04H	End Of Transmission character

**7.6.8.3 Response to Read SPECIAL FUNCTION example**

The following is the response to the Read SPECIAL FUNCTION example in Table 53 above:

**Table 54: Response to Read SPECIAL FUNCTION example**

Item	Name	Value	Description
<b>A</b>	<NUL>	00H	Twenty <NUL> (00H) characters
<b>B</b>	<SOH>	01H	Start Of Header character
<b>C</b>	Type Code	"0"	"0" (30H) is the Response code
<b>D</b>	Sign Address	"00"	"00" (30H 30H) is sent regardless of the sign's actual address.
<b>E</b>	<STX>	02H	Start of TeXt character
<b>F</b>	Command Code	"E"	"E" (45H) is the "Read SPECIAL FUNCTIONs file" Command Code. (See Table 16, "Read SPECIAL FUNCTION Command Code format — "F" (46H)," on page 29.)
<b>G</b>	Special Functions Label	"&"	"&" (26H) Read Day of Week
<b>H</b>	Special Functions Data	"6"	"6" (36H) stands for Friday
<b>I</b>	<ETX>	03H	End of TeXt character
<b>J</b>	Checksum	"00A6"	Four ASCII digits that represent a 16-bit hexadecimal summation of all transmitted data from the previous <STX> through the previous <ETX> inclusive. The most significant digit is first.
<b>K</b>	<EOT>	04H	End Of Transmission character

7.6.8.4 SPECIAL FUNCTION data formats example

7.6.8.4.1 Set Memory Configuration example #1 — Counter data not included

This example writes the following file information to all signs:

- a TEXT file “A”, unlocked, 265 (100H) bytes in length, to run always
- a DOTS PICTURE file “m”, unlocked, 7 x 60 (rows x columns), one color
- a STRING file “l”, locked, 10 bytes in length

Table 55: Set Memory Configuration example #1 — Counter data not included

Item	Name	Value	Description
A	<NUL>	00H	These five <NUL>s cause a sign to lock onto a baud rate. (This is also called “autobauding”.)
B	<SOH>	01H	Start Of Header character
C	Type Code	“Z”	“Z” (5AH) means that this transmission is directed to all the sign types (i.e., 430i, 4120R, etc.).
D	Sign Address	“00”	“00” (30H 30H) means all signs on the network should “listen” to this transmission.
E	<STX>	02H	Start of TeXt character
F	Command Code	“E”	“E” (45H) is the “Write SPECIAL FUNCTIONs file” Command Code. (See Table 15, “Write SPECIAL FUNCTION Command Code format — “E” (45H),” on page 21.)
G	Special Functions Label	“\$”	“\$” (24H) means Set Memory Configuration
H	Special Functions Data	TEXT file	“AAU0100FF00” These bytes mean the following: “A” = File Label “A” = file type (in this case, a STRING file) “U” = an unlocked file “0100” = the size of this file in bytes (256D) “FF” = the TEXT file’s Start Time (in this case Always) “00” = the TEXT file’s Stop Time (ignored when the Start Time is Always)
I		DOTS PICTURE file	“mDU073C1000” These bytes mean the following: “m” = File Label “D” = file type (in this case, a DOTS PICTURE file) “U” = an unlocked file “07” = number of pixel rows in the DOTS PICTURE file (7D) “3C” = number of pixel columns in the DOTS PICTURE file (60D) “1000” = a monochrome DOTS PICTURE file
J		STRING file	“lBL000A0000” These bytes mean the following: “l” = File Label “B” = file type (in this case, a TEXT file) “L” = a locked file “000A” = the size of this file in bytes (10D) “0000” = these are just placeholders for a STRING file
K	<EOT>	04H	End Of Transmission character

**7.6.8.4.2 Set Memory Configuration example #2 — Counter data included**

The Memory Configuration from the previous example (Table 55) is used. However, in this example, in order to use a sign’s Counters, the five Target files must be set up. (See also “Appendix C: Counter information” on page 52.)

NOTE: Once a Current Counter Value reaches its Counter Target Value, all Target files are triggered (as set up in the Target File Byte). This means that the Start Times for the appropriate Target files will be automatically set to Always.

**Table 56: Set Memory Configuration example #2 — Counter data included**

Item	Name	Value	Description
<b>A</b>	<NUL>	00H	These five <NUL>s cause a sign to lock onto a baud rate. (This is also called “autobauding”.)
<b>B</b>	<SOH>	01H	Start Of Header character
<b>C</b>	Type Code	“Z”	“Z” (5AH) means that this transmission is directed to all the sign types (i.e., 430i, 4120R, etc.).
<b>D</b>	Sign Address	“00”	“00” (30H 30H) means all signs on the network should “listen” to this transmission.
<b>E</b>	<STX>	02H	Start of TeXt character
<b>F</b>	Command Code	“E”	“E” (45H) is the “Write SPECIAL FUNCTIONS file” Command Code. (See Table 15, “Write SPECIAL FUNCTION Command Code format — “E” (45H),” on page 21.)
<b>G</b>	Special Functions Label	“\$”	“\$” (24H) means Set Memory Configuration
<b>H</b>	Special Functions Data	TEXT file	“AAU0100FF00” These bytes mean the following: “A” = File Label “A” = file type (in this case, a TEXT file) “U” = an unlocked file “0100” = the size of this file in bytes (256D) “FF” = the TEXT file’s Start Time (in this case Always) “00” = the TEXT file’s Stop Time (ignored when the Start Time is Always)
<b>I</b>		DOTS PICTURE file	“mDU073C1000” These bytes mean the following: “m” = File Label “D” = file type (in this case, a DOTS PICTURE file) “U” = an unlocked file “07” = number of pixel rows in the DOTS PICTURE file (7D) “3C” = number of pixel columns in the DOTS PICTURE file (60D) “1000” = a monochrome DOTS PICTURE file
<b>J</b>		STRING file	“lBL000A0000” These bytes mean the following: “l” = File Label “B” = file type (in this case, a STRING file) “L” = a locked file “000A” = the size of this file in bytes (10D) “0000” = these are just placeholders for a STRING file
<b>K</b>		TEXT file (this is the Target File for Counter 1)	“1AU0064FE00” These bytes mean the following: “1” = File Label for Counter 1 Target File “A” = file type (in this case, a TEXT file) “U” = an unlocked file “0064” = the size of this file in bytes (100D) “FE” = the TEXT file’s Start Time (in this case Never) “00” = the TEXT file’s Stop Time (ignored when the Start Time is Never)



**Table 56: Set Memory Configuration example #2 — Counter data included**

<b>L</b>	Special Functions Data (continued)	TEXT file (this is the Target File for Counter 2)	"2AU0064FE00"	These bytes mean the following: "2" = File Label for Counter 2 Target File "A" = file type (in this case, a TEXT file) "U" = an unlocked file "0064" = the size of this file in bytes (100D) "FE" = the TEXT file's Start Time (in this case Never) "00" = the TEXT file's Stop Time (ignored when the Start Time is Never)
<b>M</b>		TEXT file (this is the Target File for Counter 3)	"3AU0064FE00"	These bytes mean the following: "3" = File Label for Counter 3 Target File "A" = file type (in this case, a TEXT file) "U" = an unlocked file "0064" = the size of this file in bytes (100D) "FE" = the TEXT file's Start Time (in this case Never) "00" = the TEXT file's Stop Time (ignored when the Start Time is Never)
<b>N</b>		TEXT file (this is the Target File for Counter 4)	"4AU0064FE00"	These bytes mean the following: "4" = File Label for Counter 4 Target File "A" = file type (in this case, a TEXT file) "U" = an unlocked file "0064" = the size of this file in bytes (100D) "FE" = the TEXT file's Start Time (in this case Never) "00" = the TEXT file's Stop Time (ignored when the Start Time is Never)
<b>O</b>		TEXT file (this is the Target File for Counter 5)	"5AU0064FE00"	These bytes mean the following: "5" = File Label for Counter 5 Target File "A" = file type (in this case, a TEXT file) "U" = an unlocked file "0064" = the size of this file in bytes (100D) "FE" = the TEXT file's Start Time (in this case Never) "00" = the TEXT file's Stop Time (ignored when the Start Time is Never)
<b>P</b>		<EOT>	04H	End Of Transmission character

## 7.6.9 STRING file examples

### 7.6.9.1 Write STRING file example

Table 57: Write STRING file example

Item	Name	Value	Description
<b>A</b>	<NUL>	00H	These five <NUL>s cause a sign to lock onto a baud rate. (This is also called "autobauding".)
<b>B</b>	<SOH>	01H	Start Of Header character
<b>C</b>	Type Code	"Z"	"Z" (5AH) means that this transmission is directed to all signs.
<b>D</b>	Sign Address	"00"	"00" (30H 30H) means all signs on the network should "listen" to this transmission.
<b>E</b>	<STX>	02H	Start of TeXt character
<b>F</b>	Command Code	"G"	"G" (47H) is the "Write STRING file" Command Code. (See Table 19, "Write STRING file transmission packet format," on page 37.)
<b>G</b>	Data Field	File Label	"1" (31H) File Label of the STRING file
<b>H</b>	STRING File Data	"7,345"	This is the actual STRING file data.
<b>I</b>	<EOT>	04H	End Of Transmission character

<NUL><NUL><NUL><NUL><NUL><SOH>"Z00"<STX>"G17,345"<EOT>

7.6.9.2 Read STRING file example

Table 58: Read STRING file example

Item	Name	Value	Description
<b>A</b>	<NUL>	00H	These five <NUL>s cause a sign to lock onto a baud rate. (This is also called "autobauding".)
<b>B</b>	<SOH>	01H	Start Of Header character
<b>C</b>	Type Code	"f"	"f" (66H) means that this transmission is directed to all 215C signs.
<b>D</b>	Sign Address	"08"	"08" (30H 38H) means all 215C signs with an address of 08H on the network should "listen" to this transmission.
<b>E</b>	<STX>	02H	Start of TeXt character
<b>F</b>	Command Code	"H"	"H" (48H) is the "Read STRING file" Command Code. (See Table 20, "Read STRING file transmission packet format," on page 38.)
<b>G</b>	File Label	"2"	File Label of the STRING file to read
<b>H</b>	<EOT>	04H	End Of Transmission character

7.6.9.3 Response to Read STRING file example

The following would be the response from the previous (Table 58) example:

Table 59: Response to Read STRING file example

Item	Name	Value	Description
<b>A</b>	<NUL>	00H	Twenty <NUL> (00H) characters
<b>B</b>	<SOH>	01H	Start Of Header character
<b>C</b>	Type Code	"0"	"0" (30H) is the Response code
<b>D</b>	Sign Address	"00"	"00" (30H 30H) is sent regardless of the sign's actual address.
<b>E</b>	<STX>	02H	Start of TeXt character
<b>F</b>	Command Code	"G"	"G" (47H) is returned by the sign
<b>G</b>	File Label	"2"	"2" (32H) is the File Label of the STRING file accessed
<b>H</b>	STRING File Data	"8,234,000"	The actual data in the STRING file
<b>I</b>	<ETX>	03H	End of TeXt character
<b>J</b>	Checksum	"0237"	Four ASCII digits that represent a 16-bit hexadecimal summation of all transmitted data from the previous <STX> through the previous <ETX> inclusive. The most significant digit is first.
<b>K</b>	<EOT>	04H	End Of Transmission character

### 7.6.10 DOTS PICTURE file examples

#### 7.6.10.1 Write DOTS PICTURE file example

The following would write a DOTS PICTURE file labeled "A", 15 pixel rows high x 9 pixel columns wide to a 4160C sign:

**Table 60: Write DOTS PICTURE file example**

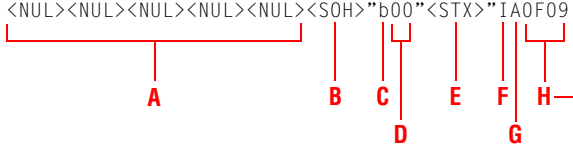

Though this graphic (an arrow) is one contiguous string of data, for the sake of clarity it's broken down into individual rows.

```

"00000000"<CR>
"00000000"<CR>
"00010000"<CR>
"00011000"<CR>
"00011100"<CR>
"00011110"<CR>
"11111110"<CR>
"11111112"<CR>
"11111110"<CR>
"00011110"<CR>
"00011100"<CR>
"00011000"<CR>
"00010000"<CR>
"00000000"<CR>
"00000000"<CR>
<EOT>
    
```

Item	Name	Value	Description		
<b>A</b>	<NUL>	00H	These five <NUL>s cause a sign to lock onto a baud rate. (This is also called "autobauding".)		
<b>B</b>	<SOH>	01H	Start Of Header character		
<b>C</b>	Type Code	"b"	"b" (62H) means that this transmission is directed to all 4160C signs.		
<b>D</b>	Sign Address	"00"	"00" (30H 30H) means all 4160C signs on the network should "listen" to this transmission.		
<b>E</b>	<STX>	02H	Start of TeXt character		
<b>F</b>	Command Code	"I"	"I" (49H) is the "Write SMALL DOTS PICTURE file" Command Code. (See Table 22, "Write SMALL DOTS PICTURE file transmission packet format," on page 39.)		
<b>G</b>	File Label	"A"	File Label of the DOTS file		
<b>H</b>	Data Field	DOTS PICTURE File Data	Height (y)	"0F"	"0F" (30H 46H) = pixel height of graphic = 15D
			Width (x)	"09"	"09" (30H 39H) = pixel width of graphic = 9D
			Row Bit Pattern	"00000000"<CR> "00000000"<CR> "00010000"<CR> "00011000"<CR> "00011100"<CR> "11111110"<CR> "11111112"<CR> "11111110"<CR> "00011110"<CR> "00011100"<CR> "00011000"<CR> "00010000"<CR> "00000000"<CR> "00000000"<CR>	Each row of the graphic is followed by a <CR> (0DH). "0" (30H) = sign pixel off "1" (31H) = sign pixel on - red "2" (32H) = sign pixel on - green
<b>I</b>	<EOT>	04H	End Of Transmission character		

### 7.6.11 Displaying text at XY position examples

Text messages up to 250 characters can be displayed in a particular location on AlphaVision character matrix sign. This can be done by specifying a character position in a sign line (X) and a line position (Y) using the SPECIAL FUNCTION “+” command (see page 22).

The following examples will show how to:

- enable XY positioning
- display text at an XY location
- display multiple text at XY locations
- disable XY positioning

#### 7.6.11.1 Enable SPECIAL FUNCTION XY positioning example

**Table 61: Enable SPECIAL FUNCTION XY positioning example**

Item	Name	Value	Description
<b>A</b>	<NUL>	00H	These five <NUL>s cause a sign to lock onto a baud rate. (This is also called “autobauding”.)
<b>B</b>	<SOH>	01H	Start Of Header character
<b>C</b>	Type Code	“Z”	“Z” (5AH) means that this transmission is directed to all signs.
<b>D</b>	Sign Address	“00”	“00” (30H 30H) means all signs on the network should “listen” to this transmission.
<b>E</b>	<STX>	02H	Start of TeXt character
<b>F</b>	Command Code	“E”	“E” (45H) is the “Write SPECIAL FUNCTION example” on page 69.
<b>G</b>	Data Field	“+”	“+” (2BH) Enable XY positioning
<b>H</b>	<EOT>	04H	End Of Transmission character

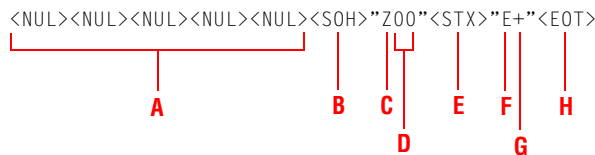

**7.6.11.2 Display text at an XY location example**

The following example shows how to display text in a specified location on an imaginary 4-line x 20-character AlphaVision character matrix sign.

The text “Hello world!” will be displayed starting at character position 14 (X) on line 2 (Y) as shown in the illustration below.

NOTE: Counting starts from 0, not 1, for both the X and the Y location.

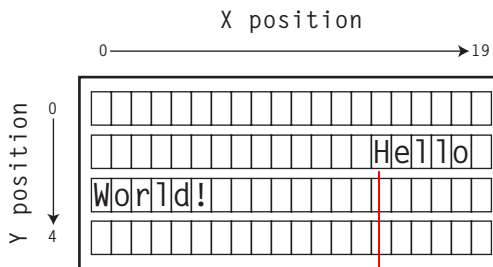

The text starts at the specified XY position (14, 2). Notice that because it doesn't fit on the line, the text wraps onto the next line.

**Table 62: Display text at an XY location example**

Item	Name	Value	Description
<code>&lt;NUL&gt;&lt;NUL&gt;&lt;NUL&gt;&lt;NUL&gt;&lt;NUL&gt;&lt;SOH&gt;"Z00"&lt;STX&gt;"E++1402Hello world!"&lt;EOT&gt;</code>			
		<span style="color: red;">A</span> <span style="color: red;">B</span> <span style="color: red;">C</span> <span style="color: red;">D</span> <span style="color: red;">E</span> <span style="color: red;">F</span> <span style="color: red;">G</span> <span style="color: red;">H</span> <span style="color: red;">I</span> <span style="color: red;">J</span> <span style="color: red;">K</span> <span style="color: red;">L</span>	
<span style="color: red;">A</span>	<NUL>	00H	These five <NUL>s cause a sign to lock onto a baud rate. (This is also called "autobauding".)
<span style="color: red;">B</span>	<SOH>	01H	Start Of Header character
<span style="color: red;">C</span>	Type Code	"Z"	"Z" (5AH) means that this transmission is directed to all signs.
<span style="color: red;">D</span>	Sign Address	"00"	"00" (30H 30H) means all signs on the network should "listen" to this transmission.
<span style="color: red;">E</span>	<STX>	02H	Start of TeXt character
<span style="color: red;">F</span>	Command Code	"E"	"E" (45H) is the "Write SPECIAL FUNCTION example" on page 69.
<span style="color: red;">G</span>	Special Functions Label	"+"	"+" (2BH) Enable XY positioning
<span style="color: red;">H</span>	File Label	"+"	File Label
<span style="color: red;">I</span>	X position	"14"	"14" (31H 34H) Two ASCII decimal digits that represent the character position
<span style="color: red;">J</span>	Y position	"02"	"02" (30H 32H) Two ASCII decimal digits that represent the line position
<span style="color: red;">K</span>	Message Text	"Hello world!"	ASCII message text (up to 250 characters)
<span style="color: red;">L</span>	<EOT>	04H	End Of Transmission character

**7.6.11.3 Display multiple text at XY locations example**

The following example shows how to display three text messages at 3 different locations:

"Hello world!" starts at  $X_1 = 4, Y_1 = 0$ .  
 "This is a test" starts at  $X_2 = 0, Y_2 = 3$ .  
 "The end" starts at  $X_3 = 13, Y_3 = 4$ .

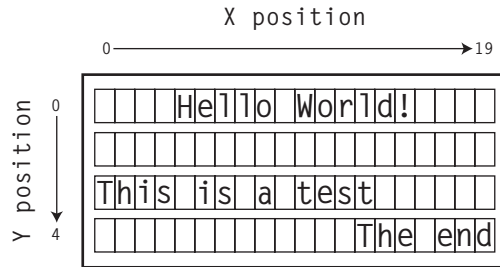

**Table 63: Display multiple text at XY locations example**

<code>&lt;NUL&gt;&lt;NUL&gt;&lt;NUL&gt;&lt;NUL&gt;&lt;NUL&gt;&lt;SOH&gt;"Z00"&lt;STX&gt;"E++0400Hello world!"&lt;DC2&gt;"0003This is a test"&lt;DC2&gt;"1304The end"&lt;EOT&gt;</code>			
Item	Name	Value	Description
A	<NUL>	00H	These five <NUL>s cause a sign to lock onto a baud rate. (This is also called "autobauding".)
B	<SOH>	01H	Start Of Header character
C	Type Code	"Z"	"Z" (5AH) means that this transmission is directed to all signs.
D	Sign Address	"00"	"00" (30H 30H) means all signs on the network should "listen" to this transmission.
E	<STX>	02H	Start of TeXt character
F	Command Code	"E"	"E" (45H) is the "Write SPECIAL FUNCTION example" on page 69.
G	Special Functions Label	"+"	"+" (2BH) Enable XY positioning
H	File Label	"0"	File Label
I	$X_1$ position	"04"	"04" (30H 34H) Two ASCII decimal digits that represent the character position of the first text message
J	$Y_1$ position	"00"	"00" (30H 30H) Two ASCII decimal digits that represent the line position of the first text message
K	Message Text 1	"Hello world!"	First ASCII message text (up to 250 characters)
L	<DC2>	12H	Device Control 2 character which signals another XY position
M	$X_2$ position	"00"	"00" (30H 30H) Two ASCII decimal digits that represent the character position of the second text message
N	$Y_2$ position	"03"	"03" (30H 33H) Two ASCII decimal digits that represent the line position of the second text message
O	Message Text 2	"This is a test"	Second ASCII message text (up to 250 characters)
P	<DC2>	12H	Device Control 2 character which signals another XY position
Q	$X_3$ position	"13"	"13" (31H 33H) Two ASCII decimal digits that represent the character position of the third text message
R	$Y_3$ position	"04"	"04" (30H 34H) Two ASCII decimal digits that represent the line position of the third text message
S	Message Text 3	"The end"	Third ASCII message text (up to 250 characters)
T	<EOT>	04H	End Of Transmission character

## 7.6.11.4 Disable SPECIAL FUNCTION XY positioning example

Table 64: Disable SPECIAL FUNCTION XY positioning example

Item	Name	Value	Description
<b>A</b>	<NUL>	00H	These five <NUL>s cause a sign to lock onto a baud rate. (This is also called "autobauding".)
<b>B</b>	<SOH>	01H	Start Of Header character
<b>C</b>	Type Code	"Z"	"Z" (5AH) means that this transmission is directed to all signs.
<b>D</b>	Sign Address	"00"	"00" (30H 30H) means all signs on the network should "listen" to this transmission.
<b>E</b>	<STX>	02H	Start of TeXt character
<b>F</b>	Command Code	"E"	"E" (45H) is the "Write SPECIAL FUNCTION example" on page 69.
<b>G</b>	Data Field	"-"	"-" (2DH) Disable XY positioning
<b>H</b>	<EOT>	04H	End Of Transmission character

NOTE: An "E\$" command will clear the display in XY mode.



## 7.7 Appendix G: Alpha protocol ASCII table

### 7.7.1 Standard character set (00 – 7FH)

#### 7.7.1.1 Control codes (00 – 1FH)

	Dec	Hex	Character	Meaning
Control codes	0	00	^@	NUL
	1	01	^A	SOH
	2	02	^B	STX
	3	03	^C	ETX
	4	04	^D	EOT
	5	05	^E	Double high characters (2-byte format) <ul style="list-style-type: none"> <li>• 05H + "0" (30H) = Double height off (default)</li> <li>• 05H + "1" (31H) = Double height on</li> </ul>
	6	06	^F	True descenders (2-byte format) <ul style="list-style-type: none"> <li>• 06H + "0" (30H) = True descenders off (default)</li> <li>• 06H + "1" (31H) = True descenders on</li> </ul>
	7	07	^G	Character flash (2-byte format) <ul style="list-style-type: none"> <li>• 07H + "0" (30H) = Character flash off (default)</li> <li>• 07H + "1" (31H) = Character flash on</li> </ul>
	8	08	^H	Extended character sets (2-byte format) <ul style="list-style-type: none"> <li>• 08H + Offset (20H through 61H) (see the following "Extended character set")</li> </ul> Display temperature (2-byte format): <ul style="list-style-type: none"> <li>• 08H + "^\" (1CH) = display temperature in Celsius (only on Solar, 790i, 460i, 440i, and 430i)</li> <li>• 08H + "^]" (1DH) = display temperature in Fahrenheit (only on Solar, 790i, 460i, 440i, and 430i)</li> </ul>
	9	09	^I	No Hold speed — when used, there will be virtually no pause following the mode presentation. This is not applicable for the Rotate or Compressed Rotate modes.
	10	0A	^J	
	11	0B	^K	Call date (2-byte format) — the date will be displayed, where DD = date, MM = month, YY = year, MMM = month abbreviation, and YYYY = year: <ul style="list-style-type: none"> <li>• 0BH + "0" (30H) = MM/DD/YY</li> <li>• 0BH + "1" (31H) = DD/MM/YY</li> <li>• 0BH + "2" (32H) = MM-DD-YY</li> <li>• 0BH + "3" (33H) = DD-MM-YY</li> <li>• 0BH + "4" (34H) = MM.DD.YY</li> <li>• 0BH + "5" (35H) = DD.MM.YY</li> <li>• 0BH + "6" (36H) = MM DD YY</li> <li>• 0BH + "7" (37H) = DD MM YY</li> <li>• 0BH + "8" (38H) = MMM.DD, YYYY</li> <li>• 0BH + "9" (39H) = Day of week</li> </ul>
	12	0C	^L	New page — start of next display page
	13	0D	^M	New line — start of new line
	14	0E	^N	
	15	0F	^O	Speed control — see "Speed control" on page 107. (Alpha 2.0 protocol only)
	16	10	^P	Call STRING file (2-byte format) — must be followed by a STRING File Label.
	17	11	^Q	Disable wide characters
	18	12	^R	Enable wide characters
	19	13	^S	Call Time — time of day will be called up.
	20	14	^T	Call SMALL DOTS PICTURE file (2-byte format) — must be followed by a DOTS PICTURE File Label.
	21	15	^U	Speed 1 (slowest)
	22	16	^V	Speed 2
	23	17	^W	Speed 3
	24	18	^X	Speed 4
25	19	^Y	Speed 5 (fastest)	



7.7.1.2 Standard ASCII characters (20 – 7FH)

	Dec	Hex	Character
<b>Standard ASCII characters</b>	32	20	space
	33	21	!
	34	22	"
	35	23	#
	36	24	\$
	37	25	%
	38	26	&
	39	27	'
	40	28	(
	41	29	)
	42	2A	*
	43	2B	+
	44	2C	,
	45	2D	-
	46	2E	.
	47	2F	/
	48	30	0
	49	31	1
	50	32	2
	51	33	3
	52	34	4
	53	35	5
	54	36	6
	55	37	7
	56	38	8
	57	39	9
	58	3A	:
	59	3B	;
	60	3C	<
61	3D	=	
62	3E	>	
63	3F	?	
64	40	@	
65	41	A	
66	42	B	
67	43	C	
68	44	D	
69	45	E	
70	46	F	
71	47	G	
72	48	H	
73	49	I	
74	4A	J	
75	4B	K	
76	4C	L	
77	4D	M	
78	4E	N	
79	4F	O	

Dec	Hex	Character
80	50	P
81	51	Q
82	52	R
83	53	S
84	54	T
85	55	U
86	56	V
87	57	W
88	58	X
89	59	Y
90	5A	Z
91	5B	[
92	5C	\
93	5D	]
94	5E	¢
95	5F	_
96	60	'
97	61	a
98	62	b
99	63	c
100	64	d
101	65	e
102	66	f
103	67	g
104	68	h
105	69	i
106	6A	j
107	6B	k
107	6C	l
109	6D	m
110	6E	n
111	6F	o
112	70	p
113	71	q
114	72	r
115	73	s
116	74	t
117	75	u
118	76	v
119	77	w
120	78	x
121	79	y
122	7A	z
123	7B	{
124	7C	
125	7D	}
126	7E	1/2 space
127	7F	block

### 7.7.2 Extended character set (80 - C1H)

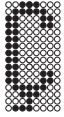
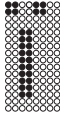
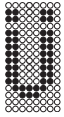
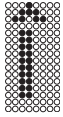
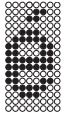
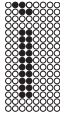
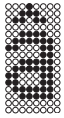
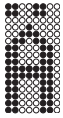
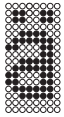
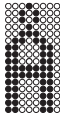
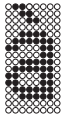
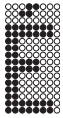
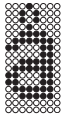
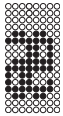
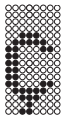
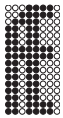
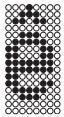
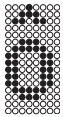
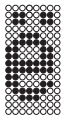
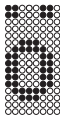
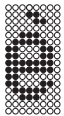
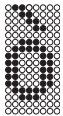

The following characters can be displayed by combining a control code (^H) with an offset (as shown below).

NOTE: This character set is not available with the 5-high character set.

	Dec	Hex	Character	Control code combination		Dec	Hex	Character	Control code combination
Extended character set	128	80		08H + 20H	139	8B		08H + 2BH	
	129	81		08H + 21H	140	8C		08H + 2CH	
	130	82		08H + 22H	141	8D		08H + 2DH	
	131	83		08H + 23H	142	8E		08H + 2EH	
	132	84		08H + 24H	143	8F		08H + 2FH	
	133	85		08H + 25H	144	90		08H + 30H	
	134	86		08H + 26H	145	91		08H + 31H	
	135	87		08H + 27H	146	92		08H + 32H	
	136	88		08H + 28H	147	93		08H + 33H	
	137	89		08H + 29H	148	94		08H + 34H	
138	8A		08H + 2AH	149	95		08H + 35H		

	Dec	Hex	Character	Control code combination
Extended character set (cont)	150	96		08H + 36H
	151	97		08H + 37H
	152	98		08H + 38H
	153	99		08H + 39H
	154	9A		08H + 3AH
	155	9B		08H + 3BH
	156	9C		y08H + 3CH
	157	9D		08H + 3DH
	158	9E		08H + 3EH
	159	9F		08H + 3FH
	160	A0		08H + 40H
	161	A1		08H + 41H

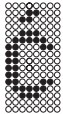
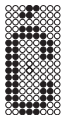
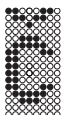
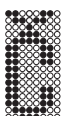
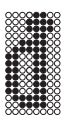
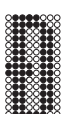
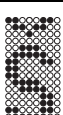
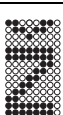
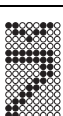
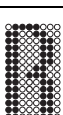
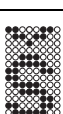
Dec	Hex	Character	Control code combination
162	A2		08H + 42H
163	A3		08H + 43H
164	A4		08H + 44H
165	A5		08H + 45H
166	A6		08H + 46H
167	A7		08H + 47H
168	A8		08H + 48H
169	A9		08H + 49H
170	AA		08H + 4AH
171	AB		08H + 4BH
172	AC		08H + 4CH
173	AD		08H + 4DH

	Dec	Hex	Character	Control code combination
Extended character set (cont)	174	AE		08H + 4EH
	175	AF		08H + 4FH
	176	B0		08H + 50H
	177	B1		08H + 51H
	178	B2		08H + 52H
	179	B3		08H + 53H
	180	B4		08H + 54H
	181	B5		08H + 55H
	182	B6		08H + 56H
	183	B7		08H + 57H
	184	B8		08H + 58H
	185	B9		08H + 59H

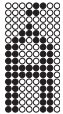
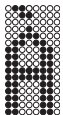
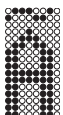
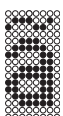
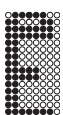
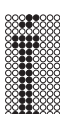
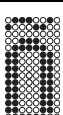
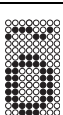
Dec	Hex	Character	Control code combination
186	BA		08H + 5AH
187	BB		08H + 5BH
188	BC		08H + 5CH
189	BD		08H + 5DH
190	BE		08H + 5EH
191	BF		08H + 5FH
192	C0		08H + 60H
193	C1		08H + 61H
194	C2	EURO symbol	08H + 62H
195	C3	Y punctuation key	08H + 63H <sup>1</sup>
196	C4	Up arrow	08H + 64H <sup>1</sup>
197	C5	Down arrow	08H + 65H <sup>1</sup>

	Dec	Hex	Character	Control code combination		Dec	Hex	Character	Control code combination
<b>Extended character set (cont)</b>	198	C6	Left arrow	08H + 66H <sup>1</sup>					
	199	C7	Right arrow	08H + 67H <sup>1</sup>					
	200	C8	Packman	08H + 68H <sup>1</sup>					
	201	C9	Sail boat	08H + 69H <sup>1</sup>					
	202	CA	Ball	08H + 6AH <sup>1</sup>					
	203	CB	Telephone	08H + 6BH <sup>1</sup>					
	204	CC	Heart	08H + 6CH <sup>1</sup>					
	205	CD	Car	08H + 6DH <sup>1</sup>					
	206	CE	Handicap	08H + 6EH <sup>1</sup>					
	207	CF	Rhino	08H + 6FH <sup>1</sup>					
<b>Special commands</b>	208	D0	Mug	08H + 70H <sup>1</sup>					
	209	D1	Satellite dish	08H + 71H <sup>1</sup>					
	210	D2	Copyright symbol	08H + 72H <sup>1</sup>					
	211	D3	Male symbol	08H + 73H <sup>1</sup>					
	212	D4	Female symbol	08H + 74H <sup>1</sup>					
	213	D5	Bottle	08H + 75H <sup>1</sup>					
	214	D6	Diskette	08H + 76H <sup>1</sup>					
	215	D7	Printer	08H + 77H <sup>1</sup>					
	216	D8	Musical note	08H + 78H <sup>1</sup>					
	217	D9	Infinity symbol	08H + 79H <sup>1</sup>					
			Temperature	08H + “^” (1CH) <sup>2</sup>					
				08H + “^” (1DH) <sup>2</sup>					
			Counters	08H + “z” (7AH) Displays the current value in Counter 1.					
				08H + “{” (7BH) Displays the current value in Counter 2.					
				08H + “ ” (7CH) Displays the current value in Counter 3.					
		08H + “}” (7DH) Displays the current value in Counter 4.							
		08H + “~” (7EH) Displays the current value in Counter 5.							
NOTES:									
<sup>1</sup> Only applies to Betabrite 1036, AlphaPremiere 9000, and AlphaEclipse signs. <sup>2</sup> Displays temperature in Celsius (only on Solar, 790i, 460i, 440i, 430i, and AlphaEclipse signs).									

## 7.8 Appendix H: ISO ASCII table

This is the standard ASCII character set:

Character			Hex	Dec	Character			Hex	Dec		
Control characters	NUL	^@	null	00	0	Uppercase letters	@	40	64		
	SOH	^A	start of heading	01	1		A	41	65		
	STX	^B	start of text	02	2		B	42	66		
	ETX	^C	end of text	03	3		C	43	67		
	EOT	^D	end of transmission	04	4		D	44	68		
	ENQ	^E	enquiry	05	5		E	45	69		
	ACK	^F	acknowledge	06	6		F	46	70		
	BEL	^G	bell	07	7		G	47	71		
	BS	^H	backspace	08	8		H	48	72		
	HT	^I	horizontal tab	09	9		I	49	73		
	LF, NL	^J	line feed, new line	0A	10		J	4A	74		
	VT	^K	vertical tab	0B	11		K	4B	75		
	FF, NP	^L	form feed, new page	0C	12		L	4C	76		
	CR	^M	carriage return	0D	13		M	4D	77		
	SO	^N	shift out	0E	14		N	4E	78		
	SI	^O	shift in	0F	15		O	4F	79		
	DLE	^P	data link escape	10	16		P	50	80		
	DC1	^Q	device control 1	11	17		Q	51	81		
	DC2	^R	device control 2	12	18		R	52	82		
	DC3	^S	device control 3	13	19		S	53	83		
	DC4	^T	device control 4	14	20		T	54	84		
	NAK	^U	negative acknowledge	15	21		U	55	85		
	SYN	^V	synchronous idle	16	22		V	56	86		
	ETB	^W	end of transmission block	17	23		W	57	87		
	CAN	^X	cancel	18	24		X	58	88		
	EM	^Y	end of medium	19	25		Y	59	89		
	SUB	^Z	substitute	1A	26		Z	5A	90		
	ESC	^[	escape	1B	27		[	5B	91		
	FS	^\ ^_	file separator	1C	28		\	5C	92		
	GS	^]	group separator	1D	29		]	5D	93		
	RS	^^	record separator	1E	30		^	5E	94		
	US	^_	unit separator	1F	31		_	5F	95		
	Special characters and numbers			space	20		32			60	96
			!		21		33	a	61	97	
		"		22	34	b	62	98			
		#		23	35	c	63	99			
		\$		24	36	d	64	100			
		%		25	37	e	65	101			
		&		26	38	f	66	102			
		'		27	39	g	67	103			
		(		28	40	h	68	104			
		)		29	41	i	69	105			
		*		2A	42	j	6A	106			
		+		2B	43	k	6B	107			
		,		2C	44	l	6C	108			
		-		2D	45	m	6D	109			
		.		2E	46	n	6E	110			
		/		2F	47	o	6F	111			
		0		30	48	p	70	112			
		1		31	49	q	71	113			
		2		32	50	r	72	114			
		3		33	51	s	73	115			
		4		34	52	t	74	116			
		5		35	53	u	75	117			
		6		36	54	v	76	118			
		7		37	55	w	77	119			
		8		38	56	x	78	120			
		9		39	57	y	79	121			
		:		3A	58	z	7A	122			
		;		3B	59	{	7B	123			
		<		3C	60		7C	124			
		=		3D	61	}	7D	125			
		>		3E	62	~	7E	126			
		?		3F	63	DEL	7F	127			



## 7.9 Appendix I: Modes, fonts, colors, and display options available on signs

Modes are ways of displaying information on a sign. For example, the ROTATE Mode makes text or graphics travel from right to left on a sign.

### 7.9.1 Standard Modes

When a Standard Mode Code of “n” (6EH) is given (see **Table 65**), the following Special Modes (**Table 66**) or Special Graphics (**Table 67**) can be designated in the Special Specifier field (see “TEXT file commands” on page 17).

**Table 65: Standard Modes**

Mode name	ASCII code	Hex code	Description
ROTATE	“a”	61H	Message travels right to left.
HOLD	“b”	62H	Message remains stationary.
FLASH	“c”	63H	Message remains stationary and flashes.
reserved	“d”	64H	
ROLL UP	“e”	65H	Previous message is pushed up by a new message.
ROLL DOWN	“f”	66H	Previous message is pushed down by a new message.
ROLL LEFT	“g”	67H	Previous message is pushed left by a new message.
ROLL RIGHT	“h”	68H	Previous message is pushed right by a new message.
WIPE UP	“i”	69H	New message is wiped over the previous message from bottom to top.
WIPE DOWN	“j”	6AH	New message is wiped over the previous message from top to bottom.
WIPE LEFT	“k”	6BH	New message is wiped over the previous message from right to left.
WIPE RIGHT	“l”	6CH	New message is wiped over the previous message from left to right.
SCROLL	“m”	6DH	New message line pushes the bottom line to the top line if 2-line sign.
AUTOMODE	“o”	6FH	Various Modes are called upon to display the message automatically.
ROLL IN	“p”	70H	Previous message is pushed toward the center of the display by the new message.
ROLL OUT	“q”	71H	Previous message is pushed outward from the center by the new message.
WIPE IN	“r”	72H	New message is wiped over the previous message in an inward motion.
WIPE OUT	“s”	73H	New message is wiped over the previous message in an outward motion.
COMPRESSED ROTATE	“t”	74H	Message travels right to left. Characters are approximately one half their normal width. (Only available on certain sign models.)
EXPLODE	“u”	75H	Message flies apart from the center (Alpha 3.0 protocol).
CLOCK	“v”	76H	Wipe in a clockwise direction (Alpha 3.0 protocol).
SPECIAL	“n”	6EH	This is followed by a Special Specifier ASCII character which defines one of the Special Modes. See “Special Modes” on page 89.

### 7.9.2 Special Modes

**Table 66: Special Modes**

Mode name	ASCII code	Hex code	Description (animations do NOT work on Alpha 3.0 protocol signs)	Will Mode appear on this length AlphaEclipse?	
				64 column	> 80 columns
TWINKLE	“0”	30H	Message will twinkle on the sign.	Yes	Yes
SPARKLE	“1”	31H	New message will sparkle over the current message.	Yes	Yes
SNOW	“2”	32H	Message will “snow” onto the display.	Yes	Yes
INTERLOCK	“3”	33H	New message will interlock over the current message in alternating rows of dots from each end.	Yes	Yes
SWITCH	“4”	34H	Alternating characters “switch” off the sign up and down. New message “switches” on in a similar manner.	Yes	Yes

**Table 66: Special Modes**

Mode name	ASCII code	Hex code	Description (animations do NOT work on Alpha 3.0 protocol signs)	Will Mode appear on this length AlphaEclipse?	
				64 column	> 80 columns
SLIDE or CYCLE COLORS <sup>1</sup>	"5"	35H	New message slides onto the sign one character at a time from right to left.	Yes <sup>2</sup>	Yes <sup>2</sup>
SPRAY	"6"	36H	New message sprays across and onto the sign from right to left.	Yes	Yes
STARBURST	"7"	37H	"Starbursts" explode the new message onto the sign (animation).	Yes	Yes
WELCOME	"8"	38H	The word "Welcome" is written in script across the sign (animation).	No	Yes
SLOT MACHINE	"9"	39H	Slot machine symbols appear randomly across the sign (animation).	No	Yes
NEWS FLASH <sup>1</sup>	"A"	3AH	News flash animation	—	—
TRUMPET ANIMATION <sup>1</sup>	"B"	3BH	Trumpet animation	—	—
CYCLE COLORS	"C"	43H	Color changes from one color to another.	Yes <sup>3</sup>	Yes <sup>3</sup>

<sup>1</sup> only available on Betabrite model 1036 signs  
<sup>2</sup> SLIDE will appear, but COLOR CYCLE will only work on AlphaEclipse 3600 signs  
<sup>3</sup> COLOR CYCLE will only work on AlphaEclipse 3600 signs

**7.9.3 Special Graphics****Table 67: Special Graphics**

Mode name	ASCII code	Hex code	Description (animations do NOT work on Alpha 3.0 protocol signs)	Will Mode appear on this length AlphaEclipse?	
				64 columns	> 80 columns
THANK YOU	"S"	53H	The words "Thank You" are written in script across the sign (animation).	No	Yes
NO SMOKING	"U"	55H	A cigarette image appears, is then extinguished and replaced with a no smoking symbol (animation).	No	Yes
DON'T DRINK & DRIVE	"V"	56H	A car runs into a cocktail glass and is replaced with the text "Please don't drink and drive" (animation)	No	Yes
RUNNING ANIMAL or FISH ANIMATION <sup>1</sup>	"W"	57H	An animal runs across the sign (animation).	Yes <sup>2</sup>	Yes <sup>2</sup>
FIREWORKS	"X"	58H	Fireworks explode randomly across the sign (animation).	Yes	Yes
TURBO CAR or BALLOON ANIMATION <sup>1</sup>	"Y"	59H	A car drives across the sign (animation).	Yes	Yes
CHERRY BOMB	"Z"	5AH	A bomb fuse burns down followed by an explosion (animation).	Yes	Yes

<sup>1</sup> only available on Betabrite model 1036 signs  
<sup>2</sup> FISH ANIMATION is only available on Betabrite model 1036 signs



7.9.5 Fonts and colors available on signs

Table 69: Fonts and colors available on signs

Signs	Characters													
	15/16 Row Normal	15/16 Row Fancy	Ten Row	Seven Row Normal	Seven Row Fancy	Five Row	Color <sup>1</sup>	Normal	Wide	Double Wide	Flashing	Double Height	True Descenders	Fixed Width
200 Series <sup>2</sup> :				●	●	●	●	●	●	●				●
220C:				●	●	●	●	●	●	●	●			●
300 Series <sup>3</sup> :				●	●	●	●	●	●	●	●			●
420C:				●	●	●	●	●	●	●	●			●
430i:				●		●		●	●	●				●
440i:				●		●		●	●	●				●
460i:				●		●		●	●	●				●
790i:				●		●		●	●	●				●
4000 Series <sup>4</sup> :	●	●		●	●	●	●	●	●	●	●			●
7000 Series <sup>5</sup> :	●	●	●	●	●	●	●	●	●	●	●	●	●	●
AlphaEclipse 1500 Time & Temp <sup>6</sup> :														
AlphaEclipse 2500:	●	●	●	●	●	●		●	●	●	●	●	●	●
AlphaEclipse 2600:	●	●	●	●	●	●		●	●	●	●	●	●	●
AlphaEclipse 3500:	●	●	●	●	●	●		●	●	●	●	●	●	●
AlphaEclipse 3600 <sup>7</sup> :	●	●	●	●	●	●	●	●	●	●	●	●	●	●
AlphaEclipse RoadStar	●	●	●	●	●	●	● <sup>8</sup>	●	●	●	●	●	●	●
AlphaEclipse StreetSmart	●	●	●	●	●	●	● <sup>8</sup>	●	●	●	●	●	●	●
AlphaPremiere:	●	●	●	●	●	●	●	●	●	●	●	●	●	●
AlphaVision (full matrix):	●	●	●	●	●	●	●	●	●	●	●	●	●	●
AlphaVision (character matrix):				●		●	●	●			●			
BetaBrite:				●	●	●	●	●	●	●	●			●
Big Dot:				●	●	●	●	●	●	●	●			●
Director:				●		●	●	●			●			
PPD:				●	●	●		●	●	●	●			●
Serial LED clock <sup>6</sup> :														
Solar:	●	●		●	●	●	●	●	●	●	●			●

<sup>1</sup> Sign models ending in "C", such as 4120C, have color capabilities. Sign names ending in "R", such as 4120R, can display in red only.  
<sup>2</sup> This includes the 215R and 215C model signs ("C" = tricolor LEDs, "R" = red LEDs).  
<sup>3</sup> This includes the 320C and 330C model signs ("C" = tricolor LEDs, "R" = red LEDs).  
<sup>4</sup> This includes the 4080C, 4120C, 4120R, 4160C, 4160R, 4200C, 4200R, 4240C, and 4240R model signs ("C" = tricolor LEDs, "R" = red LEDs).  
<sup>5</sup> This includes the 7080C, 7120C, 7160C, and 7200C model signs ("C" = tricolor LEDs, "R" = red LEDs).  
<sup>6</sup> This sign can only display time updates from messaging software. This sign cannot display text messages or graphics.  
<sup>7</sup> This sign has RGB (red, green, and blue) LEDs that are capable of displaying over 16 million colors.  
<sup>8</sup> RoadStar and StreetSmart signs cannot display color; however, these signs can display up to 256 shades and greyscale shades.

7.9.6 Display options available on signs

Table 70: Display options available on signs

Signs	Options															
	Time	Date	Temperature		Speed	New Line	New Page	Animation	String	Trucker Symbol	Variable	Counter	Graphic <sup>1</sup>	Gif <sup>1</sup>	Flick <sup>1</sup>	Message
			Fahrenheit	Celsius												
200 Series <sup>2</sup> :	●	●			●	●		●	●	●	●	●	●			●
220C:	●	●			●	●		●	●	●	●	●	●			●
300 Series <sup>3</sup> :	●	●			●	●		●	●	●	●	●	●			●
420C:	●	●			●	●		●	●	●	●	●	●			●
430i:	●		●	●	●	●		●	●	●	●	●	●			●
440i:	●		●	●	●	●		●	●	●	●	●	●			●
460i:	●		●	●	●	●		●	●	●	●	●	●			●
790i:	●		●	●	●	●		●	●	●	●	●	●			●
4000 Series <sup>4</sup> :	●	●			●	●		●	●	●	●	●	●			●
7000 Series <sup>5</sup> :	●	●			●	●	●		●	●	●	●	●	●	●	●
AlphaEclipse 1500 Time & Temp <sup>6</sup> :																
AlphaEclipse 2500:	●	●	●	●	●	●	●	●	●	●	●	●	●	●	●	●
AlphaEclipse 2600:	●	●	●	●	●	●	●	●	●	●	●	●	●	●	●	●
AlphaEclipse 3500:	●	●	●	●	●	●	●	●	●	●	●	●	●	●	●	●
AlphaEclipse 3600 <sup>7</sup> :	●	●	●	●	●	●	●		●	●	●	●	●	●	●	●
AlphaEclipse RoadStar	●	●	●	●	●	●	●		●	●	●	●	●	●	●	●
AlphaEclipse StreetSmart	●	●	●	●	●	●	●		●	●	●	●	●	●	●	●
AlphaPremiere:	●	●			●	●	●	●	●	●	●	●	●	●	●	●
AlphaVision (full matrix):	●	●			●	●	●		●	●	●	●	●	●	●	●
AlphaVision (character matrix):	●	●			●	●	●		●	●	●	●				●
Big Dot:	●	●			●	●		●	●	●	●	●				●
BetaBrite:	●	● <sup>8</sup>			●	●		●	●	●	●		●			●
Director:	●	●			●	●		●	●	●	●					●
PPD:	●	●			●	●		●	●	●	●		●			●
Serial LED clock <sup>6</sup> :																
Solar:	●	●	●	●	●	●		●	●	●	●	●	●			●

<sup>1</sup> A graphic, gif, or flick must be designed for the resolution of the sign. For example, a 4120C sign has a resolution of 120 columns by 16 rows. Therefore, in order to fit on a 4120C, an image can be no greater than 120 x 16 pixels in size.  
<sup>2</sup> This includes the 215R and 215C model signs ("C" = tricolor LEDs, "R" = red LEDs).  
<sup>3</sup> This includes the 320C and 330C model signs ("C" = tricolor LEDs, "R" = red LEDs).  
<sup>4</sup> This includes the 4080C, 4120C, 4120R, 4160C, 4160R, 4200C, 4200R, 4240C, and 4240R model signs ("C" = tricolor LEDs, "R" = red LEDs).  
<sup>5</sup> This includes the 7080C, 7120C, 7160C, and 7200C model signs ("C" = tricolor LEDs, "R" = red LEDs).  
<sup>6</sup> This sign can only display time updates from messaging software. This sign cannot display text messages or graphics.  
<sup>7</sup> This sign has RGB (red, green, and blue) LEDs that are capable of displaying over 16 million colors.  
<sup>8</sup> Even though the date can be displayed on a BetaBrite sign, the date is NOT real-time and, therefore, will not change.

## 7.10 Appendix J: Position rules for signs

Position rules deal with *where* text will appear on a sign.

### 7.10.1 Sign classes

- One-line signs — like the Betabrite, 220C, and 300 series are of varying lengths, but are always 7 dots (or pixels) high.
- Two-line signs — like the 4000 series are of varying lengths, but are always 16 dots high.
- Three-line signs (like the 7000 series) and Multiple-line full matrix signs (like the Director) are of varying lengths and heights.
- Multiple-line character matrix signs — like certain AlphaVision models are of varying lengths and widths.

### 7.10.2 Position classes

- Top
- Bottom
- Left (Alpha 3.0 protocol only)
- Right (Alpha 3.0 protocol only)
- Middle
- Fill

### 7.10.3 Position rule examples

#### 7.10.3.1 One-line sign example

##### RULE:

All characters line up at the bottom of the sign and work their way up for as many dots as the font supports:

**NOTE**  
The screen shots used in these examples are taken from the Emulator program that is part of the AlphaNET sign messaging software.

This is how a message is created in AlphaNET software:

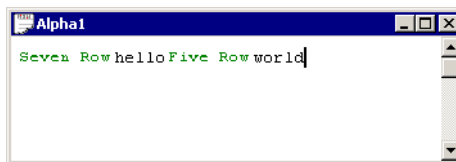

This is how the message would appear on a one-line sign:

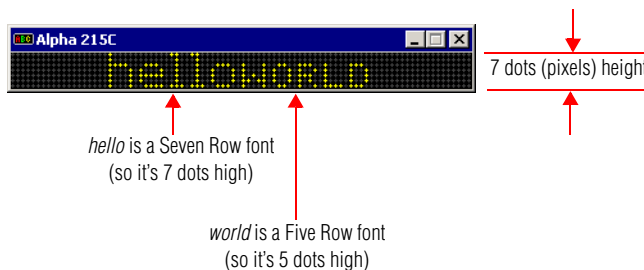

NOTE: The Left and Right position classes work the same way on all sizes of displays running Alpha 3.0 protocol. They are described in “**Left/Right position (Alpha 3.0 protocol only)**” on page 98.

##### EXCEPTION CONDITIONS (one-line signs):

- If a sign receives a font that is larger than the sign can display, then the sign will “size down” or reduce the font size. For example, on a one-line sign, 15 high fancy characters would be replaced by 7 high fancy

characters.

- If a graphic is received that is taller than what a one-line sign can display, then only the top 7 rows will be displayed.
- If a graphic is received that is longer than what a one-line sign can display, then only the leftmost columns will be displayed.
- If a graphic is received that is smaller than 7 dots high, then the graphic will be displayed from the bottom of the sign working up.
- If a character font is not specified, then 7-high normal will be used.
- If Top, Bottom, or Fill positions are received Middle is used.
- The centerline is never placed further left than 8 pixels from the leftmost pixel of the sign.
- The centerline is never placed further right than 8 pixels from the rightmost pixel of the sign.

### 7.10.3.2 Two-line sign example

#### 7.10.3.2.1 Top position

**RULE:**

Defined as the top 7 dots of the sign. The Top position functions in the same manner as a one-line sign (see exception conditions for a one-line sign).

#### 7.10.3.2.2 Bottom position

**RULE:**

Defined as the bottom 7 dots of the sign. The Bottom position functions in the same manner as a one-line sign (see exception conditions for a one-line sign).

#### 7.10.3.2.3 Left/Right position (Alpha 3.0 protocol only)

The Left and Right position classes work the same way on all sizes of displays running Alpha 3.0 protocol. They are described in “**Left/Right position (Alpha 3.0 protocol only)**” on page 98.

#### 7.10.3.2.4 Middle position

**RULE:**

The Middle position is treated as though it was a 1 line sign 16 dots high. Each line of text presented on this line is prescanned to determine the largest piece of text (or graphic) to be displayed. For example, if a line of 5-high text has just a single 10-high character, the line is viewed as a 10-high line. This means that 10-high characters will be displayed with 3 dots above and below the characters (3+10+3 = 16).

**EXCEPTION CONDITIONS:**

- If the sign receives a font that is larger than the sign can display, then the sign will “size down” or reduce the font size. On a two-line sign, the only characters that are too large would be characters using the “double high” control code. In this case, the control code would be ignored.
- If a graphic is received that is taller than what a two-line sign can display, then only the top 16 rows will be displayed.

- If a graphic is received that is longer than what a two-line sign can display, then only the leftmost columns will be displayed.
- If a character font is not specified, then 16-high normal will be used.

#### 7.10.3.2.5 Fill position

##### RULE:

On a two-line sign, the Fill position indicates that you wish to use no more than 7-high characters and that you wish to fit as much text on the screen as you can.

When using the Fill position, the sign sees itself as having two lines of 7-high characters and no means of displaying characters larger than 7-high. If a graphic is selected, then at most 7 rows of that graphic will be displayed. Also, if the last piece of a message is just one line, then the sign will center this line on the screen.

If the sign is operating on the *top* row, then the bottom of that row is assumed to be the 7th row of dots. All text is started from there and worked up: 5-high characters will use rows 3 to 7 and 7-high characters will use rows 1 to 7.

If the sign is operating on the *bottom* row, then the sign works its way up from row 16: 5-high characters will use rows 12 to 16 and 7-high characters will use rows 10 to 16.

##### EXCEPTION CONDITIONS:

- If, when using the Top, Bottom, or Fill position, a sign receives a font that is larger than 7-high, then the sign will “size down” or reduce the font size. For example, 15 high fancy characters would be replaced by 7 high fancy characters.
- If a graphic is received that is taller than 7 rows high (15 high for Middle position), then only the top 7 (top 15 for Middle position) rows will be displayed.
- If a graphic is received that is longer than what a one-line sign can display, then only the leftmost columns will be displayed.
- If a character font is not specified, then 7-high normal will be used.

#### 7.10.3.3 Three-line sign example

##### 7.10.3.3.1 Top/Bottom positions

##### RULE:

The Top and Bottom positions work in tandem with each other. There is an imaginary line between the top and bottom half of the sign. This is called the “centerline”. The centerline divides what is used for the Top from what is used for the Bottom positions (see example next page).





The location of the centerline is usually established by the first Top command the sign receives, and the rest of the space is used for the Bottom position. If a Bottom position command comes first, then the centerline is placed at its highest position — row 8, allowing for a single line of 7-high characters on the Top position.

Once a centerline has been established, it remains fixed until a Fill or Middle position command is received. The centerline can not be changed with another Top or Bottom position command.

However, if the first command specifies a Top, and not a Bottom, position, then the centerline's position is determined by the amount of text following the position command. For example,

- If one 7-high line of text is received (following a Top position command), then the centerline will be fixed at row 8.
- If one line of 10-high characters is received (following a Top position command), then the centerline will be fixed at row 11.
- If two lines of 5-high characters are received (following a Top position command), then the centerline is placed at row 12 (5 rows for each line of text plus a blank row between the lines).

**EXCEPTION CONDITIONS:**

- The centerline is never placed higher than 8 rows from the top of the sign.
- The centerline is never placed lower than 8 rows from the bottom of the sign.

**7.10.3.3.2 Left/Right position** (Alpha 3.0 protocol only)**RULE:**

The Left and Right positions work in tandem with each other, much like the Top and Bottom positions for multi-line signs (see page 96).

An imaginary line (called the “centerline”) divides what is used for the Left from what is used for the Right positions. The location of the centerline is usually established by the first Left command the sign receives, and the rest of the space is used for the Right position.

The placement of this centerline will be determined by a new line. If no new line is given, the text will continue up to the rightmost 8 pixels, which will be reserved for the Right position. If a Right position command comes first, then the centerline is placed at the leftmost position — column 8, allowing for a single character in the Left position.

```
Alpha1
Color Amber
Left Hold
This is theNew Line
LEFT POSITION
Right Hold
This is theNew Line
RIGHT POSITION
```



Centerline



Once a centerline has been established, it remains fixed until a Fill or Middle position has been received.

**EXCEPTION CONDITIONS:**

- The centerline is never placed further left than 8 pixels from the leftmost pixel of the sign.
- The centerline is never placed further right than 8 pixels from the rightmost pixel of the sign.

**7.10.3.3.3 Middle position****RULE:**

The Middle position is treated as though it were a one-line sign with as many rows as the sign is tall. Each line of text on the sign is prescanned to determine the largest piece of text (or graphic) to be displayed. The line of text is then vertically centered based on that largest piece of text or graphic. For example, if you have a line of text which has mostly 5-high characters, but has one 10-high character, then this line is considered a 10-high line. Assuming that this is a 24-row sign, this would leave 14 extra rows so there would be 7 blank rows on top and 7 on the bottom ( $7+10+7=24$ ). All text and graphics are then lined up on this new virtual bottom (the 21st line) and treated the same as in a one-line sign.

**EXCEPTION CONDITIONS:**

- If a graphic is received that is taller than what the sign can display, then only the top most rows will be displayed.
- If a graphic is received that is longer than what a sign can display, then only the leftmost columns will be displayed.
- If a character font is not specified, then 7-high normal will be used.

**7.10.3.3.4 Fill position****RULE:**

On a 7000 series or an AlphaVision sign, the Fill position indicates that you wish to fit as much text on the screen as you can. Unlike the 4000 series signs, in the Fill position you can select characters larger than 7-high.

The sign will start from top of the screen working down. If you select a 15-high character set, then the sign will fit as many 15 row lines of text on the screen as possible. As soon as the sign detects that the next line will not fit, the sign will stop creating the current page and display it. The next page will begin with the line the did not fit. If the text does not use up the entire display, then the sign will center the text vertically, splitting the blank space between the top and the bottom.

**EXCEPTION CONDITIONS:**

- If a graphic is received that is taller than 7 rows high, then only the top 7 rows will be displayed.
- If a graphic is received that is longer than what the sign can display, then only the leftmost columns will be displayed.
- If a graphic is received that is smaller than 7 dots high, the graphic will be displayed from the bottom of the sign working up.
- If a character font is not specified, then 7-high normal will be used.

#### **7.10.3.4 Multiple-line character matrix sign example**

The sign will work exactly like the three-line full matrix signs (described in the previous section) with the following exceptions:

- If a mode other than Wipe is received, it is replace with the Hold mode.
- The sign will ignore all the following:
  - graphics
  - all character set commands, except 5- and 7-high normal
  - wide
  - double wide
  - double high
  - true descenders
  - proportional spacing
  - animations
- If a character font is not specified, then 7-high normal will be used.

## 7.11 Appendix K: Pass Through Command Examples

Pass Through commands are used to pass serial protocol to the internal network of AlphaEclipse 3600, RoadStar, and StreetSmart signs. Temperature probes, light sensors, and driver boards are the recipients of these commands.

These commands allow the user to communicate with the internal peripherals of the unit for diagnostic purposes. See “Pass through commands” on page 135 of more information on the “U7” and “U9” commands.

NOTE: Reference Table 5 on page 10 for a list of typecodes and their corresponding parts.

### 7.11.1 Read Turbo Adapter Version and Build Number (AlphaEclipse 3600 only)

Computer sends: [SOH]Z00[STX] EU7G0001FV [EOT]

Sign responds: [SOH]000[STX] EV01000001 [EOT]

**Table 71: Breakdown of sent command**

<b>Alpha Header:</b>	"[SOH]Z00[STX]"
<b>Command Code:</b>	"E" [45H]
<b>Register:</b>	"U" [55H]
<b>Sub-Command Code</b>	"7" [37H]
<b>Typecode:</b>	"G" [47H]
<b>Device Address:</b>	"00" [30H] [30H]
<b>Turbo Channel:</b>	"01" [30H] [31H]
<b>EZ Data: Command Code</b>	"F" [46H]
<b>EZData: Register</b>	"V" [56H]
<b>Termination:</b>	"[EOT]"

### 7.11.2 Read Light Sensor

Computer sends: [SOH]Z00[STX] EU7L01FI [EOT]

Sign responds: [SOH]001[STX] E102FF [EOT]

**Table 72: Breakdown of sent command**

<b>Alpha Header:</b>	"[SOH]Z00[STX]"
<b>Command Code:</b>	"E" [45H]
<b>Register:</b>	"U" [55H]
<b>Sub-Command Code:</b>	"7" [37H]
<b>Typecode:</b>	"L" [4CH]
<b>Device Address:</b>	"01" [30H 31H]
<b>EZ Data: Command Code</b>	"F" [46H]
<b>EZ Data: Register</b>	"I" [6CH]
<b>Termination:</b>	"[EOT]"

**7.11.3 Write Turbo Adapter MUX Control Command (channel 1)**

A special case exists for writing to the turbo adapter and display board.

Computer sends: [SOH]Z00[STX] EU7G0001EM01 [EOT]

Sign responds: [ACK]

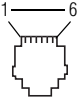
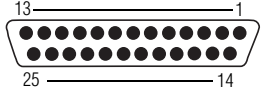

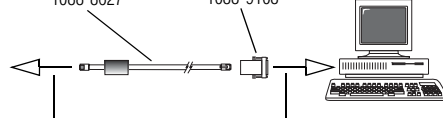
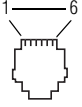
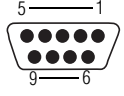

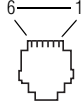
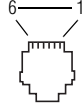

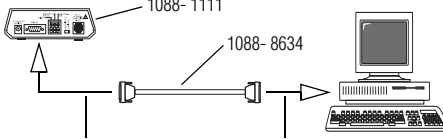

**Table 73: Breakdown of sent command**

<b>Alpha Header</b>	"[SOH]Z00[STX]"
<b>Command Code:</b>	"E" [45H]
<b>Register:</b>	"U" [55H]
<b>Sub-Command Code:</b>	"7" [37H]
<b>Typecode:</b>	"G" [47H]
<b>Device Address:</b>	"00" [30H] [30H]
<b>Turbo Channel:</b>	"01" [30H] [31H]
<b>EZ Data: Command Code</b>	"E" [45H]
<b>EZ Data: Register</b>	"M" [4DH]
<b>EZ Data: Data</b>	"01" [30H] [31H]
<b>Termination</b>	[EOT]



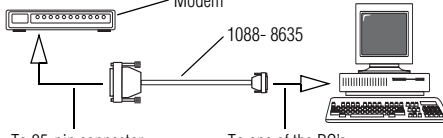

## 7.12 Appendix L: Network cabling and sign connector pinouts

### 7.12.1 Network cabling pinouts

Table 74: Network cabling pinouts

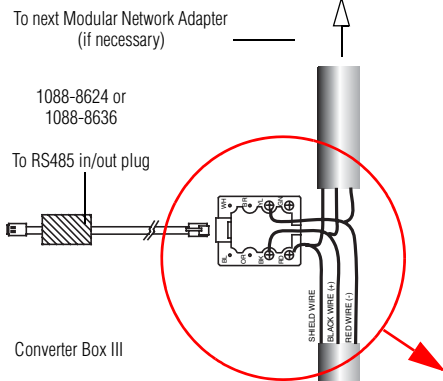
Part #	Item	Function	Pinout																																	
4370-0001C	25 pin sub-D / 6 pos. RJ11: 		  <p>RJ11 (female) pinouts: 1 = Signal GND 3 = RXD 4 = TXD</p> <p>25 pin / sub-D (female) pinouts: 2 = TXD 3 = RXD 4 = RTS 5 = CTS 6 = DSR 7 = Signal GND 8 = DCD 20 = DTR</p>																																	
1088-9108	9 pin sub-D / 6 pos. RJ11: 	 <p>1088-8625 or 1088-8627 4370-0001C or 1088-9108</p> <p>To the sign's RS232 or TTL port</p> <p>To one of the PC's RS232 (COM) ports.</p>	  <p>RJ11 (female) pinouts: 1 = Signal GND 3 = RXD 4 = TXD</p> <p>9 pin / sub-D (female) pinouts: 1 = DCD 2 = RXD 3 = TXD 4 = DTR 5 = Signal GND 6 = DSR 7 = RTS 8 = CTS</p>																																	
1088-8625 & 1088-8627	6-connector RS232 data cable:  1088-8625 is 25 feet long. 1088-8627 is 50 feet long.		  <p>Plug 1 (male) pinouts: 1 2 3 4 5 6</p> <p>Plug 2 (male) pinouts: 1 2 3 4 5 6</p>																																	
1088-8634	10 foot, 9 pin-to-9 pin type "A9" RS232 cable: 	 <p>1088-1111 1088-8634</p> <p>To 9-pin connector on back of Converter Box III</p> <p>To one of the PC's RS232 (COM) ports.</p>	<table border="1"> <thead> <tr> <th>PIN (female end)</th> <th>SIGNAL</th> <th>PIN (male end)</th> </tr> </thead> <tbody> <tr><td>SHIELD</td><td>GND</td><td>SHIELD</td></tr> <tr><td>3</td><td>TXD</td><td>3</td></tr> <tr><td>2</td><td>RXD</td><td>2</td></tr> <tr><td>7</td><td>RTS</td><td>7</td></tr> <tr><td>8</td><td>CTS</td><td>8</td></tr> <tr><td>6</td><td>DSR</td><td>6</td></tr> <tr><td>1</td><td>DCD</td><td>1</td></tr> <tr><td>4</td><td>DTR</td><td>4</td></tr> <tr><td>5</td><td>SIGNAL GROUND</td><td>5</td></tr> <tr><td>9</td><td>RI</td><td>9</td></tr> </tbody> </table>	PIN (female end)	SIGNAL	PIN (male end)	SHIELD	GND	SHIELD	3	TXD	3	2	RXD	2	7	RTS	7	8	CTS	8	6	DSR	6	1	DCD	1	4	DTR	4	5	SIGNAL GROUND	5	9	RI	9
PIN (female end)	SIGNAL	PIN (male end)																																		
SHIELD	GND	SHIELD																																		
3	TXD	3																																		
2	RXD	2																																		
7	RTS	7																																		
8	CTS	8																																		
6	DSR	6																																		
1	DCD	1																																		
4	DTR	4																																		
5	SIGNAL GROUND	5																																		
9	RI	9																																		
1088-8635	10 foot, 25 pin-to-9 pin type "B9" RS232 cable: 	 <p>Modem 1088-8635</p> <p>To 25-pin connector on back of modem</p> <p>To one of the PC's RS232 (COM) ports.</p>	<table border="1"> <thead> <tr> <th>PIN (male end)</th> <th>SIGNAL</th> <th>PIN (male end)</th> </tr> </thead> <tbody> <tr><td>SHIELD</td><td>GND</td><td>SHIELD</td></tr> <tr><td>2</td><td>RXD</td><td>2</td></tr> <tr><td>3</td><td>TXD</td><td>3</td></tr> <tr><td>7</td><td>SIGNAL GROUND</td><td>5</td></tr> <tr><td>8</td><td>DCD</td><td>1</td></tr> <tr><td>20</td><td>DTR</td><td>4</td></tr> </tbody> </table>	PIN (male end)	SIGNAL	PIN (male end)	SHIELD	GND	SHIELD	2	RXD	2	3	TXD	3	7	SIGNAL GROUND	5	8	DCD	1	20	DTR	4												
PIN (male end)	SIGNAL	PIN (male end)																																		
SHIELD	GND	SHIELD																																		
2	RXD	2																																		
3	TXD	3																																		
7	SIGNAL GROUND	5																																		
8	DCD	1																																		
20	DTR	4																																		

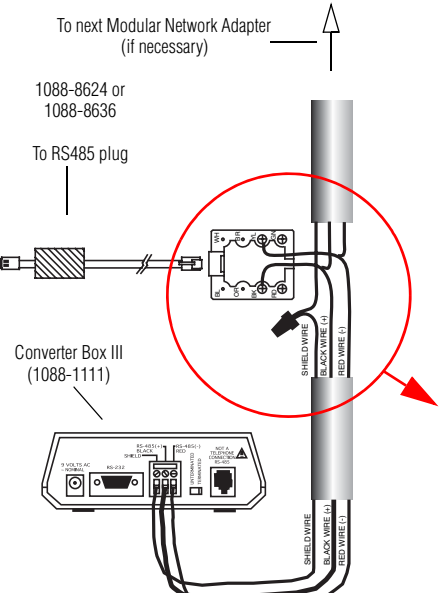
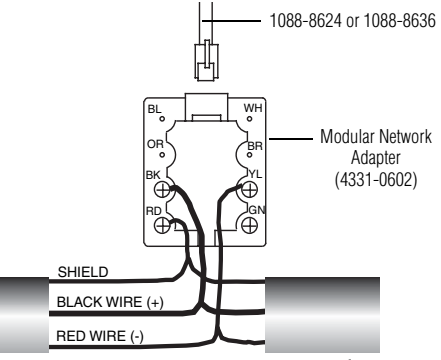

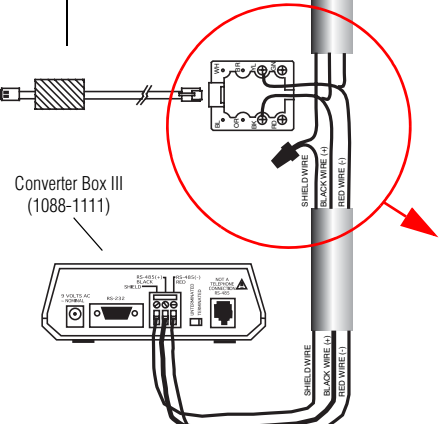
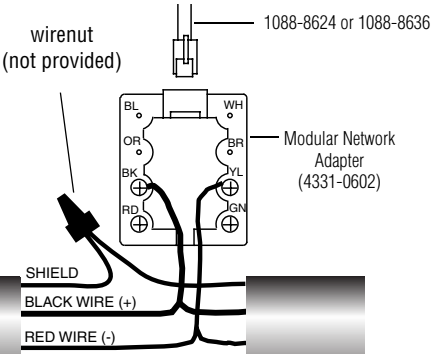
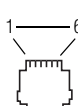
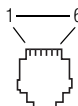
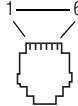

**Table 74: Network cabling pinouts**

<p>1088-8624 &amp; 1088-8636</p>  <p>1088-8624 is 8 feet long. 1088-8636 is 1 foot long.</p>	<p><b>If sign has 2 RJ11 plugs, wire as follows:</b></p> <p>To next Modular Network Adapter (if necessary)</p> <p>1088-8624 or 1088-8636</p> <p>To RS485 in/out plug</p>  <p>Converter Box III</p>	 <p>Plug 1 (male) pinouts: 1, 2, 3, 4</p> <p>Plug 2 (male) pinouts: 1, 2, 3, 4</p>
<p>4331-0602 Modular Network Adapter</p> 	<p><b>If sign has 1 RJ11 plug, wire as follows:</b></p> <p>To next Modular Network Adapter (if necessary)</p> <p>1088-8624 or 1088-8636</p> <p>To RS485 plug</p>  <p>Converter Box III (1088-1111)</p>	 <p>1088-8624 or 1088-8636</p> <p>Modular Network Adapter (4331-0602)</p> <p>SHIELD</p> <p>BLACK WIRE (+)</p> <p>RED WIRE (-)</p> <p>1088-8000 or 7122-0282</p>
<p>1088-8000 &amp; 7122-0282</p> <p>RS485 network cabling:</p>  <p>1088-8000 is a 1000 foot spool. 7122-0282 is a 100 foot spool.</p>	<p><b>If sign has 1 RJ11 plug, wire as follows:</b></p> <p>To next Modular Network Adapter (if necessary)</p> <p>1088-8624 or 1088-8636</p> <p>To RS485 plug</p>  <p>Converter Box III (1088-1111)</p>	 <p>wirenut (not provided)</p> <p>1088-8624 or 1088-8636</p> <p>Modular Network Adapter (4331-0602)</p> <p>SHIELD</p> <p>BLACK WIRE (+)</p> <p>RED WIRE (-)</p> <p>1088-8000 or 7122-0282</p>



7.12.2 Sign connector pinouts

Table 75: Sign connector pinouts

Type	Pinout	Sign type																	
		2.1" AlphaVision™	3.2" AlphaVision™	9000 Series	7000 Series	4000 Series	300 Series	200 Series	AlphaVision™ (Full Matrix)	Beta-Brite®	Big Dot®	Director™	Serial Clock	PPD®	Alpha Ticker™	Alpha Vision™ Info Tracker™	AlphaEclipse™	Alpha® Solar	NEMA 4, 4X, 12
RS485	 <p>Pinouts (female):                      1 = No connect                      2 = RS485 (+)                      3 = No connect                      4 = No connect                      5 = RS485 (-)</p>	●	●	●	●	●	●	●	●		●	●	●						
	<p>This connector is inside the sign.</p>  <p>RS485(-)                      RS485(+)                      SHIELD</p>																	●	
	 <p>Pinouts (female):                      1 = RS485 (-)                      2 = RS485 (+)                      3 = Shield                      4 = RS485 sync (-)                      5 = RS485 sync (+)</p>														●	●			
RS232 / RS485 / TTL	 <p>Pinouts (female):                      1 = GND                      2 = RS485 (+)                      3 = RXD                      4 = TXD                      5 = RS485 (-)</p>	●	●		●	●	●	●	●		●	●	●	●					●
RS232	 <p>Pinouts (female):                      1 = GND                      2 = No connect                      3 = RXD                      4 = TXD (TTL)                      5 = No connect</p>			●						●									
	<p>This connector is inside the sign.</p>  <p>Fused ISO +5V                      TXD                      RXD                      RS232 GND</p>																	●	
RJ45/Ethernet	 <p>Pinouts (female):                      1 = RTS                      2 = DTR                      3 = TX+                      4 = TX-                      5 = RX-                      6 = RX+                      7 = DSR</p>			●											●	●			

**Table 75: Sign connector pinouts**

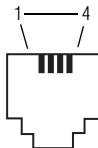
Type	Pinout	Sign type																	
		2.1" AlphaVision™	3.2" AlphaVision™	9000 Series	7000 Series	4000 Series	300 Series	200 Series	AlphaVision™ (Full Matrix)	Beta-Brite®	Big Dot®	Director™	Serial Clock	PPD®	Alpha Ticker™	AlphaVision™ Info Tracker™	AlphaEclipse™	Alpha® Solar	NEMA 4, 4X, 12
RJ11	 <p>Pinouts (female):                      1 = RS485+                      2 = No connect                      3 = No connect</p>						●							●					

### 7.13 Appendix M: Alpha 2.0 protocol additions

NOTE: As of the writing of this protocol manual, the Alpha 2.0 protocol is only available for the AlphaPremiere and AlphaEclipse signs.

The Alpha 2.0 protocol adds the following functions to the existing Alpha 1.0 protocol:

**Table 76: Alpha 2.0 protocol additions**

Function	Type	Description	Reference
Speed control	Control code ^0 0FH	Sets the amount of time to hold the current page and all subsequent pages.	"Speed control" on page 107
Sound control	Option "3" 33H for Write SPECIAL FUNCTION " (" 28H	Allows the creation and playing of multi-note sounds	"Sound control (AlphaPremiere 9000 only)" on page 108
Set Run File Times	Write/Read SPECIAL FUNCTION ":" 3AH	Allows setting/reading a start and end run time for a file configured with a standard time of NEVER.	"Set Run File Time" on page 110
Custom character sets	Write SPECIAL FUNCTION "<" 3CH	Programs up to four custom character sets.	"Custom character sets" on page 114
	Control codes: <ul style="list-style-type: none"> <li>• 1AH "W" (Five-high custom character set)</li> <li>• 1AH + "X" (Seven/Eight-high custom character set)</li> <li>• 1AH + "Y" (Ten-high custom character set)</li> <li>• 1AH + "Z" (Fifteen/Sixteen-high custom character set)</li> </ul>	Select s a custom character set.	"Control codes (00 – 1FH)" on page 81
Custom Automode table	Write/Read SPECIAL FUNCTION ">" 3EH	Creates a custom Automode table with up to 15 modes.	"Automode table" on page 117
Set timeout message	Command Code "T" 54H	Allows setting a timeout period after which a custom message will appear.	Table 6, "Command Codes," on page 11
Read/Set Dimming Control Register	Read SPECIAL FUNCTION "@" 3FH Write SPECIAL FUNCTION "@" 3FH	Allows enabling/disabling a sign's light sensor and setting the brightness level a sign dims to.	"Dimming Control Register" on page 118
ACK/NAK response	Write SPECIAL FUNCTION "s" 73H	Allows enabling/disabling of an ACK/NAK response after every <EOT>.	"Enable/Disable ACK/NAK response" on page 121
Read temperature log	Read SPECIAL FUNCTION "L" 4CH	Read a sign's temperature log	"Temperature Logging" on page 122
Read external temperature	Read SPECIAL FUNCTION "T" 54H	Reads the external temperature of a sign equipped with a functioning temperature probe.	"Read External Temperature command" on page 125
Read internal temperature	Read SPECIAL FUNCTION "TI" 54H 49H	Reads the internal temperature of a sign.	"Read Internal Temperature command" on page 126
Set Unit commands	Write/Read SPECIAL FUNCTION "U1", "U2", "U3", "U4", "U5", "U6", and "UN"	A series of commands that allows setting and reading sign parameters such as serial address.	"Set Unit commands" on page 128

#### 7.13.1 Speed control

This control code (Table 6 on page 11) sets the amount of time to hold the current page and all subsequent pages. For compatibility with some older AlphaVision signs, Speed control has three modes:

- Minutes mode
- Seconds mode
- Tenths-of-seconds mode

**7.13.1.1 Minutes Mode****Table 77: Speed control minutes mode syntax**

<b>Syntax:</b>	CMXX where: C = ^O (0FH) M = "M" (4DH) an indicator to switch to minutes mode XX = two ASCII hexadecimal numbers that represent the numbers of seconds to hold, ranging from "00" to "FF" (255) seconds
<b>Example:</b>	^O"1A" means: hold text for 26 (1AH) seconds

**7.13.1.2 Seconds mode****Table 78: Speed control seconds mode syntax**

<b>Syntax:</b>	CXX where: C = ^O (0FH) XX = two ASCII hexadecimal numbers that represent the numbers of seconds to hold, ranging from "00" to "FF" (255) seconds
<b>Example:</b>	^O"1A" means: hold text for 26 (1AH) seconds

**7.13.1.3 Tenths-of-seconds mode****Table 79: Speed control tenths-of-seconds mode syntax**

<b>Syntax:</b>	CIXXX where: C = ^O (0FH) I = "I" (54H) an indicator to switch to tenths-of-second mode XXX = three ASCII hexadecimal numbers that represent the number of tenths-of-seconds to hold
<b>Example:</b>	^O"1T58" means: hold text for 1 minute (258H = 600 x 0.1 sec = 60 seconds)

**7.13.2 Sound control (AlphaPremiere 9000 only)**

There are two new options for the Write SPECIAL FUNCTION Command Code Generate Speaker Tone ("(" 28H), see page 22:

- Store a programmable sound
- Trigger a programmable sound

NOTE: A Clear Memory Write SPECIAL FUNCTION command (" \$" 24H) will delete all sound files.

7.13.2.1 Store a programmable sound

Table 80: Store a programmable sound syntax

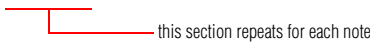
<b>Syntax:</b>	<p>C L O N A V R D P where:</p> <p> this section repeats for each note</p> <p>C = "3" (33H) follows the Generate Speaker Tone SPECIAL FUNCTION label: (" 28H (see page 22).</p> <p>L = one ASCII hexadecimal character that represents the sound file label. Valid characters are 20H through 2FH which allows up to 16 sounds files.</p> <p>O = one ASCII hexadecimal character that represents the octave. Valid entries are "0" through "7".</p> <p>N = one ASCII hexadecimal character that represents the musical note. Valid entries are "A" through "G".</p> <p>Each sound file can have up to 32 notes.</p> <p>A = one ASCII hexadecimal character that represents the accidental. Valid entries are: "N" for Natural, "S" for sharp, and "F" for flat. (<i>Currently only Naturals are implemented</i>)</p> <p>V = one ASCII hexadecimal character that represents the sound volume. Valid entries are "0" through "F".</p> <p>R = one ASCII hexadecimal character that represents the number of times to repeat the musical note. Valid entries are from "0" through "F".</p> <p>D = one ASCII hexadecimal character that represents the musical note's on duration in 0.1 second increments. Valid entries are from "0" through "F" where "0" = turn off the sound file and "F" = musical note will stay on until another trigger.</p> <p>P = one ASCII hexadecimal character that represents the pause or off time duration in 0.1 second increments. Valid entries are from "0" through "F".</p>
<b>Example:</b>	<p>"3\$4CNF1524ENF1524GNF152" means :</p> <p>sound file label = "\$"</p> <p>octave = "4"</p> <p>note = "C"</p> <p>accidental = "N" ("N" = Natural)</p> <p>volume = "F" (15 = maximum)</p> <p>repeat note = "1" (once)</p> <p>duration of the note = "5" (0.5 sec = 5 x 0.1)</p> <p>pause time before next note = "2" (0.2 sec = 2 x 0.1)</p> <p>octave = "4"</p> <p>note = "E"</p> <p>accidental = "N" ("N" = Natural)</p> <p>volume = "F" (15 = maximum)</p> <p>repeat note = "1" (once)</p> <p>duration of the note = "5" (0.5 sec = 5 x 0.1)</p> <p>pause time before next note = "2" (0.2 sec = 2 x 0.1)</p> <p>octave = "4"</p> <p>note = "G"</p> <p>accidental = "N" ("N" = Natural)</p> <p>volume = "F" (15 = maximum)</p> <p>repeat note = "1" (once)</p> <p>duration of the note = "5" (0.5 sec = 5 x 0.1)</p> <p>pause time before next note = "2" (0.2 sec = 2 x 0.1)</p>

7.13.2.2 Trigger a programmable sound

If a sound file is currently running and a new sound file trigger occurs, then the new sound file trigger will immediately replace an old sound file.

Table 81: Trigger a programmable sound syntax

<b>Syntax:</b>	<p>C L where:</p> <p>C = "4" (34H) follows the Generate Speaker Tone SPECIAL FUNCTION label: (" 28H (see page 22).</p> <p>L = one ASCII hexadecimal character that represents the sound file label to be triggered. Valid characters are 20H through 2FH.</p>
<b>Example:</b>	<p>"49" means:</p> <p>play sound file "9"</p>

### 7.13.3 Set Run File Time

The Set Run File Time SPECIAL FUNCTION allows setting a start and end run time for a file configured with a standard run time of NEVER. That is, if the file can not run for another reason, the sign will check to see if there is a valid Run File Time for the file. If a valid file exists and the sign's current time is within the specified start and stop period, the file will run.

In determining the start and end time window criteria, a run time period begins when the minute reaches the start time. A run time period ends when it reaches the end time. (If start time = end time, then the file will not run.)

Multiple start and end times per file are acceptable. The total number (combined for all files) of start and end times that can be stored is 100.

All start and end times are erased with the Clear Memory (E\$) Set Memory Configuration Write SPECIAL FUNCTION command (page 21).

**Table 82: Set Run File Time(s) packet format**

Standard transmission packet (see page 10)	<NUL> ^@	<NUL> ^@	<NUL> ^@	<NUL> ^@	<NUL> ^@	<SOH> ^A	Type Code	Sign Address	<STX> ^B	Command Code	Data Field	<EOT> ^D
	Write SPECIAL FUNCTION Set Run File Time(s)										45H "E"	3AH ":"
	File Label	Start Day	Start Month	Start Year	Start Time	End Day	End Month	End Year	End Time			
	<b>A</b>	<b>B</b>	<b>C</b>	<b>D</b>	<b>E</b>	<b>F</b>	<b>G</b>	<b>H</b>	<b>I</b>			

  

Item	Name	Description
<b>A</b>	File Label	One ASCII character that represents a valid file name.
<b>B</b>	Start Day	Start day represented by two ASCII decimal digits. Valid entries range from "01" (30H)(31H) through "31" (33H)(31H), depending on the month.
<b>C</b>	Start Month	Start month represented by two ASCII decimal digits. Valid entries range from "01" (30H)(31H) through "12" (31H)(32H).
<b>D</b>	Start Year	Start year represented by four ASCII decimal digits. Valid entries range from "0000" (30H)(30H)(30H)(30H) through "9999" (39H)(39H)(39H)(39H).
<b>E</b>	Start Time	Start time in 24-hour format represented by four ASCII decimal digits. Valid entries range from "0000" (30H)(30H)(30H)(30H) through "2359" (32H)(33H)(35H)(39H).
<b>F</b>	End Day	End day represented by two ASCII decimal digits. Valid entries range from "01" (30H)(31H) through "31" (33H)(31H), depending on the month.
<b>G</b>	End Month	End month represented by two ASCII decimal digits. Valid entries range from "01" (30H)(31H) through "12" (31H)(32H).
<b>H</b>	End Year	End year represented by four ASCII decimal digits. Valid entries range from "0000" (30H)(30H)(30H)(30H) through "9999" (39H)(39H)(39H)(39H).
<b>I</b>	End Time	End time in 24-hour format represented by four ASCII decimal digits. Valid entries range from "0000" (30H)(30H)(30H)(30H) through "2359" (32H)(33H)(35H)(39H).



The data from the sign is returned in the following format:

**Table 84: Read Run File Time file response packet format**

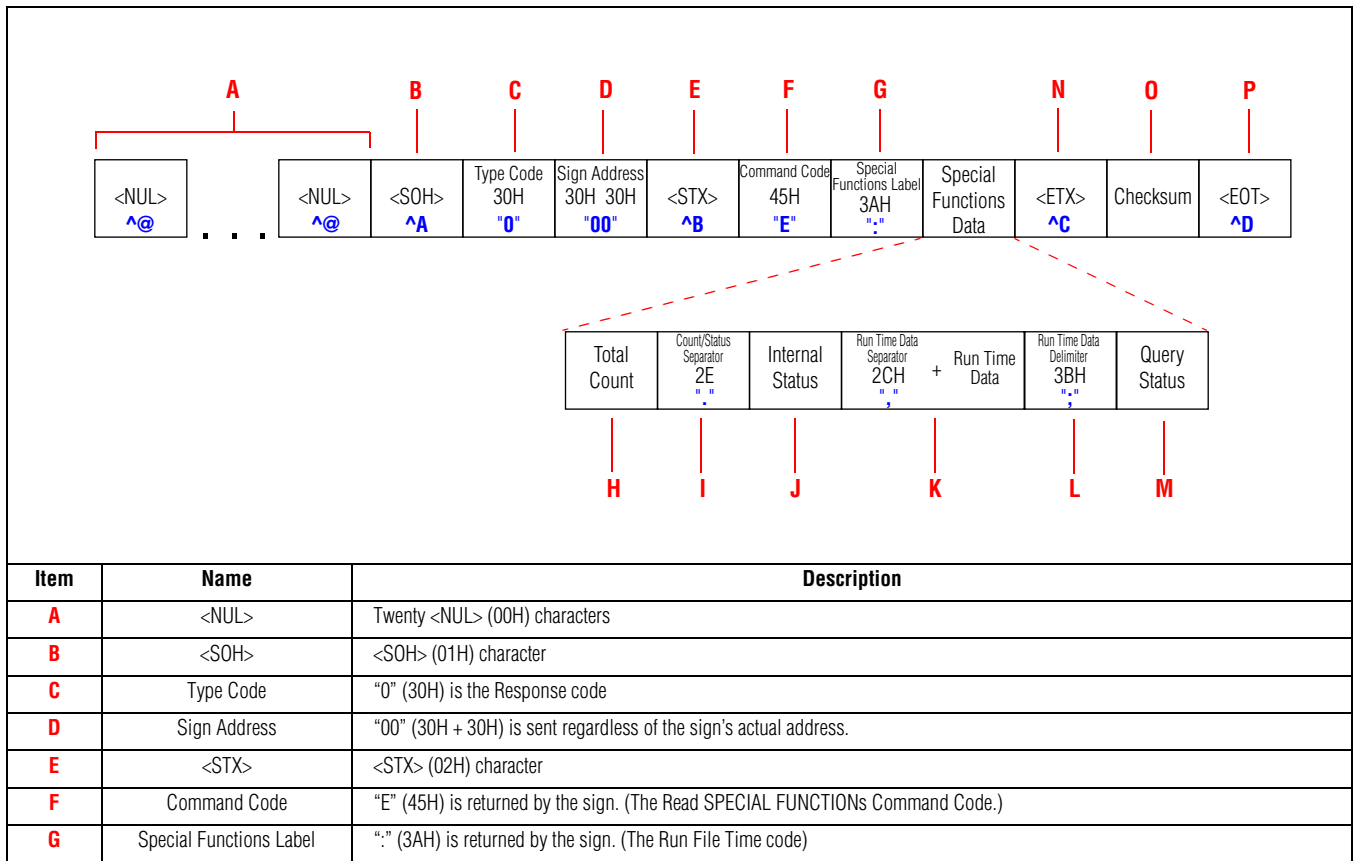



**Table 84: Read Run File Time file response packet format**

<b>H</b>		Total Count	Two ASCII hexadecimal digits that represent the <i>total</i> number of run times entries for <i>all</i> files.
<b>I</b>		Count/Status Separator	“.” (2EH) is used to separate Total Count from Internal Status.
<b>J</b>		Internal Status	Two ASCII hexadecimal digits that represent the current internal entry table status. Status values are: <ul style="list-style-type: none"> <li>• “00” = OKAY — no problem</li> <li>• “01” = NOROOM — out of storage</li> <li>• “02” = BADFILE — file not in configuration, no such file</li> <li>• “03” = BADDATA — data (time/date) invalid</li> <li>• “04” = INCOMPLETE — error during transfer of new data</li> <li>• “05” = LOCKED — attempted to access a locked file</li> <li>• “09” = NOTFOUND — attempted to delete/retrieve entries for a file that isn’t in the table</li> </ul>
<b>K</b>	Special Function Data	Run Time Data Separator + Run Time Data	More than one Run Time Data entry can be returned. Each Run Time Data entry will be returned in this format: S F D D M M Y Y Y Y T T T T E E N N Z Z Z Z U U U U where: S = “.” (2EH) Run Time Data separator F = File Label D D = Start day represented by two ASCII decimal digits. Valid entries range from “01” (30H)(31H) through “31” (33H)(31H), depending on the month. M M = Start month represented by two ASCII decimal digits. Valid entries range from “01” (30H)(31H) through “12” (31H)(32H). Y Y Y Y = Start year represented by four ASCII decimal digits. Valid entries range from “0000” (30H)(30H)(30H)(30H) through “9999” (39H)(39H)(39H)(39H). T T T T = Start time in 24-hour format represented by four ASCII decimal digits. Valid entries range from “0000” (30H)(30H)(30H)(30H) through “2359” (32H)(33H)(35H)(39H). E E = End day represented by two ASCII decimal digits. Valid entries range from “01” (30H)(31H) through “31” (33H)(31H), depending on the month. N N = End month represented by two ASCII decimal digits. Valid entries range from “01” (30H)(31H) through “12” (31H)(32H). Z Z Z Z = End year represented by four ASCII decimal digits. Valid entries range from “0000” (30H)(30H)(30H)(30H) through “9999” (39H)(39H)(39H)(39H). U U U U = End time in 24-hour format represented by four ASCII decimal digits. Valid entries range from “0000” (30H)(30H)(30H)(30H) through “2359” (32H)(33H)(35H)(39H).
<b>L</b>		Run Time Data Delimiter	“;” (3BH) is used to indicate the end of Run Time Data.
<b>M</b>		Query Status	Two ASCII hexadecimal digits that represent the status of this entry table status. Status values are: <ul style="list-style-type: none"> <li>• “00” = OKAY — no problem</li> <li>• “01” = NOROOM — out of storage</li> <li>• “02” = BADFILE — file not in configuration, no such file</li> <li>• “03” = BADDATA — data (time/date) invalid</li> <li>• “04” = INCOMPLETE — error during transfer of new data</li> <li>• “05” = LOCKED — attempted to access a locked file</li> <li>• “09” = NOTFOUND — attempted to delete/retrieve entries for a file that isn’t in the table</li> </ul>
<b>N</b>		<ETX>	<ETX> (03H) character
<b>O</b>		Checksum	Four ASCII digits that represent a 16-bit hexadecimal summation of all transmitted data from the previous <STX> through the previous <ETX> inclusive. The most significant digit is first.
<b>P</b>		<EOT>	<EOT> (04H) character

### 7.13.4 Custom character sets

#### 7.13.4.1 Custom character set memory requirements

Four custom character sets can be programmed. These sets will work just like the standard character sets. Character sets should allow for characters 20H to C1H. This is the full ASCII set minus the control codes.

Custom character sets take up memory (RAM) in a sign:

**Table 85: Custom character set memory requirements**

Font	Characters	Memory requirements (bytes)
5 high	20H - 60H (lowercase not used)	320
7 high	20H - C1H	1127
8 high	20H - C1H	1288 (AlphaEclipse™ 3500 1-line sign)
10 high	20H - C1H	1610
15 high	20H - C1H	2415 (AlphaPremiere 9000 signs)
16 high	20H - C1H	2576 (AlphaEclipse outdoor signs)
If all sets are used, then 9336 bytes are required.		

#### 7.13.4.2 Custom character set identifiers

Custom character set identifiers (see the 1AH control code in “Appendix G: Alpha protocol ASCII table” on page 81):

- 1AH + “W” = Five high custom character set
- 1AH + “X” = Seven/Eight high custom character set
- 1AH + “Y” = Ten high custom character set
- 1AH + “Z” = Fifteen/Sixteen high custom character set

#### 7.13.4.3 Program Custom Character Sets

To create a custom character set, a new Write SPECIAL FUNCTION code (“<”) is used:

**Table 86: Program Custom Character Sets packet format**

Item	Name	Description
<b>A</b>	Command Code	“E” (45H) = Write SPECIAL FUNCTION file
<b>B</b>	Special Functions Label	“<” (3CH) = Program Custom Character Set

Standard transmission packet (see “Standard transmission packet (“1-byte” or “^A”) format” on page 10):

<NUL> ^@	<NUL> ^@	<NUL> ^@	<NUL> ^@	<NUL> ^@	<SOH> ^A	Type Code	Sign Address	<STX> ^B	<b>Command Code</b>	<b>Data Field</b>	<EOT> ^D											
<table border="1" style="margin: 10px auto;"> <tr> <td>45H “E”</td> <td>3CH “&lt;”</td> <td>Character Set Label</td> <td>Character to Program</td> <td>Character Columns</td> <td>Character Data</td> </tr> <tr> <td style="text-align: center;"><b>A</b></td> <td style="text-align: center;"><b>B</b></td> <td style="text-align: center;"><b>C</b></td> <td style="text-align: center;"><b>D</b></td> <td style="text-align: center;"><b>E</b></td> <td style="text-align: center;"><b>F</b></td> </tr> </table>											45H “E”	3CH “<”	Character Set Label	Character to Program	Character Columns	Character Data	<b>A</b>	<b>B</b>	<b>C</b>	<b>D</b>	<b>E</b>	<b>F</b>
45H “E”	3CH “<”	Character Set Label	Character to Program	Character Columns	Character Data																	
<b>A</b>	<b>B</b>	<b>C</b>	<b>D</b>	<b>E</b>	<b>F</b>																	

**Table 86: Program Custom Character Sets packet format**

<b>C</b>	Character Set Label	One ASCII character. Valid entries are: <ul style="list-style-type: none"> <li>• “W” (57H) = Five high custom character set</li> <li>• “X” (58H) = Seven/Eight high custom character set</li> <li>• “Y” (59H) = Ten high custom character set</li> <li>• “Z” (5AH) = Fifteen/Sixteen high custom character set</li> </ul>
<b>D</b>	Character to Program	Two ASCII characters. Valid entries are: <ul style="list-style-type: none"> <li>• “20” through “60” for Five high set</li> <li>• “20” through “C1” for all other sets</li> </ul> <p>NOTE: To clear a character set, send “00”. For example, to clear the 10 high character set, send: ^AZ00^BE&lt;Y00^D.</p>
<b>E</b>	Character Columns	Two ASCII characters. Valid entries are: <ul style="list-style-type: none"> <li>• Maximum of 6 for Five high and Seven/Eight high sets</li> <li>• Maximum of 8 for Ten high set</li> <li>• Maximum of 11 for Fifteen/Sixteen high set</li> </ul>
<b>F</b>	Character Data	Two hexadecimal bytes for <i>each</i> character row, starting with the top of a character. Both bytes combine to form a bitmapped representation of a character row. Number of rows is dependent on the character set.

**7.13.4.4 Program custom character example**

This example shows how to create a single 10 high custom character — a Smiley Face:

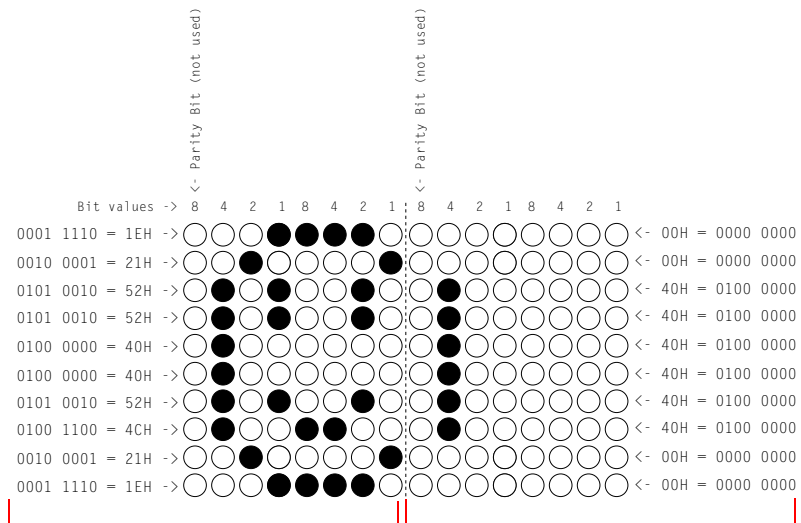

A custom character is transmitted by sending one of its rows at a time, starting from the top of the character. Each character row is defined by two bitmapped bytes. For example, 1EH 00H defines the first character row above. The 8th bit in both bytes is not used and is always 0.

**Table 87: Program custom character (Smiley Face) example**

<code>&lt;NUL&gt;&lt;NUL&gt;&lt;NUL&gt;&lt;NUL&gt;&lt;NUL&gt;&lt;SOH&gt;”Z00”&lt;STX&gt;”E&lt;Y2008”1E00 2100 5240 5240 4040 4040 5240 4C40 2100 1E00&lt;EOT&gt;</code>			
<b>A</b>	<b>B</b>	<b>C</b>	<b>D</b>
<b>E</b>	<b>F</b>	<b>G</b>	<b>H</b>
<b>I</b>	<b>J</b>	<b>K</b>	<b>L</b>
This is <i>hexadecimal</i> , not ASCII, data. A space is used between each pairs of bytes for ease of reading.			
Item	Name	Value	Description
<b>A</b>	<NUL>	00H	These five <NUL>s cause a sign to lock onto a baud rate. (This is also called “autobauding”.)
<b>B</b>	<SOH>	01H	Start Of Header character
<b>C</b>	Type Code	“Z”	“Z” (5AH) means that this transmission is directed to all signs.
<b>D</b>	Sign Address	“00”	“00” (30H 30H) means all signs on the network should “listen” to this transmission.
<b>E</b>	<STX>	02H	Start of TeXt character

**Table 87: Program custom character (Smiley Face) example**

<b>F</b>	Command Code	"E"	"E" (45H) is the "Write SPECIAL FUNCTION example" on page 69.	
<b>G</b>	Special Functions Label	"<"	"<" (3CH) Program Custom Character Set command	
<b>H</b>	Character Set Label	"Y"	"Y" (59H) 10-high custom character set	
<b>I</b>	Character to Program	"20"	This is normally the ASCII space character.	
<b>J</b>	Character Columns	"08"	The maximum number of columns for the 10-high character set = 8.	
<b>K</b>	Data Field	Character Data	1EH 00H	= (00011110 00000000) bitmapped representation of character row 1 (top)
			21H 00H	= (00100001 00000000) bitmapped representation of character row 2
			52H 40H	= (01010010 01000000) bitmapped representation of character row 3
			52H 40H	= (01010010 01000000) bitmapped representation of character row 4
			40H 40H	= (01000000 01000000) bitmapped representation of character row 5
			40H 40H	= (01000000 01000000) bitmapped representation of character row 6
			52H 40H	= (01010010 01000000) bitmapped representation of character row 7
			4CH 40H	= (01001100 01000000) bitmapped representation of character row 8
			21H 00H	= (00100001 00000000) bitmapped representation of character row 9
			1EH 00H	= (00011110 00000000) hexadecimal bitmapped representation of character row 10 (bottom)
<b>L</b>	<EOT>	04H	End Of Transmission character	

### 7.13.5 Automode table

This SPECIAL FUNCTION command (“>” 3EH) is used to create (or read) a custom Automode table.

When a message has no modes specified, then the modes in the Automode table will be used to display the message. If the Automode table is cleared or not programmed, then the default Automode table modes are used.

#### 7.13.5.1 Set Automode table command packet format

**Table 88: Set Automode table command packet format**

Standard transmission packet (see “Standard transmission packet (“1-byte” or “^A”) format” on page 10):

<code>&lt;NUL&gt;</code>	<code>&lt;NUL&gt;</code>	<code>&lt;NUL&gt;</code>	<code>&lt;NUL&gt;</code>	<code>&lt;NUL&gt;</code>	<code>&lt;SOH&gt;</code>	Type Code	Sign Address	<code>&lt;STX&gt;</code>	<b>Command Code</b>	<b>Data Field</b>	<code>&lt;EOT&gt;</code>
<code>^@</code>	<code>^@</code>	<code>^@</code>	<code>^@</code>	<code>^@</code>	<code>^A</code>			<code>^B</code>			<code>^D</code>

45H	3EH	Mode(s)
<code>"E"</code>	<code>"&gt;"</code>	
A	B	C

Item	Name	Description
A	Command Code	"E" (45H) = Write SPECIAL FUNCTION file
B	Special Functions Label	">" (3EH) = Program Custom Character Set
C	Mode(s)	<p>From 2 – 30 ASCII characters in 2-byte pairs where each ASCII pair specifies a mode. This allows up to 15 modes to be programmed into the Automode table. If more than 15 modes are programmed, the command is ignored. If no modes are specified, then the table is cleared.</p> <p>Most Standard Modes (see Table 65, “Standard Modes,” on page 89) only require a single ASCII character — for example “g” (67H) for ROLL LEFT Mode. For these 1-byte Modes, the ASCII character “0” (30H) is added. Therefore, ROLL LEFT would be represented by the ASCII pair “g0”.</p> <p>On the other hand, the SPECIAL Standard Mode (see Table 65, “Standard Modes,” on page 89), requires two ASCII characters: “n” (6EH) plus another character which specifies a Special Mode (see Table 66 on page 89) or a Special Graphic (see Table 67 on page 90).</p> <p>For example, to program Rotate, Hold, Flash, and Slide modes in the Automode table, send:  <code>&lt;NUL&gt;&lt;NUL&gt;&lt;NUL&gt;&lt;NUL&gt;&lt;NUL&gt;&lt;SOH&gt;"Z00"&lt;STX&gt;"E&gt;a0b0c0n5"&lt;EOT&gt;</code>.</p> <p>To clear the Automode table, send:  <code>&lt;NUL&gt;&lt;NUL&gt;&lt;NUL&gt;&lt;NUL&gt;&lt;NUL&gt;&lt;SOH&gt;"Z00"&lt;STX&gt;"E"&lt;EOT&gt;</code></p>

#### 7.13.5.2 Read Automode table command packet format

**Table 89: Read Automode table command packet format**

Standard transmission packet (see “Standard transmission packet (“1-byte” or “^A”) format” on page 10):

<code>&lt;NUL&gt;</code>	<code>&lt;NUL&gt;</code>	<code>&lt;NUL&gt;</code>	<code>&lt;NUL&gt;</code>	<code>&lt;NUL&gt;</code>	<code>&lt;SOH&gt;</code>	Type Code	Sign Address	<code>&lt;STX&gt;</code>	<b>Command Code</b>	<b>Data Field</b>	<code>&lt;EOT&gt;</code>
<code>^@</code>	<code>^@</code>	<code>^@</code>	<code>^@</code>	<code>^@</code>	<code>^A</code>			<code>^B</code>			<code>^D</code>

46H	3EH	Mode(s)
<code>"F"</code>	<code>"&gt;"</code>	
A	B	C

Item	Name	Description
A	Command Code	"F" (46H) = Read SPECIAL FUNCTION file
B	Special Functions Label	">" (3EH) = Program Custom Character Set
C	Mode(s)	From 2 – 30 ASCII characters in 2-byte pairs where each ASCII pair specifies a mode.

### 7.13.6 Set Timeout Message

This Command Code allows you to specify a timeout period after which a custom message will appear on the sign.

**Table 90: Set Timeout Message syntax**

Standard transmission packet (see "Standard transmission packet ("1-byte" or "AA") format" on page 10):

<NUL> ^@	<NUL> ^@	<NUL> ^@	<NUL> ^@	<NUL> ^@	<SOH> ^A	Type Code	Sign Address	<STX> ^B	<b>Command Code</b>	<b>Data Field</b>	<EOT> ^D
-------------	-------------	-------------	-------------	-------------	-------------	--------------	-----------------	-------------	-------------------------	-----------------------	-------------

54H "T"	Timeout Period	Timeout Message
------------	-------------------	--------------------

**A**      **B**      **C**

Item	Name	Description
<b>A</b>	Command Code	"T" (54H) = Set Timeout Message
<b>B</b>	Timeout Period	Three ASCII hexadecimal digits used to set the number of 1/10s of seconds in which if no serial transmission is received, then the Timeout Message will be displayed. Valid values range from: "000" to "FFF".
<b>C</b>	Timeout Message	ASCII character message

**NOTE:** The Clear Memory command will not delete a Timeout Message. To clear a Timeout Message, either (1) set the clear memory DIP switch and cycle power or (2) send a NULL message as follows: <SOH>"Z00"<STX>"T000"<EOT>.

### 7.13.7 Dimming Control Register

The Dimming Control Register controls the brightness percentage when an AlphaEclipse sign is in dim mode. The register also enables or disables a sign's light sensor. Changing the brightness level in this register also alters the brightness level that the Set Dimming Register Write SPECIAL FUNCTION (page 23) dims to.

#### 7.13.7.1 Set Dimming Control Register command packet format

**Table 91: Set Dimming Control Register syntax**

Standard transmission packet (see "Standard transmission packet ("1-byte" or "AA") format" on page 10):

<NUL> ^@	<NUL> ^@	<NUL> ^@	<NUL> ^@	<NUL> ^@	<SOH> ^A	Type Code	Sign Address	<STX> ^B	<b>Command Code</b>	<b>Data Field</b>	<EOT> ^D
-------------	-------------	-------------	-------------	-------------	-------------	--------------	-----------------	-------------	-------------------------	-----------------------	-------------

45H "E"	40H "@"	Sensor Enable	Brightness Level
------------	------------	------------------	---------------------

**A**      **B**      **C**      **D**

Item	Name	Description
<b>A</b>	Command Code	"E" (45H) = Write SPECIAL FUNCTION file
<b>B</b>	Special Functions Label	"@" (40H) = Set Dimming Control Register

**Table 91: Set Dimming Control Register syntax**

<b>C</b>	Sensor Enable	One ASCII character. Valid entries are: "0" 30H = sign sensor OFF "1" 31H = sign sensor ON
<b>D</b>	Brightness Level	Two ASCII characters. Valid entries are: "00" through "12" = 12.5% of full brightness "13" through "25" = 25% of full brightness "26" through "37" = 37.5% of full brightness "38" through "50" = 50% of full brightness "51" through "62" = 62.5% of full brightness "63" through "75" = 75% of full brightness "76" through "87" = 87.5% of full brightness "88" through "99" = 100% of full brightness

**7.13.7.2 Read Dimming Control Register command packet format**

"@" — Sending "F@" will read the dimming percentage currently in this register, current brightness level, whether the photocell is enabled or disabled, and what is currently causing the display to dim. s

**Table 92: Read Dimming Control Register command packet format**

<NUL> ^@	<NUL> ^@	<NUL> ^@	<NUL> ^@	<NUL> ^@	<SOH> ^A	Type Code	Sign Address	<STX> ^B	Command Code	Data Field	<EOT> ^D			
						<table border="1"> <tr> <td style="text-align: center;">45H "F"</td> <td style="text-align: center;">40H "@"</td> <td style="text-align: center;"><b>Special Functions Data</b></td> </tr> </table>		45H "F"	40H "@"	<b>Special Functions Data</b>				
45H "F"	40H "@"	<b>Special Functions Data</b>												
						<b>A</b>	<b>B</b>							
<b>Special Functions Label</b>		<b>Special Functions Data</b> Command Code "F" (46H) reads sign parameters.												
<b>A</b>	Command Code	"F" (46H) = Read SPECIAL FUNCTION command												
<b>B</b>	Special Functions Label	"@ " (40H) = Read Dimming Control Register												
<b>C</b>	Special Functions Data	This data is returned in the response packet (see below).												

**Table 93: Read Dimming Control Register command example 1**

<p style="text-align: center;">&lt;NUL&gt;&lt;NUL&gt;&lt;NUL&gt;&lt;NUL&gt;&lt;NUL&gt;&lt;SOH&gt;"Z00"&lt;STX&gt;"F@"&lt;EOT&gt;</p> <p style="text-align: center;"> <span style="margin-right: 100px;">A</span> <span style="margin-right: 20px;">B</span> <span style="margin-right: 20px;">C</span> <span style="margin-right: 20px;">D</span> <span style="margin-right: 20px;">E</span> <span style="margin-right: 20px;">F</span> <span style="margin-right: 20px;">G</span> <span style="margin-right: 20px;">H</span> </p>			
Item	Name	Value	Description
<b>A</b>	<NUL>	00H	These five <NUL>s cause a sign to lock onto a baud rate. (This is also called "autobauding".)
<b>B</b>	<SOH>	01H	Start Of Header character
<b>C</b>	Type Code	"Z"	"Z" (5AH) means that all signs should respond to this command.
<b>D</b>	Sign Address	"00"	"00" (30H 30H) means that this command is sent to all signs.
<b>E</b>	<STX>	02H	Start of TeXt character
<b>F</b>	Command Code	"F"	"F" (46H) is the "Read SPECIAL FUNCTION" Command Code. (See Table 16, "Read SPECIAL FUNCTION Command Code format — "F" (46H)," on page 29.)
<b>G</b>	Data Field	Special Functions Label "@ "	Read Dimming Control Register command.
<b>H</b>	<EOT>	04H	End Of Transmission character

Table 94: Read Dimming Control Register response example 2

Item	Name	Value	Description
<b>A</b>	<NUL>	00H	These five <NUL>s cause a sign to lock onto a baud rate. (This is also called "autobauding".)
<b>B</b>	<SOH>	01H	Start Of Header character
<b>C</b>	Type Code	"0"	"0" (30H) is the Response code.
<b>D</b>	Sign Address	"00"	"00" (30H 30H) means that this command is sent to all signs.
<b>E</b>	<STX>	02H	Start of TeXt character
<b>F</b>	Command Code	"E"	"E" (45H) is the response to a Read SPECIAL FUNCTION command.
<b>G</b>	Special Functions Label	"@"	Read Dimming Control Register command.
<b>H</b>	Data Field	"05010010000"	<p>Eleven ASCII decimal characters in the following format: AAABBBCCDEFG where:</p> <ul style="list-style-type: none"> <li>• AAA = a percentage that represents the current dimming control register setting. This setting is the percentage that the display will dim if the sign's photocell causes dimming. Valid values are from "000" to "100".</li> <li>• BBB = a percentage that represents the sign's current brightness level. If the sign is dimmed because of E, F, G, or the Set Dimming Time command (page 23) when this command is sent, the dimming level will be returned to the current brightness level. Valid values are from "000" to "100".</li> <li>• C = sign photocell enabled/disabled flag. <ul style="list-style-type: none"> <li>• "0" (30H) = photocell disabled</li> <li>• "1" (31H) = photocell enabled</li> </ul> </li> <li>• D = sign photocell dimming <ul style="list-style-type: none"> <li>• "0" (30H) = sign photocell is <u>not</u> causing sign dimming</li> <li>• "1" (31H) = sign photocell is causing sign dimming</li> </ul> </li> <li>• E = display load dimming <ul style="list-style-type: none"> <li>• "0" (30H) = display load is <u>not</u> causing sign dimming</li> <li>• "1" (31H) = display load is causing sign dimming</li> </ul> </li> <li>• F = internal or external display temperature dimming <ul style="list-style-type: none"> <li>• "0" (30H) = display temperature is <u>not</u> causing sign dimming</li> <li>• "1" (31H) = display temperature is causing sign dimming</li> </ul> </li> <li>• G = Set Dimming Time ("E/" page 23) dimming <ul style="list-style-type: none"> <li>• "0" (30H) = Set Dimming Time command is <u>not</u> causing sign dimming</li> <li>• "1" (31H) = Set Dimming Time command is causing sign dimming</li> </ul> </li> </ul>
<b>I</b>	<EOT>	04H	End Of Transmission character



### 7.13.8 Enable/Disable ACK/NAK response

When the ACK/NAK response is enabled, a sign will respond with one of the following transmissions whenever an <EOT> occurs:

- <ACK>[Serial Error Status Register value] — response to a good serial transmission
- <NAK>[Serial Error Status Register value] — response to an incorrect serial transmission

NOTE: The Serial Error Status Register value is one ASCII character that represents the bitmapped value of the Serial Error Status Register (page 31).

**Table 95: Enable/Disable ACK/NAK packet format**

Standard transmission packet (see "Standard transmission packet ("1-byte" or "^A") format" on page 10):

<NUL> ^@	<NUL> ^@	<NUL> ^@	<NUL> ^@	<NUL> ^@	<SOH> ^A	Type Code	Sign Address	<STX> ^B	<b>Command Code</b>	<b>Data Field</b>	<EOT> ^D
-------------	-------------	-------------	-------------	-------------	-------------	--------------	-----------------	-------------	-------------------------	-----------------------	-------------

45H "E"	73H "s"	ACK/NAK Enable
<b>A</b>	<b>B</b>	<b>C</b>

Item	Name	Description
<b>A</b>	Command Code	"E" (45H) = Write SPECIAL FUNCTION file
<b>B</b>	Special Functions Label	"s" (73H) = Enable/Disable ACK/NAK response
<b>C</b>	ACK/NAK Enable	One ASCII character: "0" 30H = disable ACK/NAK sign response ( <b>default</b> ) "1" 31H = enable ACK/NAK sign response

### 7.13.9 Temperature Logging

After the temperature is read, it is compared to the previous read and the maximum and minimum temperatures are stored. The board and external temperatures (minimum and maximum) are recorded every 30 minutes over the past 24 hours.

Board temperature is in Celsius and external temperature is in Fahrenheit.

By ignoring the Alpha packet codes, you should be able to store the log as a text file.

NOTE: “-127” is returned by the firmware if there is no probe connected to the display, or when the probe connected is malfunctioning. Also, only simulating a virgin power up clears this log.

#### 7.13.9.1 Read Temperature Log command packet format

**Table 96: Read Temperature Log packet format**

Standard transmission packet (see "Standard transmission packet ("1-byte" or "AA" format" on page 10):

<code>&lt;NUL&gt;</code>	<code>&lt;NUL&gt;</code>	<code>&lt;NUL&gt;</code>	<code>&lt;NUL&gt;</code>	<code>&lt;NUL&gt;</code>	<code>&lt;SOH&gt;</code>	Type Code	Sign Address	<code>&lt;STX&gt;</code>	<b>Command Code</b>	<b>Data Field</b>	<code>&lt;EOT&gt;</code>
<code>^@</code>	<code>^@</code>	<code>^@</code>	<code>^@</code>	<code>^@</code>	<code>^A</code>			<code>^B</code>			<code>^D</code>

46H <b>"F"</b>	4CH <b>"L"</b>	<b>Special Functions Data</b>
A	B	C

Item	Name	Description
A	Command Code	"F" (46H) = Read SPECIAL FUNCTION file
B	Special Functions Label	"L" (4CH) = Read Temperature Log
C	Special Functions Data	This data is returned in the response packet (see "Read Temperature Log command example" on page 123).

7.13.9.2 Read Temperature Log command example

Table 97: Temperature Log command example

Item	Name	Value	Description
<b>A</b>	<NUL>	00H	These five <NUL>s cause a sign to lock onto a baud rate. (This is also called "autobauding".)
<b>B</b>	<SOH>	01H	Start Of Header character
<b>C</b>	Type Code	"Z"	"Z" (5AH) means that all signs should respond to this command.
<b>D</b>	Sign Address	"00"	"00" (30H 30H) means that this command is sent to all signs.
<b>E</b>	<STX>	02H	Start of TeXt character
<b>F</b>	Command Code	"F"	"F" (46H) is the "Read SPECIAL FUNCTION" Command Code. (See Table 16, "Read SPECIAL FUNCTION Command Code format — "F" (46H)," on page 29.)
<b>G</b>	Data Field Special Functions Label	"L"	Read Temperature Log register.
<b>H</b>	<EOT>	04H	End Of Transmission character

Table 98: Temperature Log command response example

Item	Name	Value	Description
<b>A</b>	<NUL>	00H	These five <NUL>s cause a sign to lock onto a baud rate. (This is also called "autobauding".)
<b>B</b>	<SOH>	01H	Start Of Header character
<b>C</b>	Type Code	"0"	"0" (30H) is the Response code.
<b>D</b>	Sign Address	"00"	"00" (30H 30H) means that this command is sent to all signs.
<b>E</b>	<STX>	02H	Start of TeXt character
<b>F</b>	Command Code	"E"	"E" (45H) is the response to the Read Temperature Log request.
<b>G</b>	Special Functions Label	"L"	Read Temperature Log register.

```

<NUL><NUL><NUL><NUL><NUL><SOH>"000"<STX>"EL"<CR><LF>
"DAILY LOG: Bm Bx Em Ex"<CR><LF>
"+27C +29C +070F +075F"<CR><LF>
"+26C +32C +074F +079F"<CR><LF>
"+28C +33C +079F +085F"<CR><LF>
.
.
"+28C +33C +079F +085F"<CR><LF>
"6-MONTH LOG: MM-DD Bm Bx Em Ex"<CR><LF>
"01-02 +028C +033C +079F +085F"<CR><LF>
"01-03 +027C +029C +070F +075F"<CR><LF>
"01-04 +021C +022C +068F +069F"<CR><LF>
.
.
"06-28 +030C +033C +098F +104F"<CR><LF>
"ERROR LOG: MM-DD HH:MM ER Bm Bx Em Ex"<CR><LF>
"01-02 11:59 1 +020C +048C +070F +079F"<CR><LF>
.
.
"05-12 01:22 3 +028C +033C +079F +099F"<CR><LF>
<ETX>"023F"<EOT>
    
```

Table 98: Temperature Log command response example

<b>H</b>		<CR><LF>	0DH 0AH	Used to format the log for readability.
<b>I</b>	Special Functions Data	Daily Log	"DAILY LOG: ..."	<p>48 entries recorded every half-hour from the previous half-hour in the following format: TITLEAAAAABBBBBCCCCDDDDDD where:</p> <ul style="list-style-type: none"> <li>TITLE = the ASCII string "DAILY LOG: Bn Bx Em Ex" which only appears once at the top of the entries.</li> <li>AAAAA = five ASCII characters that represent the Controller board <i>minimum</i> temperature: a "+" or "-", followed by a 3-digit temperature, followed by "C" for Centigrade.</li> <li>BBBBB = five ASCII characters that represent the Controller board <i>maximum</i> temperature: a "+" or "-", followed by a 3-digit temperature, followed by "C" for Centigrade.</li> <li>CCCCC = five ASCII characters that represent the sign's external <i>minimum</i> temperature: a "+" or "-", followed by a 3-digit temperature, followed by "F" for Fahrenheit.</li> <li>DDDDD = five ASCII characters that represent the sign's external <i>maximum</i> temperature: a "+" or "-", followed by a 3-digit temperature, followed by "F" for Fahrenheit.</li> </ul>
<b>J</b>		6-Month Log	"6-MONTH LOG: ..."	<p>178 entries recorded for the previous 178 days in the following format: TITLEAAAAABBBBBCCCCDDDDDEEEEE where:</p> <ul style="list-style-type: none"> <li>TITLE = the ASCII string "6-MONTH LOG: MM-DD Bn Bx Em Ex" which only appears once at the top of the entries.</li> <li>AAAAA = five ASCII characters representing the 2-digit month, a dash ("- 2DH), and the 2-digit day.</li> <li>BBBBB = five ASCII characters that represent the Controller board <i>minimum</i> temperature: a "+" or "-", followed by a 3-digit temperature, followed by "C" for Centigrade.</li> <li>CCCCC = five ASCII characters that represent the Controller board <i>maximum</i> temperature: a "+" or "-", followed by a 3-digit temperature, followed by "C" for Centigrade.</li> <li>DDDDD = five ASCII characters that represent the sign's external <i>minimum</i> temperature: a "+" or "-", followed by a 3-digit temperature, followed by "F" for Fahrenheit.</li> <li>EEEE E = five ASCII characters that represent the sign's external <i>maximum</i> temperature: a "+" or "-", followed by a 3-digit temperature, followed by "F" for Fahrenheit.</li> </ul>
<b>K</b>	Special Functions Data	Error Log	"ERROR LOG: ..."	<p>An event-driven log that records the last 48 errors which were caused by either dimming or shutdown. The error log is in the following format: TITLEAAAAABBBBBCCCCDDDDDEEEEEFFFFFGGGG</p> <ul style="list-style-type: none"> <li>TITLE = the ASCII string "ERROR LOG: MM-DD ER Bn Bx Em Ex" which only appears once at the top of the entries.</li> <li>AAAAA = five ASCII characters representing the 2-digit month, a dash ("- 2DH), and the 2-digit day.</li> <li>BBBBB = five ASCII characters representing the 2-digit hour, a colon (":" 3AH), and the 2-digit minute.</li> <li>C = one ASCII number representing the type of error, where: <ul style="list-style-type: none"> <li>"2" = Controller temperature caused overheat mode</li> <li>"5" = Controller caused dimming mode</li> <li>"6" = external temperature caused dimming mode</li> </ul> </li> <li>DDDDD = five ASCII characters that represent the Controller board <i>minimum</i> temperature: a "+" or "-", followed by a 3-digit temperature, followed by "C" for Centigrade.</li> <li>EEEE E = five ASCII characters that represent the Controller board <i>maximum</i> temperature: a "+" or "-", followed by a 3-digit temperature, followed by "C" for Centigrade.</li> <li>FFFF F = five ASCII characters that represent the sign's external <i>minimum</i> temperature: a "+" or "-", followed by a 3-digit temperature, followed by "F" for Fahrenheit.</li> <li>GGGGG = five ASCII characters that represent the sign's external <i>maximum</i> temperature: a "+" or "-", followed by a 3-digit temperature, followed by "F" for Fahrenheit.</li> </ul>
<b>L</b>		<ETX>	03H	End of TeXt character
<b>M</b>		Checksum	"023F"	Four ASCII digits that represent a 16-bit hexadecimal summation of all transmitted data from the previous <STX> through the previous <ETX> inclusive. The most significant digit is first.
<b>N</b>		<EOT>	04H	End Of Transmission character

### 7.13.10 Read External Temperature command

NOTE: The packet format of this command is similar to “Read Temperature Log command example” on page 123.

“T” — Sending “FT” will read the external temperature provided there is a functioning external temperature probe connected to the controller being queried.

If there is no probe connected or if it is not functioning properly, the sign will return “-127” for the temperature value (in Fahrenheit). In addition, “ERR” will appear on the sign in place of the temperature.

#### 7.13.10.1 Read External Temperature command packet format

**Table 99: Read External Temperature command packet format**

Standard transmission packet (see “Standard transmission packet (“1-byte” or “AA”) format” on page 10):

<NUL> ^@	<NUL> ^@	<NUL> ^@	<NUL> ^@	<NUL> ^@	<SOH> ^A	Type Code	Sign Address	<STX> ^B	<b>Command Code</b>	<b>Data Field</b>	<EOT> ^D
-------------	-------------	-------------	-------------	-------------	-------------	--------------	-----------------	-------------	-------------------------	-----------------------	-------------

46H "F"	54H "T"	<b>Special Functions Data</b>
A	B	C

Item	Name	Description
A	Command Code	"F" (46H) = Write SPECIAL FUNCTION file
B	Special Functions Label	"T" (54H) = Read External Temperature.
C	Special Functions Data	This data is returned in the response packet (see “Read Temperature Log command example” on page 123).

#### 7.13.10.2 Read External Temperature command example

**Table 100: Read External Temperature command example**

<NUL><NUL><NUL><NUL><NUL><SOH>"Z00"<STX>"FT"<EOT>

A	B	C	D	E	F	G	H
---	---	---	---	---	---	---	---

Item	Name	Value	Description
A	<NUL>	00H	These five <NUL>s cause a sign to lock onto a baud rate. (This is also called “autobauding”.)
B	<SOH>	01H	Start Of Header character
C	Type Code	"Z"	"Z" (5AH) means that all signs should respond to this command.
D	Sign Address	"00"	"00" (30H 30H) means that this command is sent to all signs.
E	<STX>	02H	Start of TeXt character
F	Command Code	"F"	"F" (46H) is the “Read SPECIAL FUNCTION” Command Code. (See Table 16, “Read SPECIAL FUNCTION Command Code format — “F” (46H),” on page 29.)
G	Data Field	Special Functions Label	"T"
H	<EOT>	04H	End Of Transmission character

**Table 101: Read External Temperature command response example**

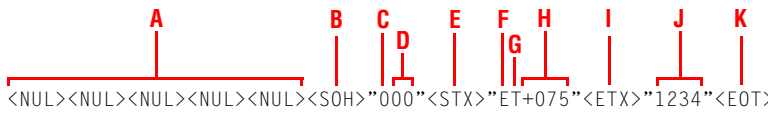

Item	Name	Value	Description
A	<NUL>	00H	These five <NUL>s cause a sign to lock onto a baud rate. (This is also called "autobauding".)
B	<SOH>	01H	Start Of Header character
C	Type Code	"0"	"0" (30H) is the Response code.
D	Sign Address	"00"	"00" (30H 30H) means that this command is sent to all signs.
E	<STX>	02H	Start of TeXt character
F	Command Code	"E"	"E" (45H) is the response to the Read External Temperature command.
G	Special Functions Label	"T"	Read External Temperature command.
H	Data Field	"+075"	The external temperature in degrees Fahrenheit.
I	<ETX>	03H	End of TeXt character
J	Checksum	"023F"	Four ASCII digits that represent a 16-bit hexadecimal summation of all transmitted data from the previous <STX> through the previous <ETX> inclusive. The most significant digit is first.
K	<EOT>	04H	End Of Transmission character

**7.13.11 Read Internal Temperature command**

"TI" — Sending "FTI" will read the internal temperature.

NOTE: The format of this command is similar to "Read Temperature Log command example" on page 123.

**7.13.11.1 Read Internal Temperature command packet format**

**Table 102: Read Internal Temperature command packet format**

Standard transmission packet (see "Standard transmission packet ("1-byte" or "AA") format" on page 10):

<NUL> ^@	<NUL> ^@	<NUL> ^@	<NUL> ^@	<NUL> ^@	<SOH> ^A	Type Code	Sign Address	<STX> ^B	Command Code	Data Field	<EOT> ^D
-------------	-------------	-------------	-------------	-------------	-------------	-----------	--------------	-------------	--------------	------------	-------------

46H "F"	54H + 49H "TI"	Special Functions Data
------------	-------------------	------------------------

A                  B                  C

Item	Name	Description
A	Command Code	"F" (46H) = Write SPECIAL FUNCTION file
B	Special Functions Label	"TI" (54H + 49H) = Read Internal Temperature.
C	Special Functions Data	This data is returned in the response packet (see "Read Temperature Log command example" on page 123).

7.13.11.2 Read Internal Temperature command example

Table 103: Read Internal Temperature command example

Item	Name	Value	Description
<b>A</b>	<NUL>	00H	These five <NUL>s cause a sign to lock onto a baud rate. (This is also called "autobauding".)
<b>B</b>	<SOH>	01H	Start Of Header character
<b>C</b>	Type Code	"Z"	"Z" (5AH) means that all signs should respond to this command.
<b>D</b>	Sign Address	"00"	"00" (30H 30H) means that this command is sent to all signs.
<b>E</b>	<STX>	02H	Start of TeXt character
<b>F</b>	Command Code	"F"	"F" (46H) is the "Read SPECIAL FUNCTION" Command Code. (See Table 16, "Read SPECIAL FUNCTION Command Code format — "F" (46H)," on page 29.)
<b>G</b>	Data Field	Special Functions Label	"Tl"
<b>H</b>	<EOT>	04H	End Of Transmission character

Table 104: Read Internal Temperature command response example

Item	Name	Value	Description
<b>A</b>	<NUL>	00H	These five <NUL>s cause a sign to lock onto a baud rate. (This is also called "autobauding".)
<b>B</b>	<SOH>	01H	Start Of Header character
<b>C</b>	Type Code	"0"	"0" (30H) is the response code.
<b>D</b>	Sign Address	"00"	"00" (30H 30H) means that this command is sent to all signs.
<b>E</b>	<STX>	02H	Start of TeXt character
<b>F</b>	Command Code	"E"	"E" (45H) is the response to the Read Internal Temperature command.
<b>G</b>	Special Functions Label	"Tl"	Read Internal Temperature command.
<b>H</b>	Data Field	" +020C"	The internal temperature in degrees Centigrade.
<b>I</b>	<ETX>	03H	End of TeXt character
<b>J</b>	Checksum	"023F"	Four ASCII digits that represent a 16-bit hexadecimal summation of all transmitted data from the previous <STX> through the previous <ETX> inclusive. The most significant digit is first.
<b>K</b>	<EOT>	04H	End Of Transmission character

### 7.13.12 Set Unit commands

These commands are used to set sign parameters, such as the serial address. Once a sign receives a Set Unit command, the sign will reset and go through its power-up messages.

**SPECIAL NOTE**  
Set Unit commands are only available in AlphaEclipse 2500, 2600, 3500 Series B, 3600 and RoadStar signs.

Further changes to sign parameters can then only be made through a Set Unit command — unless the “UN” command is sent to the sign.

When the “UN” command is sent to a sign, the sign will use its DIP switch settings.

Sending a clear memory command (“E\$”), a soft reset command (“E,”), or updating the firmware will have no affect on a sign’s parameters.

Multiple write Set Unit commands can be combined in a packet, for example:

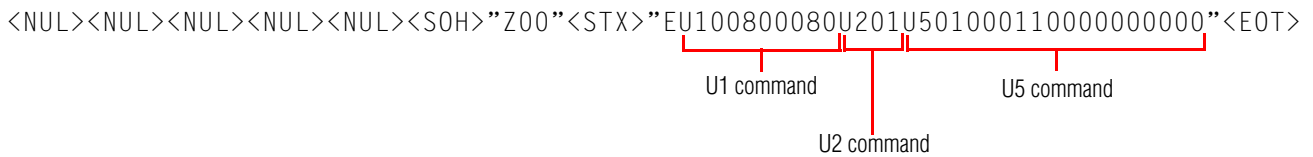

**Table 105: Set Unit commands packet format**

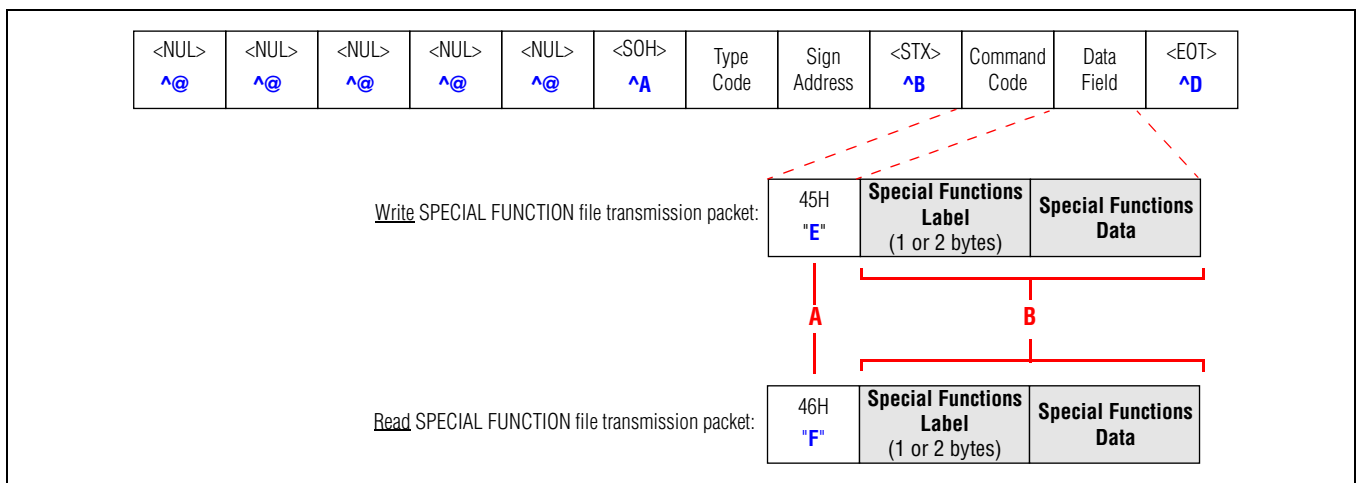

Special Functions Label (2 bytes)	Special Functions Data Command Code "E" (45H) sets sign parameters. Command Code "F" (46H) reads sign parameters.
"U1"    55H 31H	<p><b>Set/Read Unit Size</b> (write or read) — sets or reads the sign’s columns and rows. Eight ASCII hexadecimal digits in the format AAAABBBB where:</p> <ul style="list-style-type: none"> <li>• AAAA = Column size of the sign (valid values = 0010 – 00F0 columns)</li> <li>• BBBB = Row size of the sign (valid values = 0008 – 0080 rows)</li> </ul>
"U2"    55H 32H	<p><b>Set/Read Unit Run Mode</b> (write or read) — sets or reads the mode that the sign is running. Two ASCII hexadecimal digits where:</p> <ul style="list-style-type: none"> <li>• "00" 30H + 30H = Run normally (<b>default</b>)</li> <li>• "01" 30H + 31H = Test 1 (production test mode)</li> <li>• "02" 30H + 32H = Test 2 (burn-in test pattern)</li> <li>• "03" 30H + 33H = Test 3 (test match mode)</li> <li>• "04" 30H + 34H = Test 4 (temperature test mode)</li> <li>• "05" 30H + 35H = Test 5 (test grid)</li> <li>• "06" 30H + 36H = Test 6 (test cluster)</li> <li>• "07" — "FF" = Future Use</li> </ul>
"U3"    55H 33H	<p><b>Set/Read Unit Serial Address</b> (write or read) — sets or reads the sign’s serial address. Two ASCII hexadecimal digits from 0 to 255 in the following format:</p> <ul style="list-style-type: none"> <li>• "00" 30H + 30H to "FF" 46H + 46H</li> </ul>



**Table 105: Set Unit commands packet format**

<p>"U4" 55H 34H</p>	<p><b>Set/Read Unit Serial Data</b> (write or read) — sets or reads the sign's baud rate and data format. Two ASCII hexadecimal digits from 0 to 12 in the following format:</p> <p>NOTE: Note that this command will reset the baud rate. Your next packet must be at that baud rate. You cannot use this command packet in a nested transmission.</p> <ul style="list-style-type: none"> <li>• "00" 30H + 30H = Autobaud from 38400 baud (8N1/7E2 data format)</li> <li>• "01" 30H + 31H = 1200 baud (8N1 data format)</li> <li>• "02" 30H + 32H = 1200 baud (7E2 data format)</li> <li>• "03" 30H + 33H = 2400 baud (8N1 data format)</li> <li>• "04" 30H + 34H = 2400 baud (7E2 data format)</li> <li>• "05" 30H + 35H = 4800 baud (8N1 data format)</li> <li>• "06" 30H + 36H = 4800 baud (7E2 data format)</li> <li>• "07" 30H + 37H = 9600 baud (8N1 data format)</li> <li>• "08" 30H + 38H = 9600 baud (7E2 data format)</li> <li>• "09" 30H + 39H = 19200 baud (8N1 data format)</li> <li>• "0A" 30H + 3AH = 19200 baud (7E2 data format)</li> <li>• "0B" 30H + 34B = 38400 baud (8N1 data format)</li> <li>• "0C" 30H + 3CH = 38400 baud (7E2 data format)</li> </ul> <p>When a sign is configured for autobaud, every packet sent to the display must be preceded by at least five &lt;NUL&gt; or &lt;SOH&gt; characters in order for the firmware to be able to calculate the baud rate of the transmission.</p>
<p>"U5" 55H 35H</p>	<p><b>Set/Read Unit Configuration</b> (write or read) — sets or reads various sign parameters. Seventeen ASCII characters in the format FGH IJKLZZZZZZZZZZ where:</p> <ul style="list-style-type: none"> <li>• F = Clear memory flag <ul style="list-style-type: none"> <li>• "0" 30H — Do not clear memory on power-up</li> <li>• "1" 31H — Clear memory on power-up (simulates a virgin power-up, the first time power is applied to a sign)</li> </ul> </li> <li>• G = Master/Slave flag <ul style="list-style-type: none"> <li>• "0" 30H — Master sign</li> <li>• "1" 31H — Slave sign</li> <li>• "2" 32H — Secondary Master sign</li> </ul> </li> <li>• H = Demo message flag (not applicable for AlphaEclipse signs, but a value must be used as a place holder.) <ul style="list-style-type: none"> <li>• "0" 30H — Off</li> <li>• "1" 31H — On</li> </ul> </li> <li>• I = Color flag (not applicable for AlphaEclipse signs, but a value must be used as a place holder.) <ul style="list-style-type: none"> <li>• "0" 30H — Mono</li> <li>• "1" 31H — Color unit</li> </ul> </li> <li>• J = IR flag (not applicable for AlphaEclipse signs, but a value must be used as a place holder.) <ul style="list-style-type: none"> <li>• "0" 30H — IR off</li> <li>• "1" 31H — IR on</li> </ul> </li> <li>• K = RS485 echo flag (not applicable for AlphaEclipse signs, but a value must be used as a place holder) <ul style="list-style-type: none"> <li>• "0" 30H — Off</li> <li>• "1" 31H — On</li> </ul> </li> <li>• L = Driver height <ul style="list-style-type: none"> <li>• "0" 30H — 8 High</li> <li>• "1" 31H — 16 High</li> </ul> </li> <li>• ZZZZZZZZZZ — Ten ASCII characters. For future use. Send "0" (30H) if not used. (not applicable for AlphaEclipse<sup>™</sup> signs, but a value must be used as a place holder.) For further definition of these bytes, see <b>Table 110 on page 134</b>.</li> </ul>
<p>"U6" 55H 36H</p>	<p><b>Read Unit Register</b> (read only) — reads the sign's DIP switches and memory (RAM). Twelve ASCII hexadecimal digits in the format AABBCDDXXXX where:</p> <ul style="list-style-type: none"> <li>• AA = DIP switch bank 1 value</li> <li>• BB = DIP switch bank 2 value</li> <li>• CC = DIP switch bank 3 value</li> <li>• DD = DIP switch bank 4 value</li> <li>• XXXX = total amount of RAM in kilobytes (for example, "03E8" = 1000 decimal = 1000 kilobytes = 1 megabyte)</li> </ul>
<p>"UN" 55H 4EH</p>	<p><b>Reset command</b> (write only) — for an AlphaEclipse 2500, 2600, and 3500, this command resets all parameters to the values set on the sign's DIP switches. After receiving this command, a sign will use its DIP switch settings for parameter values. For an AlphaEclipse 3600 or RoadStar sign, the sign is reset to its default factory settings and custom user configurations are erased.</p>

### 7.13.13 Read Dim Times command

This Read SPECIAL FUNCTION command returns the sign’s dim on and off times encoded in a four-byte, ASCII hexadecimal code. For the meaning of these codes, see “Appendix B: Valid Start and Stop times” on page 51.

#### 7.13.13.1 Read Dim Times command packet format

Table 106: Read Dim Times command packet format

<NUL> ^@	<NUL> ^@	<NUL> ^@	<NUL> ^@	<NUL> ^@	<SOH> ^A	Type Code	Sign Address	<STX> ^B	Command Code	Data Field	<EOT> ^D
-------------	-------------	-------------	-------------	-------------	-------------	--------------	-----------------	-------------	-----------------	---------------	-------------

45H "F"	2FH "/"	Special Functions Data
------------	------------	---------------------------

A      B      C

Special Functions Label	Special Functions Data
	Command Code "F" (46H) reads sign parameters.
A	Command Code "F" (46H) = Read SPECIAL FUNCTION command
B	Special Functions Label "/" (2FH) = Read Dim Times
C	Special Functions Data This data is returned in the response packet (see Table 108, "Read Dim Times command response example," on page 130).

#### 7.13.13.2 Read Dim Times command example

Table 107: Read Dim Times command example

<NUL><NUL><NUL><NUL><NUL><SOH>"Z00"<STX>"F/"<EOT> 			
---	--	--	--

Item	Name	Value	Description
A	<NUL>	00H	These five <NUL>s cause a sign to lock onto a baud rate. (This is also called "autobauding".)
B	<SOH>	01H	Start Of Header character
C	Type Code	"Z"	"Z" (5AH) means that all signs should respond to this command.
D	Sign Address	"00"	"00" (30H 30H) means that this command is sent to all signs.
E	<STX>	02H	Start of TeXt character
F	Command Code	"F"	"F" (46H) is the "Read SPECIAL FUNCTION" Command Code. (See Table 16, "Read SPECIAL FUNCTION Command Code format — "F" (46H)," on page 29.)
G	Data Field	Special Functions Label "/"	Read Dim Times command.
H	<EOT>	04H	End Of Transmission character

Table 108: Read Dim Times command response example

<NUL><NUL><NUL><NUL><NUL><SOH>"000"<STX>"E/7824"<EOT> 			
---	--	--	--

Item	Name	Value	Description
A	<NUL>	00H	These five <NUL>s cause a sign to lock onto a baud rate. (This is also called "autobauding".)

**Table 108: Read Dim Times command response example**

<b>B</b>	<SOH>	01H	Start Of Header character
<b>C</b>	Type Code	"0"	"0" (30H) is the Response code.
<b>D</b>	Sign Address	"00"	"00" (30H 30H) means that this command is sent to all signs.
<b>E</b>	<STX>	02H	Start of TeXt character
<b>F</b>	Command Code	"E"	"E" (45H) is the response to a Read SPECIAL FUNCTION command.
<b>G</b>	Special Functions Label	"/"	Read Dim Times
<b>H</b>	Data Field	"7824"	<p>Four, encoded ASCII hexadecimal characters that represent the dim on and dim off times. In this case,</p> <ul style="list-style-type: none"> <li>• "78" = a dim on time of 8:00 pm</li> <li>• "24" = a dim off time of 6:00 am</li> </ul> <p>For a list of these encoded times, see "Appendix B: Valid Start and Stop times" on page 51.</p>
<b>I</b>	<EOT>	04H	End Of Transmission character

## 7.14 Appendix N: Alpha 3.0 protocol additions

NOTE: As of the writing of this protocol manual, the Alpha 3.0 protocol is only available for AlphaEclipse 3600, RoadStar, and StreetSmart signs.

The Alpha 3.0 protocol adds the following functions to the existing Alpha 1.0 and Alpha 2.0 protocols:

**Table 109: Alpha 3.0 protocol additions**

Function	Type	Description	Reference
Set Unit Commands	Write/Read SPECIAL FUNCTION "U5", "U6", "U7", "U8", "U9", "UA", "UB", "UI", "UL", "UJ", "Us", and "Ug"	A series of commands that allows setting and reading sign parameters such as serial address.	"Additions to Set Unit commands" on page 134
Read Over Temp Flag	Read SPECIAL FUNCTION "T" [54H]	Read whether the sign is in overheat mode or standard operations.	"Read Over-Temp Flag Command" on page 137
Read Compact Flash Status	Read SPECIAL FUNCTION "F" [46H]	Read compact flash status.	"Read Compact Flash Status Command" on page 137
Read/Clear Message Tracking	Read SPECIAL FUNCTION "K" [4BH]	Read/clear message tracking.	"Read Message Tracking Command" on page 138 and "Clear Message Time Tracking Command" on page 138
Turn ON/OFF Periodic Sampling	Write/Read SPECIAL FUNCTION "P" [50H]	Turn off sampling of light sensor and temperature probe.	"Turn ON/OFF Periodic Sampling Command" on page 138
RGB Set Color in Text Attribute	Text Attributes	Sets the color of the text being displayed.	"RGB Set Color in Text Attribute" on page 139
RGB protocol	GIF Attributes	RGB protocol.	"RGB GIF protocol (RGB Dot Additions)" on page 139
Write/Read Serial Number	Write/Read SPECIAL FUNCTION "A" [41H]	Write/Read serial number.	"Write/Read Serial Number" on page 140
Explode Mode	Standard Mode "u" [75H]	Text "explodes" into four pieces and directions.	Table 65, "Standard Modes," on page 89
Clock Mode	Standard Mode "v" [76H]	A clockwise text wipe	Table 65, "Standard Modes," on page 89
Left/Right Display Position	Text file Left Display Position "1" [31H] Text file Right Display Position "2" [32H]	These two new positions work like the Top and Bottom positions, but for the left and right parts of the display.	Table 12, "Write TEXT file transmission packet format," on page 18
Faster Flicks	Control Code for Call picture or animation file	Faster Flicks can be displayed in 0.01 second increments instead of 0.1.	"Control codes (00 – 1FH)" on page 81.

**Table 109: Alpha 3.0 protocol additions**

Function	Type	Description	Reference
Color functions	<ul style="list-style-type: none"> <li>• Character color — Control Code for Character Color &lt;1CH&gt;"Z"</li> <li>• Shadow color — Control Code for Character Color &lt;1CH&gt;"Y"</li> <li>• Write SPECIAL FUNCTION Special Functions Label "8" 38H Memory Configuration for an RGB DOTS PICTURE</li> <li>• Write RGB DOTS PICTURE Command Code "K" [4BH]</li> <li>• Read RGB DOTS PICTURE Command Code "L" [4CH]</li> <li>• Call RGB DOTS PICTURE Control Code &lt;1FH&gt;</li> <li>• Write/Read SPECIAL FUNCTION Special Functions Label "C" 43H Color Correction command for an RGB or mono-color AlphaEclipse 3600 sign.</li> </ul>	<ul style="list-style-type: none"> <li>• RGB (Red-Green-Blue) character color coding added which permits over 16 million (256 x 256 x 256) color combinations.</li> <li>• RGB (Red-Green-Blue) character shadow color coding added which permits over 16 million (256 x 256 x 256) color combinations.</li> <li>• Used to set up sign memory for an RGB LARGE DOTS PICTURE.</li> <li>• Used to create an RGB DOTS PICTURE file in a sign.</li> <li>• Use to read an RGB DOTS PICTURE file from a sign</li> <li>• Used to display an RGB DOTS PICTURE on a sign.</li> <li>• Use Write to turn RGB or red gamma color correction on or off. Red gamma correction is used for mono-color (red or amber) signs. Use Read to find out if color correction is on or off.</li> </ul>	<ul style="list-style-type: none"> <li>• "Control codes (00 – 1FH)" on page 81.</li> <li>• "Control codes (00 – 1FH)" on page 81.</li> <li>• See the Special Functions Label "8" in Table 15, "Write SPECIAL FUNCTION Command Code format — "E" (45H)," on page 21.</li> <li>• See "Write RGB DOTS PICTURE file Command Code — "K" (4BH)" on page 44.</li> <li>• See "Read RGB DOTS PICTURE file Command Code — "L" (4CH)" on page 46.</li> <li>• See "Control codes (00 – 1FH)" on page 81.</li> <li>• See the Special Functions Label "C" in Table 15, "Write SPECIAL FUNCTION Command Code format — "E" (45H)," on page 21 and in Table 16, "Read SPECIAL FUNCTION Command Code format — "F" (46H)," on page 29.</li> </ul>
Read Firmware Revisions	Read SPECIAL FUNCTION Special Functions Label "v" [76H]	Used to read the firmware and FPGA versions.	See "v" in Table 16, "Read SPECIAL FUNCTION Command Code format — "F" (46H)," on page 29.

### 7.14.1 Additions to Set Unit commands

For more information, see “Set Unit commands” on page 128

**Table 110: Additions to Set Unit commands**

<NUL> ^@	<NUL> ^@	<NUL> ^@	<NUL> ^@	<NUL> ^@	<SOH> ^A	Type Code	Sign Address	<STX> ^B	Command Code	Data Field	<EOT> ^D
-------------	-------------	-------------	-------------	-------------	-------------	--------------	-----------------	-------------	-----------------	---------------	-------------

Write SPECIAL FUNCTION file transmission packet:

45H "E"	<b>Special Functions Label</b> (1 or 2 bytes)	<b>Special Functions Data</b>
------------	--	-------------------------------

A

Read SPECIAL FUNCTION file transmission packet:

46H "F"	<b>Special Functions Label</b> (1 or 2 bytes)	<b>Special Functions Data</b>
------------	--	-------------------------------

B

Special Functions Label (2 Bytes)	Special Functions Data																																												
	Command Code "E" (45H) sets sign parameters. Command Code "F" (46H) reads sign parameters.																																												
"U5"    55H 35H	<p><b>Set Unit Configuration Flag Defaults</b>                      "EU5FGHIJKLZ<sub>0</sub>Z<sub>1</sub>Z<sub>2</sub>Z<sub>3</sub>Z<sub>4</sub>Z<sub>5</sub>Z<sub>6</sub>Z<sub>7</sub>Z<sub>8</sub>Z<sub>9</sub>" — command                      Register Data (<b>X = not applicable, but a value must be used as a place holder</b>):</p> <table border="1" style="width: 100%; border-collapse: collapse;"> <thead> <tr> <th style="width: 50%;">Data</th> <th style="width: 16.6%;">AlphaEclipse 3600 Default Settings</th> <th style="width: 16.6%;">AlphaEclipse RoadStar Default Settings</th> <th style="width: 16.6%;">AlphaEclipse StreetSmart Default Settings</th> </tr> </thead> <tbody> <tr> <td> <b>F — Clear Memory Flag</b>                              "0" [30H] — Don't clear memory on power up                              "1" [31H] — Clear memory on power up                         </td> <td style="text-align: center;">0</td> <td style="text-align: center;">0</td> <td style="text-align: center;">0</td> </tr> <tr> <td> <b>G — Master/Slave Flag</b>                              "0" [30H] — Master                              "1" [31H] — Slave                              "2" [32H] — Secondary Master                         </td> <td style="text-align: center;">0</td> <td style="text-align: center;">0</td> <td style="text-align: center;">0</td> </tr> <tr> <td> <b>H — Demo Message Flag</b>                              "0" [30H] — Off                              "1" [31H] — On                         </td> <td style="text-align: center;">1</td> <td style="text-align: center;">1</td> <td style="text-align: center;">1</td> </tr> <tr> <td> <b>I — Color Flag</b>                              "0" [30H] — Mono                              "1" [31H] — Color                         </td> <td style="text-align: center;">X</td> <td style="text-align: center;">X</td> <td style="text-align: center;">X</td> </tr> <tr> <td> <b>J — IR Flag</b>                              "0" [30H] — IR off                              "1" [31H] — IR on                         </td> <td style="text-align: center;">X</td> <td style="text-align: center;">X</td> <td style="text-align: center;">X</td> </tr> <tr> <td> <b>K — RS485 Echo</b>                              "0" [30H] — Off                              "1" [31H] — On                         </td> <td style="text-align: center;">X</td> <td style="text-align: center;">X</td> <td style="text-align: center;">X</td> </tr> <tr> <td> <b>L — Driver Height</b>                              "0" [30H] — 8 High drivers                              "1" [31H] — 16 High drivers                         </td> <td style="text-align: center;">1</td> <td style="text-align: center;">0</td> <td style="text-align: center;">0</td> </tr> <tr> <td> <b>Z<sub>0</sub> — Dimming register ON/OFF</b>                              "0" [30H] — Off                              "1" [31H] — On                         </td> <td style="text-align: center;">X</td> <td style="text-align: center;">0</td> <td style="text-align: center;">0</td> </tr> <tr> <td> <b>Z<sub>1</sub> — Dimming register setting high register</b>                              0H — FH                         </td> <td style="text-align: center;">X</td> <td style="text-align: center;">0</td> <td style="text-align: center;">0</td> </tr> <tr> <td> <b>Z<sub>2</sub> — Dimming register setting low register</b>                              0H — FH                         </td> <td style="text-align: center;">X</td> <td style="text-align: center;">0</td> <td style="text-align: center;">0</td> </tr> </tbody> </table>	Data	AlphaEclipse 3600 Default Settings	AlphaEclipse RoadStar Default Settings	AlphaEclipse StreetSmart Default Settings	<b>F — Clear Memory Flag</b> "0" [30H] — Don't clear memory on power up "1" [31H] — Clear memory on power up	0	0	0	<b>G — Master/Slave Flag</b> "0" [30H] — Master "1" [31H] — Slave "2" [32H] — Secondary Master	0	0	0	<b>H — Demo Message Flag</b> "0" [30H] — Off "1" [31H] — On	1	1	1	<b>I — Color Flag</b> "0" [30H] — Mono "1" [31H] — Color	X	X	X	<b>J — IR Flag</b> "0" [30H] — IR off "1" [31H] — IR on	X	X	X	<b>K — RS485 Echo</b> "0" [30H] — Off "1" [31H] — On	X	X	X	<b>L — Driver Height</b> "0" [30H] — 8 High drivers "1" [31H] — 16 High drivers	1	0	0	<b>Z<sub>0</sub> — Dimming register ON/OFF</b> "0" [30H] — Off "1" [31H] — On	X	0	0	<b>Z<sub>1</sub> — Dimming register setting high register</b> 0H — FH	X	0	0	<b>Z<sub>2</sub> — Dimming register setting low register</b> 0H — FH	X	0	0
	Data	AlphaEclipse 3600 Default Settings	AlphaEclipse RoadStar Default Settings	AlphaEclipse StreetSmart Default Settings																																									
	<b>F — Clear Memory Flag</b> "0" [30H] — Don't clear memory on power up "1" [31H] — Clear memory on power up	0	0	0																																									
	<b>G — Master/Slave Flag</b> "0" [30H] — Master "1" [31H] — Slave "2" [32H] — Secondary Master	0	0	0																																									
	<b>H — Demo Message Flag</b> "0" [30H] — Off "1" [31H] — On	1	1	1																																									
	<b>I — Color Flag</b> "0" [30H] — Mono "1" [31H] — Color	X	X	X																																									
	<b>J — IR Flag</b> "0" [30H] — IR off "1" [31H] — IR on	X	X	X																																									
	<b>K — RS485 Echo</b> "0" [30H] — Off "1" [31H] — On	X	X	X																																									
	<b>L — Driver Height</b> "0" [30H] — 8 High drivers "1" [31H] — 16 High drivers	1	0	0																																									
	<b>Z<sub>0</sub> — Dimming register ON/OFF</b> "0" [30H] — Off "1" [31H] — On	X	0	0																																									
	<b>Z<sub>1</sub> — Dimming register setting high register</b> 0H — FH	X	0	0																																									
	<b>Z<sub>2</sub> — Dimming register setting low register</b> 0H — FH	X	0	0																																									

**Table 110: Additions to Set Unit commands**

"U5" 55H 35H (continued)	<b>Z<sub>3</sub> — Software Simulator Synch. Flag</b> "0" [30H] — Synch. mode off Greater than 0 — Synch. mode on	0	0	0																									
	<b>Z<sub>4</sub> — Idle Mode (Unit Idle Mode Off Flag)</b> "0" [30H] — Idle mode off "1" [31H] — Idle mode on	0	0	0																									
	<b>Z<sub>5</sub> — Programmable light sensor dim flag</b> "0" [30H] — Off "1" [31H] — On	0	0	0																									
	<b>Z<sub>6</sub> — Programmable light sensor dim setting, byte 4 (0H - FH)</b>	0	0	0																									
	<b>Z<sub>7</sub> — Programmable light sensor dim setting, byte 3 (0H - FH)</b>	0	0	0																									
	<b>Z<sub>8</sub> — Programmable light sensor dim setting, byte 2 (0H - FH)</b>	0	0	0																									
	<b>Z<sub>9</sub> — Programmable light sensor dim setting, byte 1 (0H - FH)</b>	0	0	0																									
"U7" and "U9"	<p><b>Pass through commands</b>                      "EUXXXXXX" — see Analysis of Protocol below for command specifications.                      The "U7" and "U9" commands are used to pass serial protocol to the internal network of the 3600 and RoadStar signs. Devices such as temperature probes, light sensors, or driver boards are the recipients. See "Appendix K: Pass Through Command Examples" on page 101 for more information.</p>																												
"U7" 55H 37H	<p>Allows access to the unit's internal network; and wait for a response.</p> <p>There is a 3 second timeout for the peripheral device response back for request commands such as read register ("F") commands. Because it may take this long for the peripheral device to respond, there is a 1.5 second delay for non-read back commands between each message packet. For example, some peripheral devices may send back an ACK or NAK.</p>	<table border="1"> <thead> <tr> <th colspan="2">Analysis of Protocol (breakdown of code)</th> </tr> </thead> <tbody> <tr> <td><b>Command Code</b></td> <td>'E' [45H] — Write Register</td> </tr> <tr> <td><b>Register</b></td> <td>'U' [55H] — Set unit register</td> </tr> <tr> <td rowspan="2"><b>Sub-Command Code</b></td> <td>'7' [37H] — Pass through command with response</td> </tr> <tr> <td>'9' [39H] — Pass through command without response</td> </tr> <tr> <td><b>Typecode</b></td> <td>AMS typecode of connecting device</td> </tr> <tr> <td><b>Device Address</b></td> <td>XX - two byte HEX address of connecting device</td> </tr> <tr> <td><b>Turbo Channel TT</b> (Optional — special case for writing to turbo adaptor board and display board)</td> <td>Two byte HEX turbo channel number.  Reference the turbo adapter document for channel numbers.</td> </tr> <tr> <td rowspan="4"><b>EZ Data</b></td> <td colspan="2">Alpha protocol message</td> </tr> <tr> <td rowspan="2">Command Code</td> <td>'E' [45H] — Write Register</td> </tr> <tr> <td>'F' [46H] — Read Register</td> </tr> <tr> <td>Register</td> <td>The Register</td> </tr> <tr> <td>Data</td> <td>Data which depends upon command and subcommand</td> </tr> </tbody> </table>			Analysis of Protocol (breakdown of code)		<b>Command Code</b>	'E' [45H] — Write Register	<b>Register</b>	'U' [55H] — Set unit register	<b>Sub-Command Code</b>	'7' [37H] — Pass through command with response	'9' [39H] — Pass through command without response	<b>Typecode</b>	AMS typecode of connecting device	<b>Device Address</b>	XX - two byte HEX address of connecting device	<b>Turbo Channel TT</b> (Optional — special case for writing to turbo adaptor board and display board)	Two byte HEX turbo channel number.  Reference the turbo adapter document for channel numbers.	<b>EZ Data</b>	Alpha protocol message		Command Code	'E' [45H] — Write Register	'F' [46H] — Read Register	Register	The Register	Data	Data which depends upon command and subcommand
Analysis of Protocol (breakdown of code)																													
<b>Command Code</b>	'E' [45H] — Write Register																												
<b>Register</b>	'U' [55H] — Set unit register																												
<b>Sub-Command Code</b>	'7' [37H] — Pass through command with response																												
	'9' [39H] — Pass through command without response																												
<b>Typecode</b>	AMS typecode of connecting device																												
<b>Device Address</b>	XX - two byte HEX address of connecting device																												
<b>Turbo Channel TT</b> (Optional — special case for writing to turbo adaptor board and display board)	Two byte HEX turbo channel number.  Reference the turbo adapter document for channel numbers.																												
<b>EZ Data</b>	Alpha protocol message																												
	Command Code	'E' [45H] — Write Register																											
		'F' [46H] — Read Register																											
	Register	The Register																											
Data	Data which depends upon command and subcommand																												
"U9" 55H 39H	<p>Same as "U7," except no response from connecting device is received. This is used for setting devices.</p>																												
"U8" 55H 38H	<p><b>Trigger Slave Message</b> — triggers a Slave message. Only a slave device can accept this message.                      "EU8A" — command where <b>A</b> is the file name, one valid file label character for standard Alpha files (for example, "EU8A" triggers message "A"). See "Appendix A: Valid File Labels" on page 50 for a list of valid file labels.</p>																												

Table 110: Additions to Set Unit commands

"UA" 55H 41H	<p><b>Set Unit Type</b> — sets the unit into a Master, Slave, or Secondary Master.  <b>"EUAX"</b> — command where X is the unit type ("0," "1," or "2").  "0" [30H] — Master  "1" [31H] — Slave  "2" [32H] — Secondary Master</p> <p><b>Master</b> — a unit that queries the internal peripheral device network and triggers messages to the slave units.  <b>Slave</b> — a unit that listens to the internal peripheral device network and runs messages when triggered by the master.  <b>Secondary Master</b> — a unit that listens only to the internal peripheral device network and runs its own messages.</p>	
"UB" 55H 42H	<p><b>Read/Write Dimming Register (RoadStar ONLY)</b> — The Z<sub>0</sub>Z<sub>1</sub>Z<sub>2</sub>Z<sub>3</sub>Z<sub>4</sub>Z<sub>5</sub>Z<sub>6</sub>Z<sub>7</sub>Z<sub>8</sub>Z<sub>9</sub> data field of the "U5" command is used for this dimming function. If the "U5" command is set, the sign will always dim to this value (00 is equivalent to 00% on and 255 is equivalent to 100% on). The "U5" command causes the unit to reset.</p> <p>Set Unit Dimming "EUBZ<sub>0</sub>Z<sub>1</sub>Z<sub>2</sub>" will set Z<sub>0</sub>Z<sub>1</sub>Z<sub>2</sub> without resetting the sign.</p> <p>"EUBZ<sub>0</sub>Z<sub>1</sub>Z<sub>2</sub>" — command.  Z<sub>0</sub> — ON/OFF Flag (0 - "ON," 1 - "OFF").  Z<sub>1</sub> — HEX ASCII dim value high bit ("0" - "F")  Z<sub>2</sub> — HEX ASCII dim value low bit ("0" - "F")</p> <p>Read Z<sub>0</sub>Z<sub>1</sub>Z<sub>2</sub> using the "FUB" command.</p>	
"UI" 55H 49H	<p><b>Set Idle command</b>  <b>"EUIX"</b> where X equals the idle off flag (either "1" or "0").  "0" [30H] — Idle on  "1" [31H] — Idle off</p> <p>The unit default is idle mode ON.  The unit does not reset when you set this command.</p>	
"UL" 55H 4CH	<p><b>Programmable Light Sensor Dim Level (read/write)</b>  <b>"EULXLLLL"</b> where X is a flag (either "1" or "0") and LLLL is the dim level.  "0" [30H] — disable light sensor dim level. This sets the light sensor dim level to the default setting (50 or 150),  "1" [31H] — enable light sensor dim level.  depending on the version of firmware.</p> <p>LLLL — Light sensor dim level (HEX 0000-FFFF).</p> <p>Read the dim level using the "FUL" command. "FUL" returns data in the same format as above.</p>	
<b>For AlphaEclipse 3600, RoadStar, and StreetSmart signs with an Ethernet Adapter</b>		
"Ui" 55H 69H	"EUiXXX.XXX.XXX.XXX"	Set unit IP address, where X is a decimal number 0-9.
	"EUi255.255.255.255;XX-XX-XX-XX-XX"	Set unit MAC address, where X is a decimal number 0-9.
"Us" 55H 73H	"EUsXXX.XXX.XXX.XXX"	Set unit subnet, where X is a decimal number 0-9.
"Ug" 55H 67H	"EUgXXX.XXX.XXX.XXX"	Set unit gateway, where X is a decimal number 0-9.



### 7.14.2 Read Over-Temp Flag Command

**Table 111: Read Over-Temp Flag Command Syntax**

Command Header	Command Code Read Register	Temperature Register	Temperature Read Command
	"F" [46H]	"T" [54H]	"O" [4FH]

**Table 112: Response Syntax**

Command Header	Command Code Write Register	Temperature Register	Temperature Read Command	Flag	
	"E" [45H]	"T" [54H]	"O" [4FH]	"0" [30H] — overheat mode	"1" [31H] — normal operations

**Example:** request overhead flag.

Computer Sends: [SOH]Z00[STX]FTO[EOT]

Sign Responds: [SOH]Z00[STX]ETO1[EOT]

### 7.14.3 Read Compact Flash Status Command

**Table 113: Read Compact Flash Status Command Syntax**

Command Header	Command Code — Read Register	Compact Flash Status Register
	"F" [46H]	"F" [46H]

**Table 114: Response Syntax**

Response Header	Command Code — Write Register	Compact Flash Status Register	Flag	
	"E" [45H]	"F" [46H]	"0" [30H] — compact flash absent	"1" [31H] — compact flash present

**Example:** read compact flash status flag.

Computer sends: [SOH]Z00[STX]FF[EOT]

Sign responds: [SOH]000[STX]EF1[EOT] - Compact flash present.

### 7.14.4 Read Message Tracking Command

**Table 115: Read Message Tracking Command Syntax**

Command Header	Command Code — Read Register	Message Time Tracking Register	Text File Label
	"F" [46H]	"K" [4BH]	A valid text file label.

**Table 116: Response Syntax**

Response Header	Command Code — Write Register	Message Time Tracking Register	Text File Label	24 Track (HEX)
	"E" [45H]	"K" [4BH]	The text file label sent in command (above)	AAAAAAAA, (HOUR 0) BBBBBBBB, (HOUR 1) ..... WWWWWWW, (HOUR 23)

24 Track — 24 hour slots that track how many seconds the message is run each hour of the day. Up to 429496729 seconds (19999999H) in each slot.

Example: read time tracking.

Computer sends: [SOH]Z01[STX]FKA[EOT]

Sign responds: [SOH]000[STX]EKA00000010, 00000000, 00000000, 00000000, 00000000, 00000000, 00000000, 00000000, 00000000, 00000000, 00000000, 00000000, 00000000, 00000000, 00000000, 00000000, 00000000, 00000000, 00000000, 00000000[EOT]

Text file A has run for 16 seconds in the 12AM time slot.

### 7.14.5 Clear Message Time Tracking Command

**Table 117: Clear Message Time Tracking Command Syntax**

Command Header	Command Code — Write Register	Message Time Tracking Register	Text File Label
	"E" [45H]	K [4BH]	A valid text file label

Clear message tracking command clears the message track of the text file.

NOTES:

- A memory configuration (E\$....) will clear the message time of text files.
- A DIP switch memory clear will clear the message time of text files.
- The text message times are saved to compact flash every hour.

### 7.14.6 Turn ON/OFF Periodic Sampling Command

This command is used for turning off the internal network for production calibrations of the driver boards (brightness correction of the driver boards).

The command will turn ON/OFF the master device's sampling of the light sensor and temperature probe. This command is not permanent; when you reset the sign, the master sign returns to its default (sampling ON).

**Table 118: Turn ON/OFF Periodic Sampling Command Syntax**

Command Header	Write Register Command	Register	Flag	
	"E" [45H]	"P" [50H]	"0" [30H]— Turn off sampling	"1" [31H] — Turn on sampling

Example: turn off periodic sampling.

Computer sends: [SOH]Z00[STX]EP0[EOT]

**7.14.7 RGB Set Color in Text Attribute**

RGB Codes:

RGB	Command	Description
Change Font Color	[1CH]ZRRGGBB	RGB Values are 00H-FFH. RR — Red intensity (two bytes HEX) GG — Green intensity (two bytes HEX) BB — Blue intensity (two bytes HEX)
Change Shaded Font Color	[1CH]YRRGGBB	Change color of the shaded portion of the font. RR — Red intensity (two bytes HEX) GG — Green intensity (two bytes HEX) BB — Blue intensity (two bytes HEX)

For Example:

[SOH]Z00[STX]AA[1CH]Z00FF00[1CH]YC0C0C0[1DH]71**Green Characters With A Shade of Gray**[EOT]

**7.14.8 RGB GIF protocol (RGB Dot Additions)**

**7.14.8.1 RGB DOTS PICTURE File Configuration**

RGB DOTS PICTURE is configured the same as AlphaVision DOTS PICTURE "E8" with cc = "08". (See "E8" on page 26).

**7.14.8.2 Write/Read RGB DOTS PICTURE**

Command Code — "K" [4BH] for write.

Command Code — "L" [4CH] for read.

Same format as Write AlphaVision DOTS PICTURE (command code "M" and "N") except for row bit pattern. (See page 44 and page 46)

Each pixel is represented as "RRGGBB" where:

- RR = two ASCII HEX digits for red (range 00H - FFH).
- GG = two ASCII HEX digits for green (range 00H - FFH).
- BB = two ASCII HEX digits for blue (range 00H - FFH).

**7.14.8.3 Call AlphaVision DOTS PICTURE File [1F]**

Command “[1FH]SFFFFFFFFFtttt” where:

- S — “G” [47H] for faster flicks. Hold times are in 0.01 seconds.
- FFFFFFFFFF — file name.
- tttt — a 4-digit ASCII HEX number indicating the number of hundredths of seconds to hold.

Example:

[1FH]GGIF0000010001

**7.14.8.4 Call RGB DOTS PICTURE**

Same as “Call AlphaVision DOTS PICTURE File [1F]” (above) except:

- S — “A” [41H] if the file is running as part of a Quick Flick animation.

OR

- S — “P” [50H] if the file running is a DOTS PICTURE file.

These are analogous to “C” and “L” for AlphaVision DOTS PICTURES.

**7.14.9 Write/Read Serial Number**

**7.14.9.1 Write Serial Number**

This command sets the serial number of the unit. The serial number is stored on a 20 byte bin file (“SER\_NO.TXT”) on the compact flash card.

**Table 119: Write Serial Number Command Syntax**

Command Header	Command Code — Write Register	Command Register — Serial Number	Added Command String	20 ASCII Character Serial Number Field
	“E” [45H]	“A” [41H]	“MS Serial No:”	XXXXXXXXXXXXXXXXXXXX

Example: set serial number.

[SOH]Z00[STX]EAMS Serial No:3600 SDK124532 1344 [EOT]

**7.14.9.2 Read Serial Number**

This command reads the unit serial number.

**Table 120: Read Serial Number Command Syntax**

Header Command	Command Code — Read Register	Command Register — Serial Number
	“F” [46H]	“A” [41H]

Example: read unit serial number.

[SOH]Z00[STX]FA[EOT]

### 7.15 Appendix O: Font character sets

#### 7.15.1 5-High Regular (SS5)

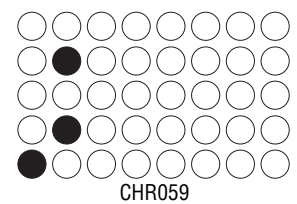
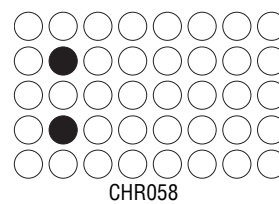
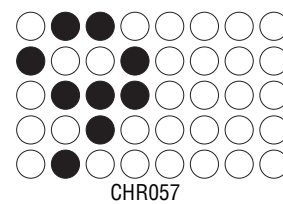
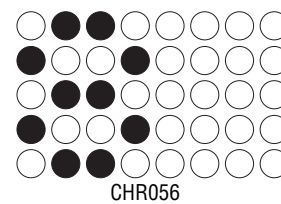
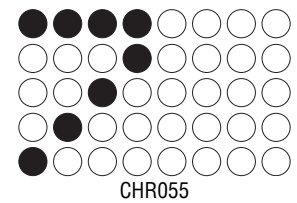
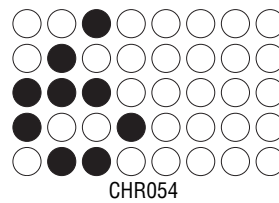
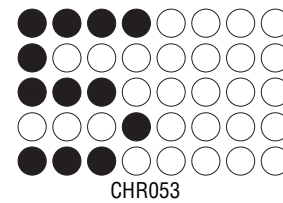
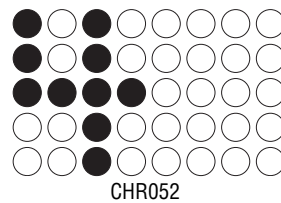
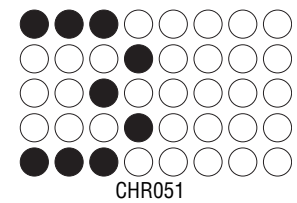
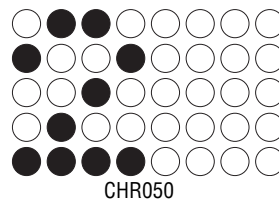
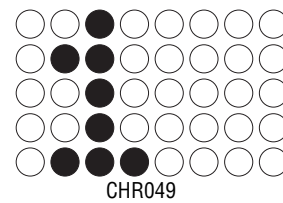
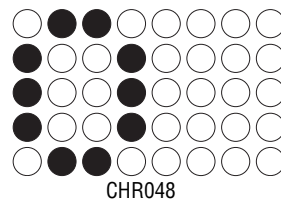
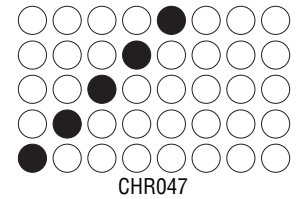
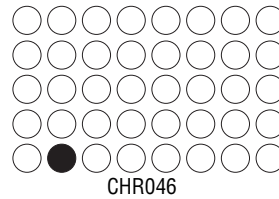
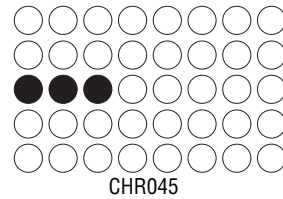
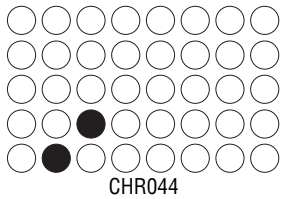
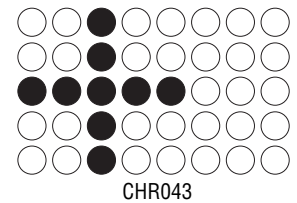
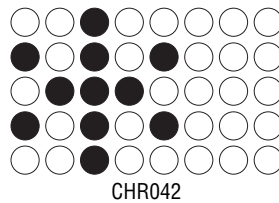
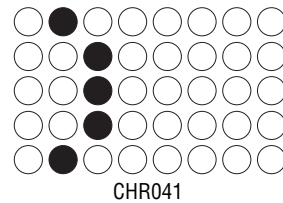
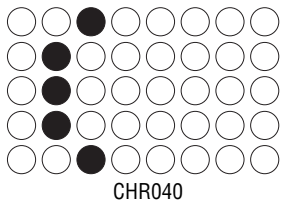
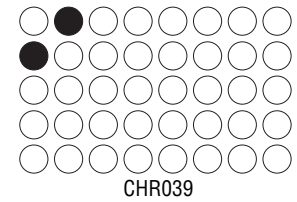
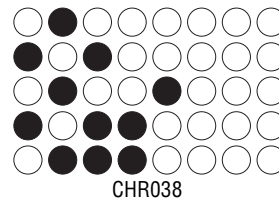
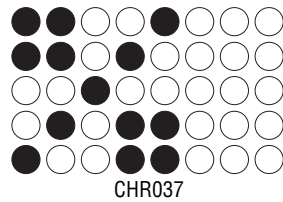
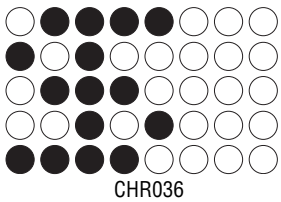
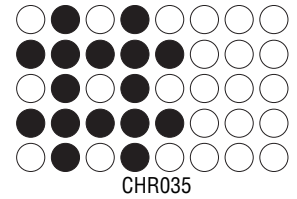
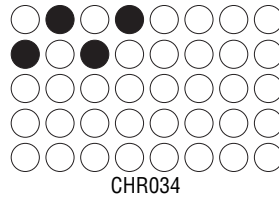
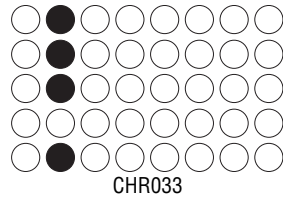
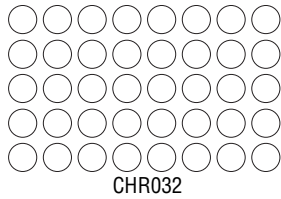



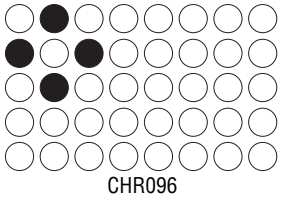
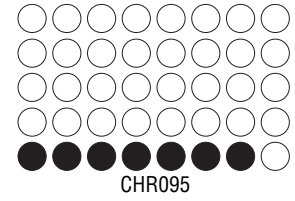
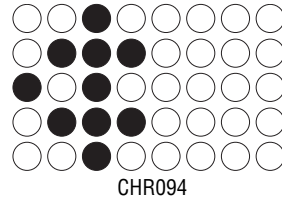
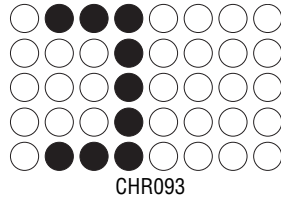
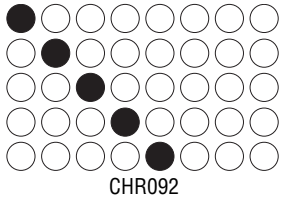

**7.15.2 7-High Regular (SS7)**

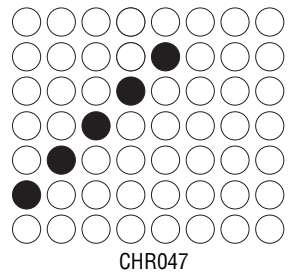
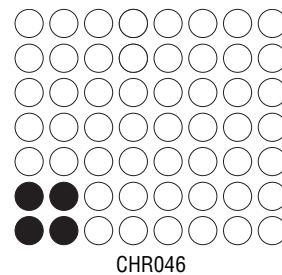
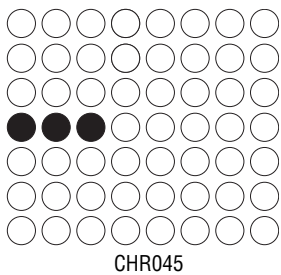
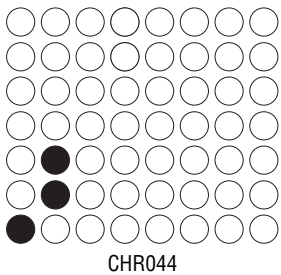
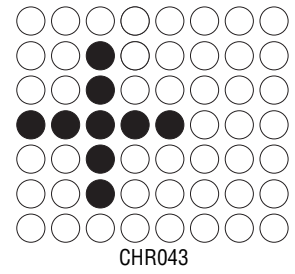
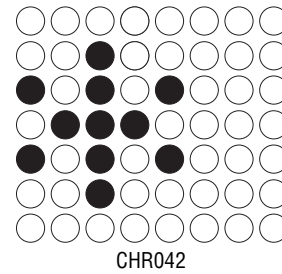
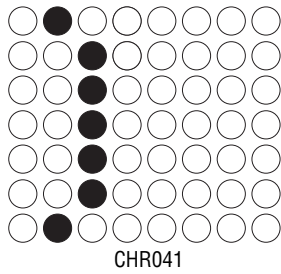
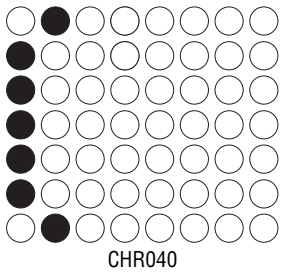
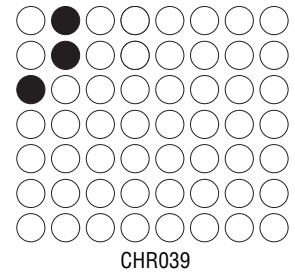
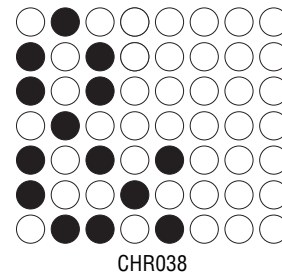
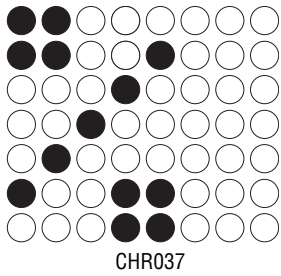
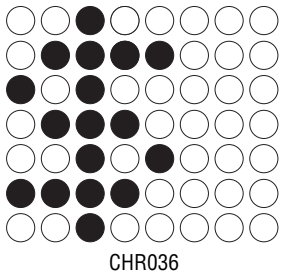
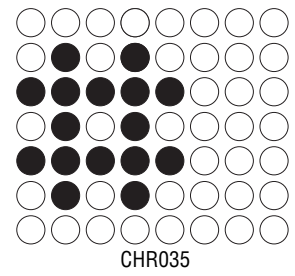
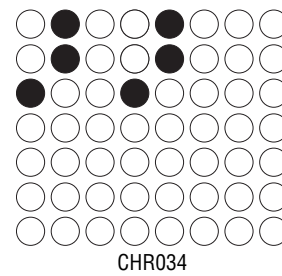
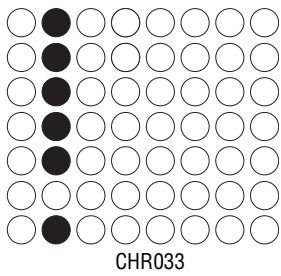
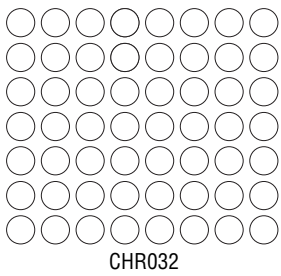





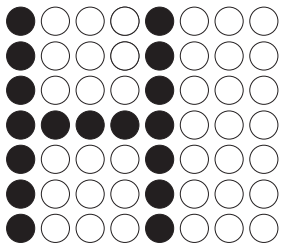

CHR072

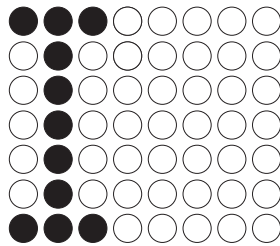

CHR073

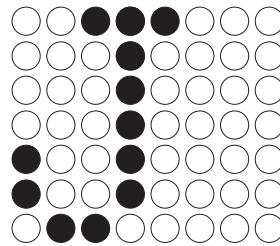

CHR074

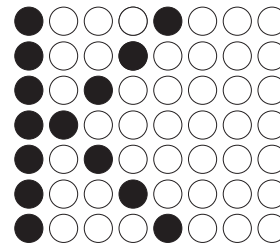

CHR075

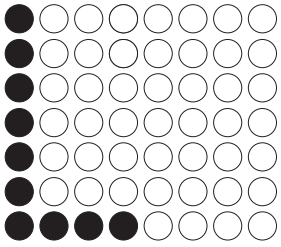

CHR076

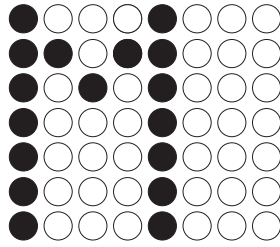

CHR077

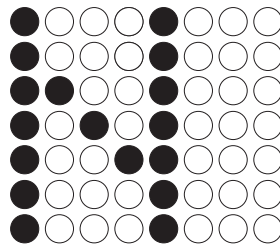

CHR078

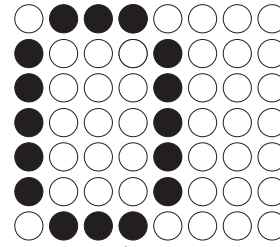

CHR079

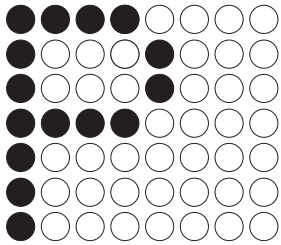

CHR080

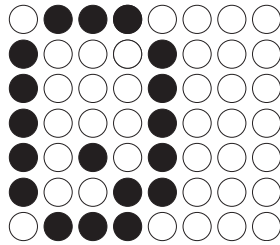

CHR081

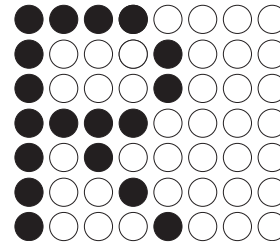

CHR082

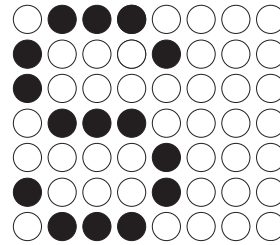

CHR083

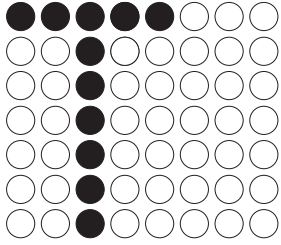

CHR084

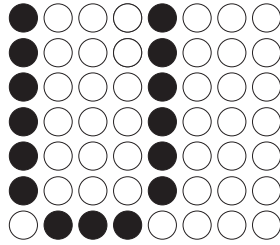

CHR085

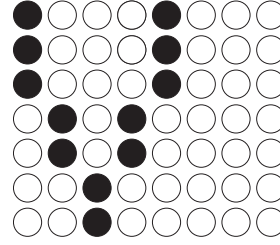

CHR086

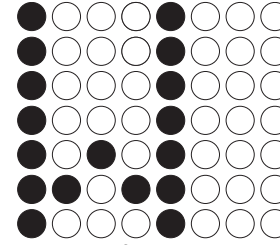

CHR087

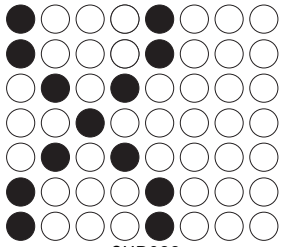

CHR088

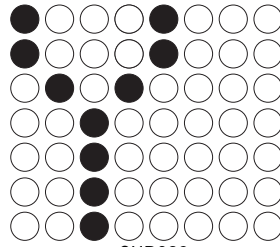

CHR089

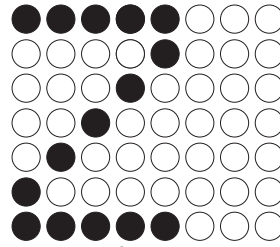

CHR090

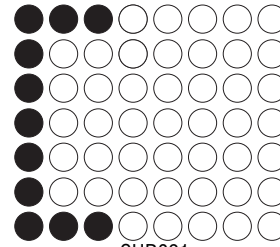

CHR091

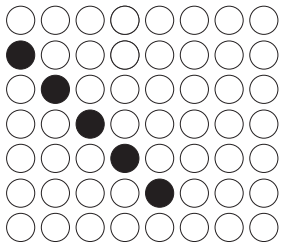

CHR092

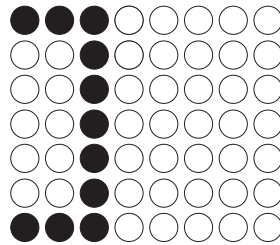

CHR093

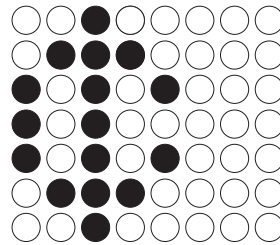

CHR094

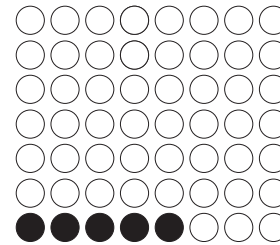

CHR095

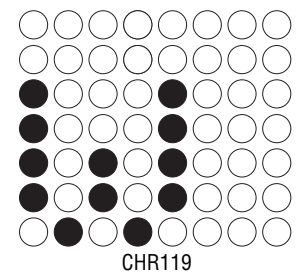
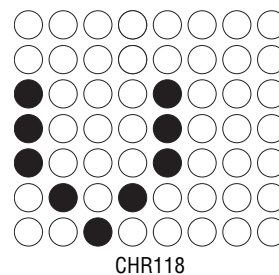
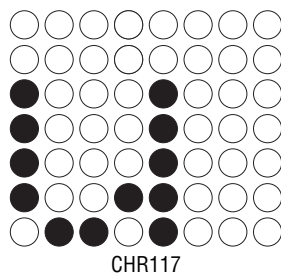
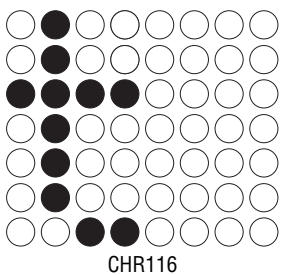
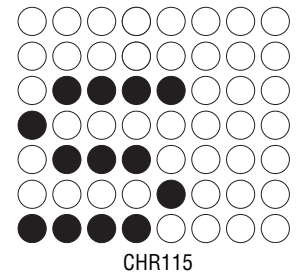
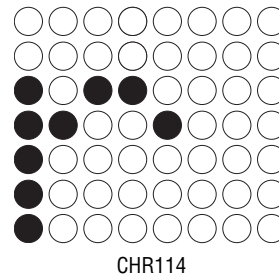
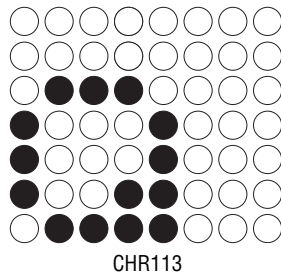
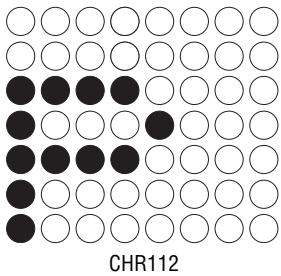
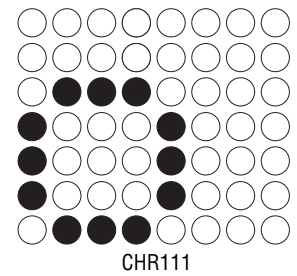
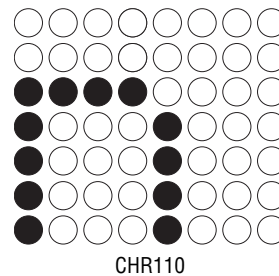
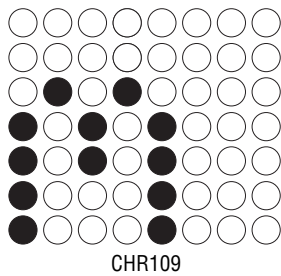
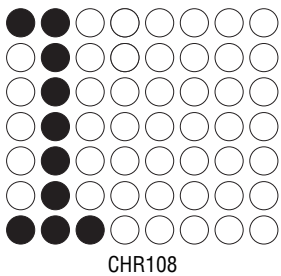
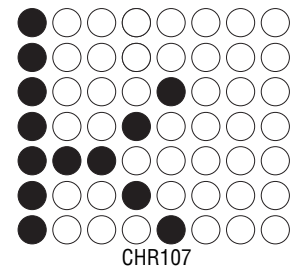
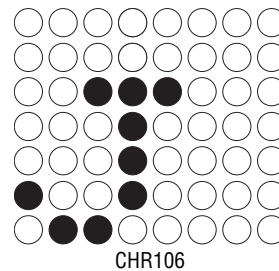
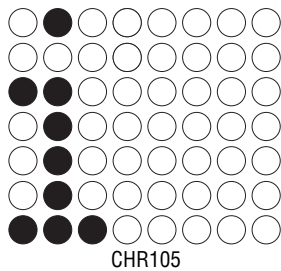
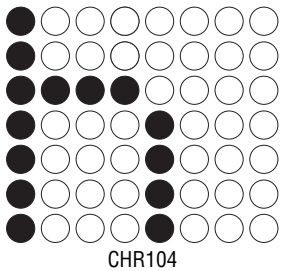
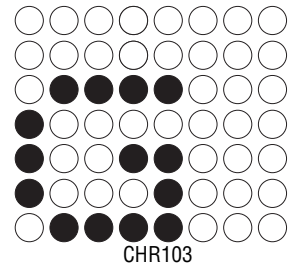
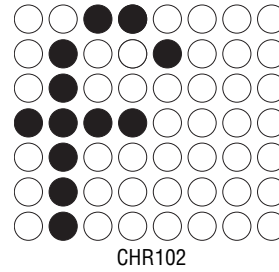
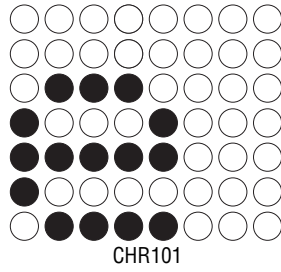
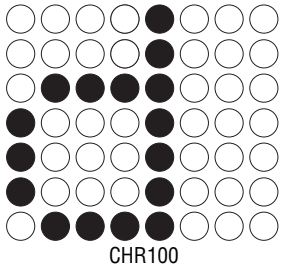
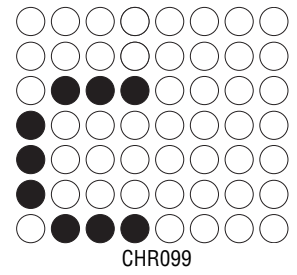
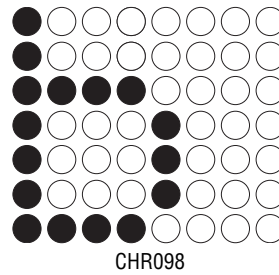
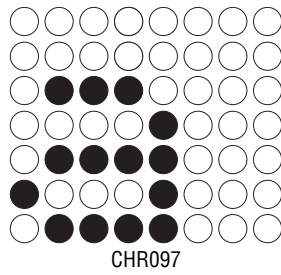
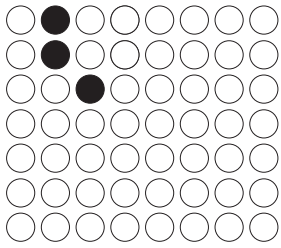

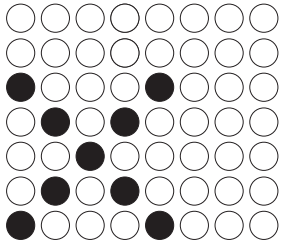

CHR120

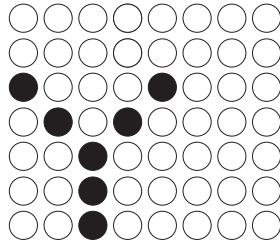

CHR121

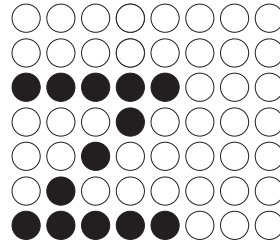

CHR122

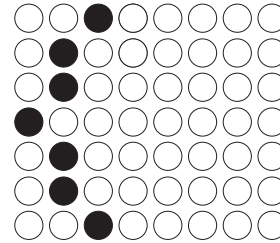

CHR123

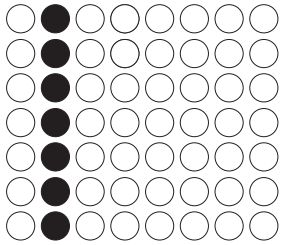

CHR124

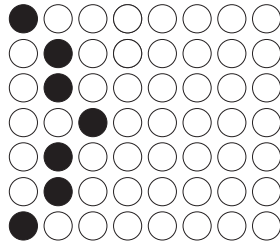

CHR125

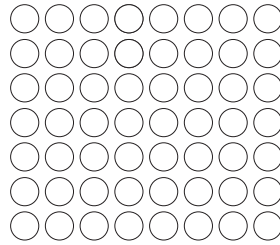

CHR126

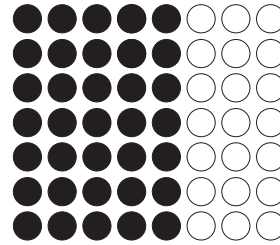

CHR127

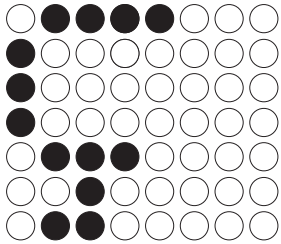

CHR128

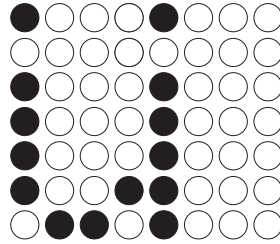

CHR129

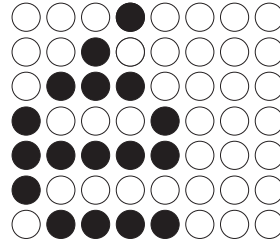

CHR130

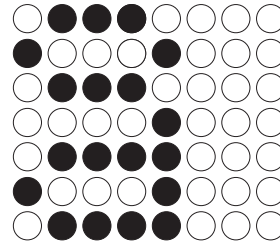

CHR131

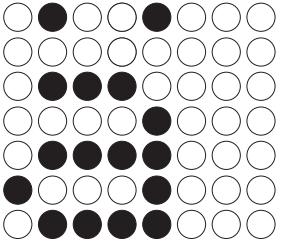

CHR132

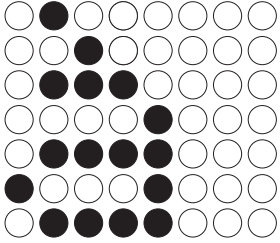

CHR133

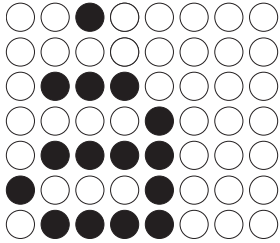

CHR134

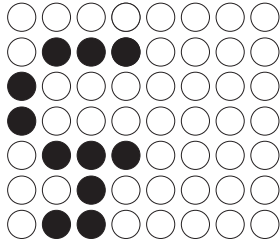

CHR135

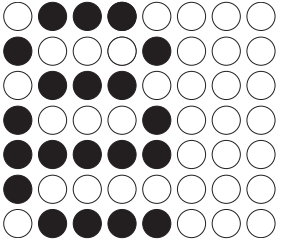

CHR136

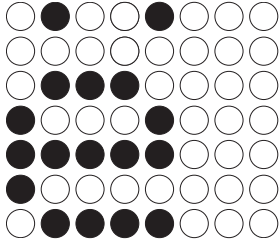

CHR137

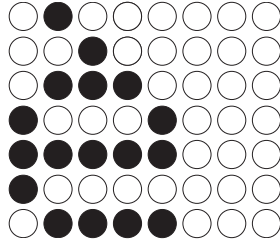

CHR138

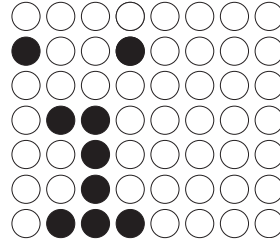

CHR139

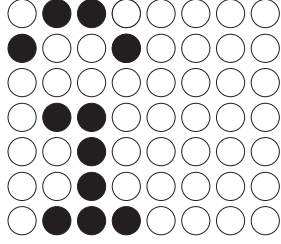

CHR140

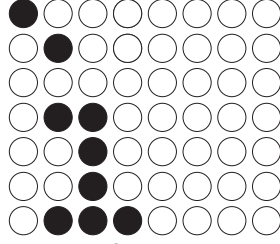

CHR141

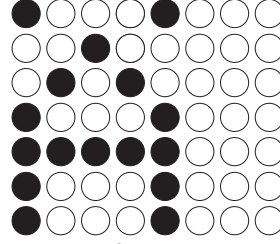

CHR142

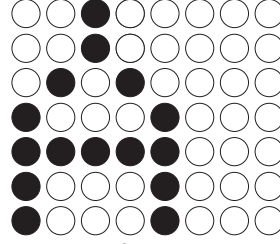

CHR143



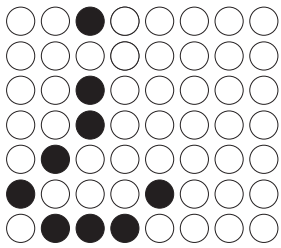

CHR168

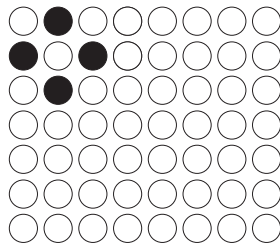

CHR169

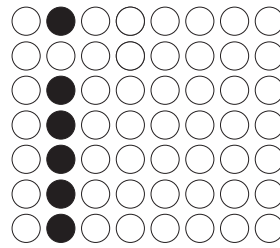

CHR170

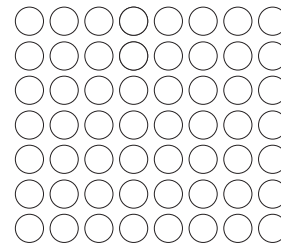

CHR171

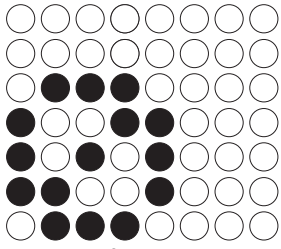

CHR172

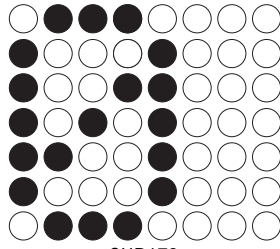

CHR173

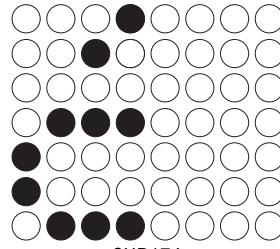

CHR174

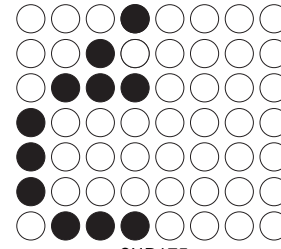

CHR175

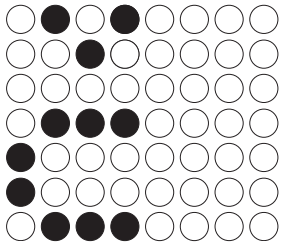

CHR176

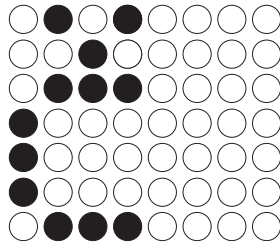

CHR177

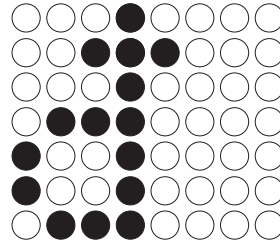

CHR178

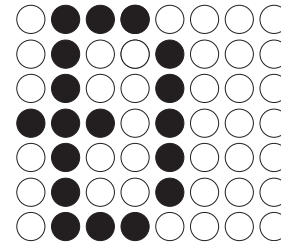

CHR179

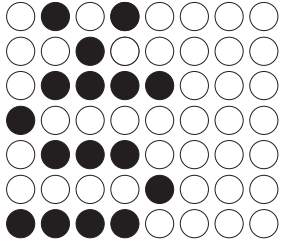

CHR180

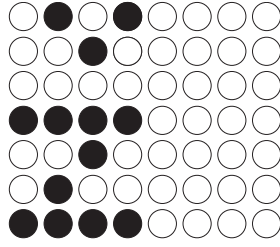

CHR181

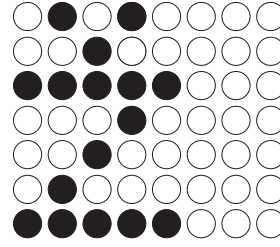

CHR182

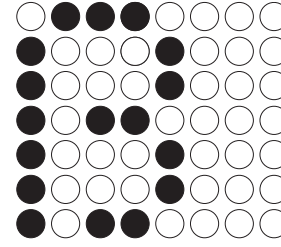

CHR183

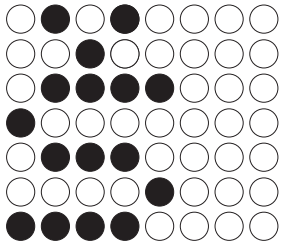

CHR184

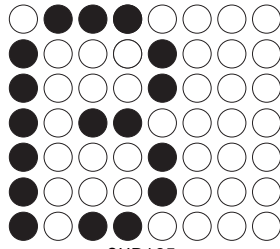

CHR185

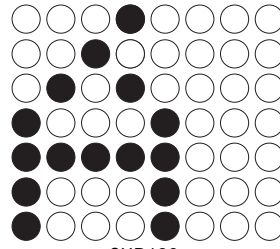

CHR186

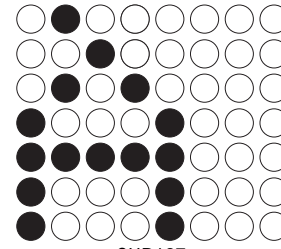

CHR187

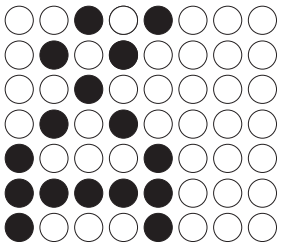

CHR188

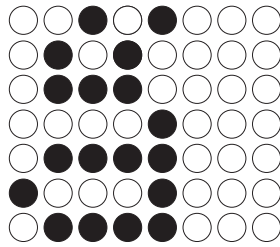

CHR189

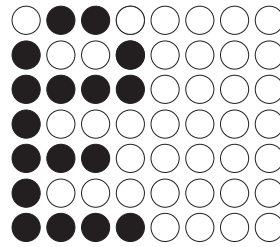

CHR190

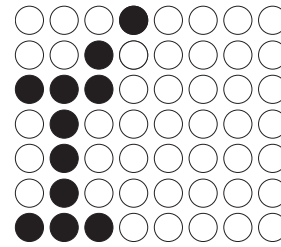

CHR191

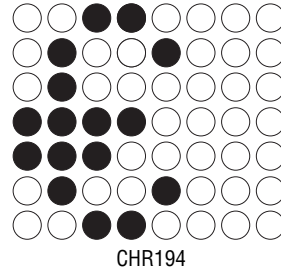
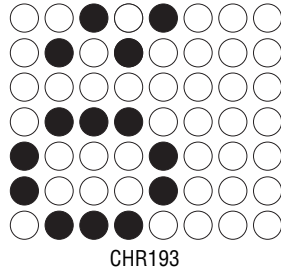
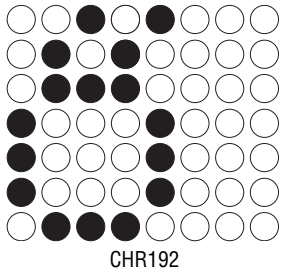

**7.15.3 7-High Fancy (SF7)**

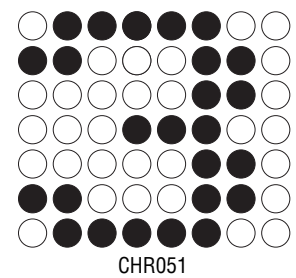
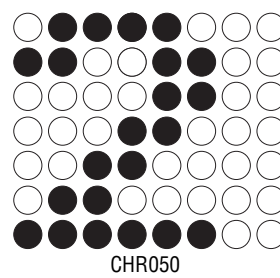
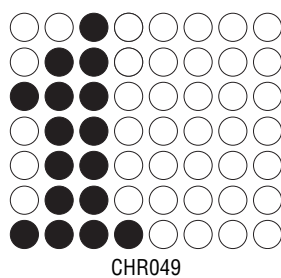
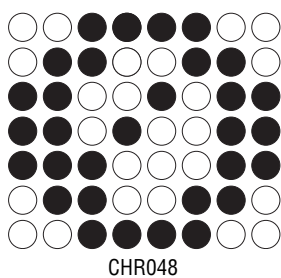
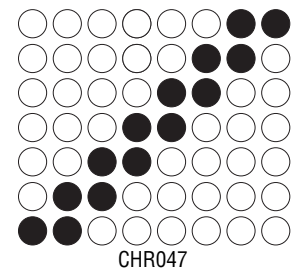
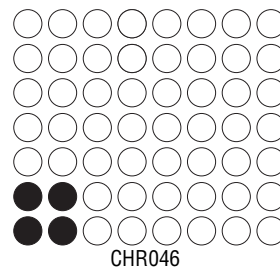
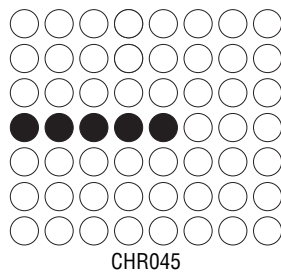
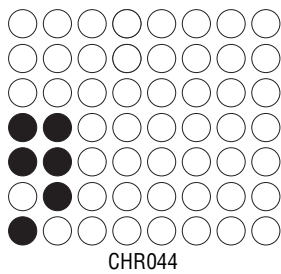
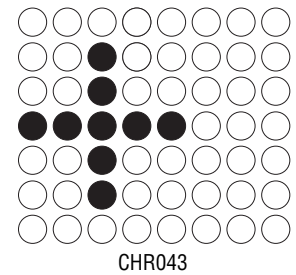
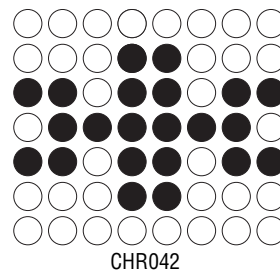
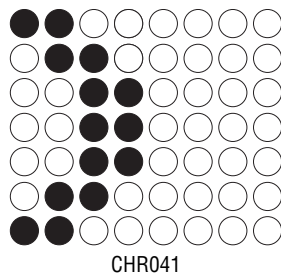
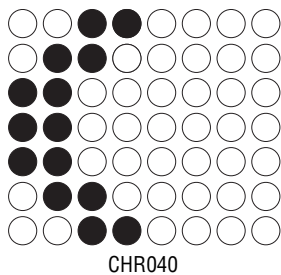
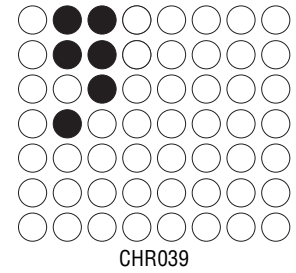
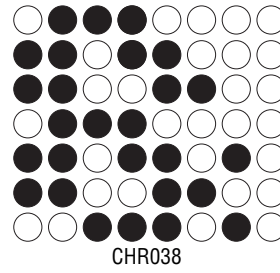
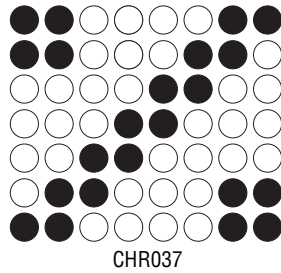
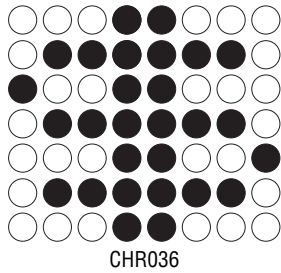
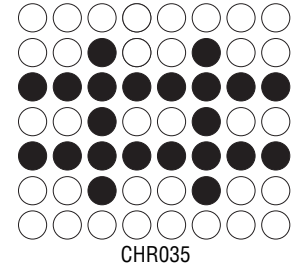
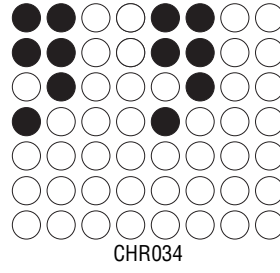
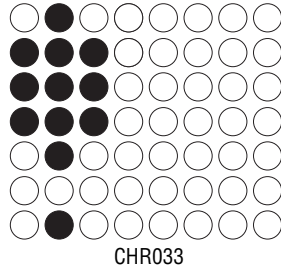
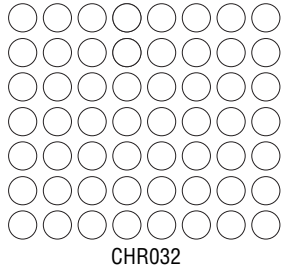



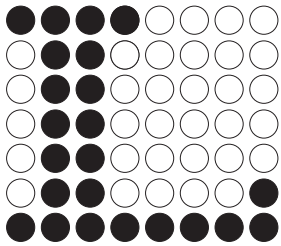

CHR076

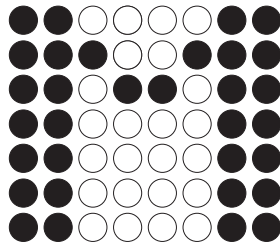

CHR077

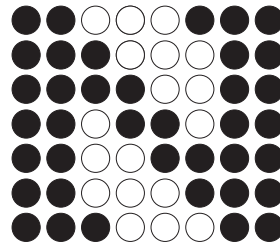

CHR078

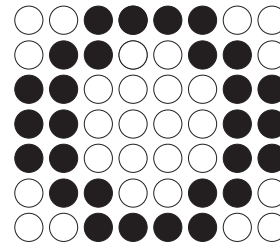

CHR079

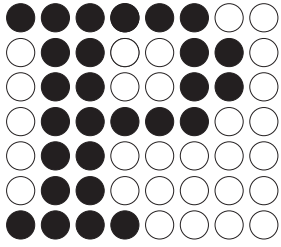

CHR080

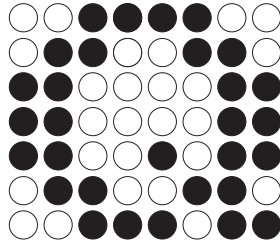

CHR081

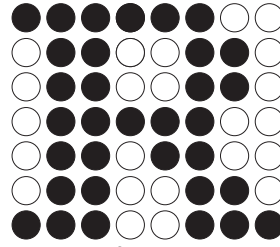

CHR082

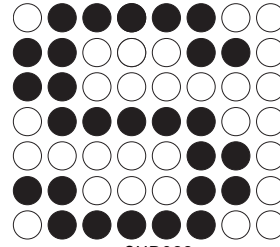

CHR083

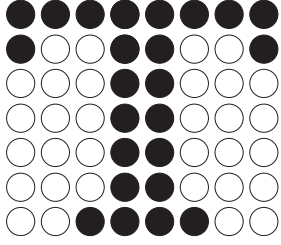

CHR084

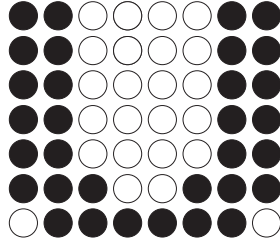

CHR085

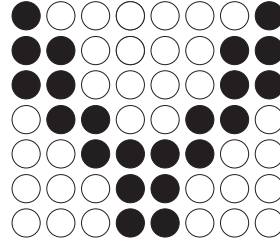

CHR086

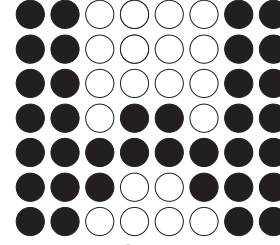

CHR087

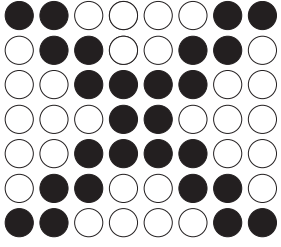

CHR088

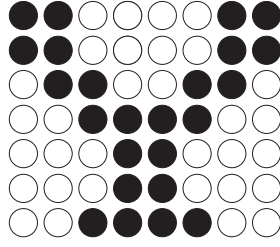

CHR089

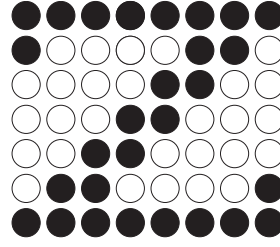

CHR090

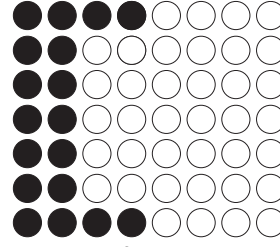

CHR091

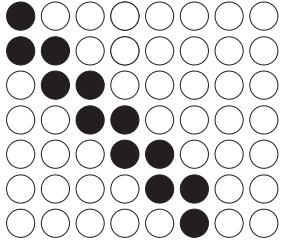

CHR092

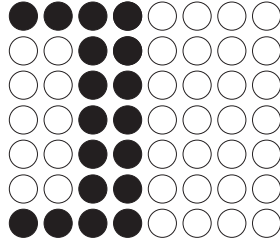

CHR093

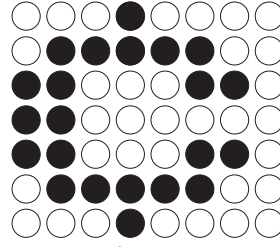

CHR094

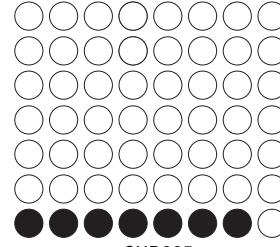

CHR095

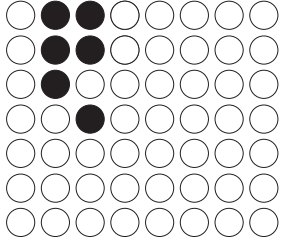

CHR096

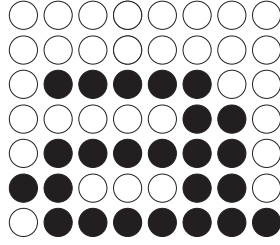

CHR097

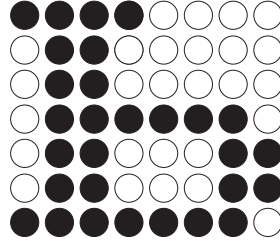

CHR098

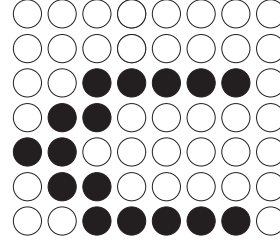

CHR099



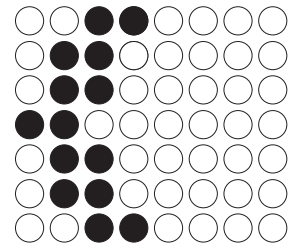
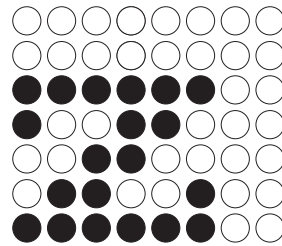
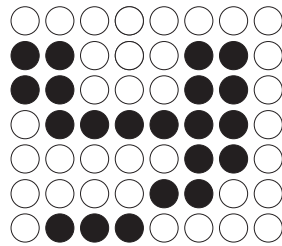
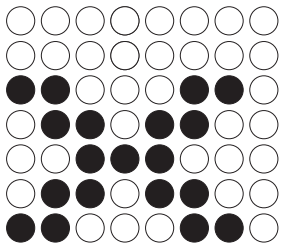
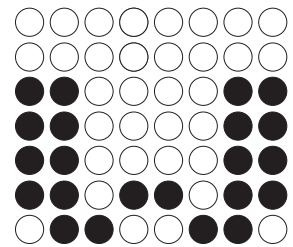
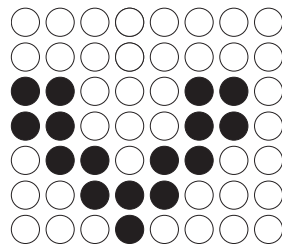
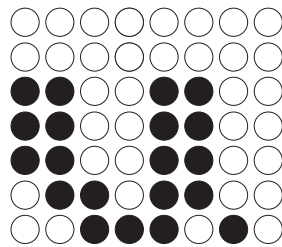
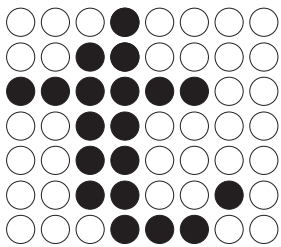
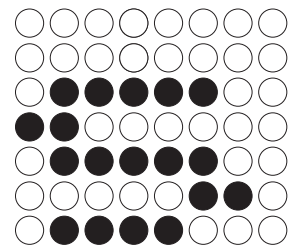
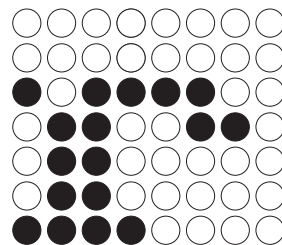
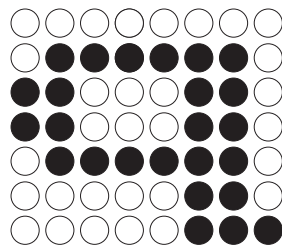
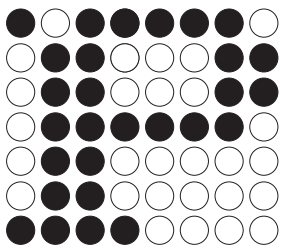
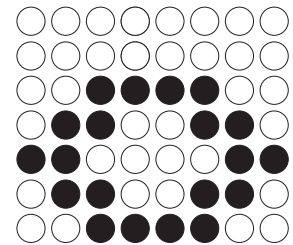
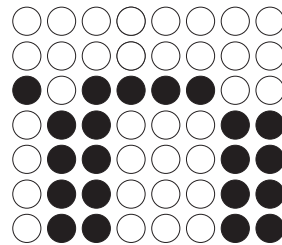
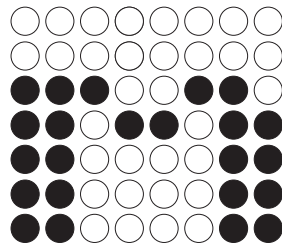
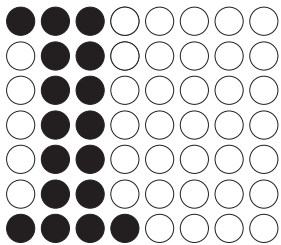
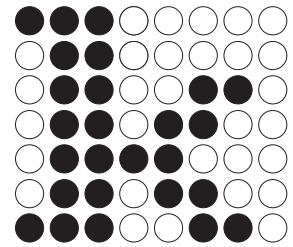
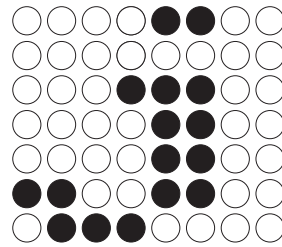
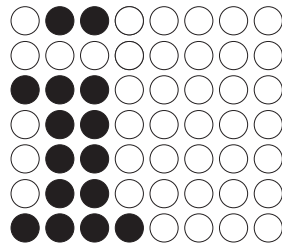
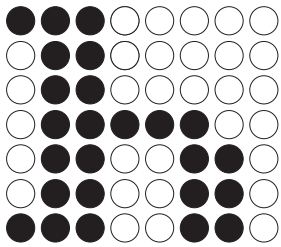
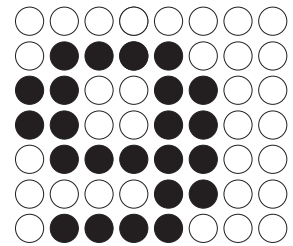
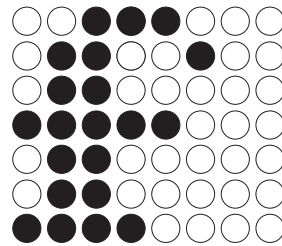
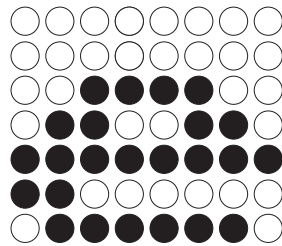
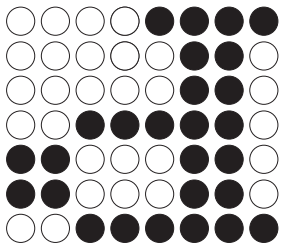

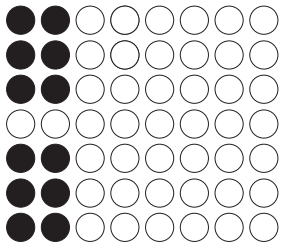

CHR124

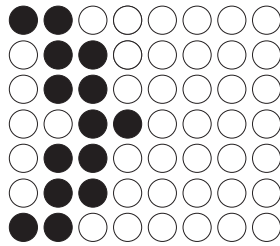

CHR125

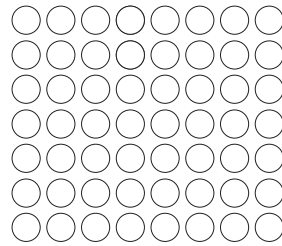

CHR126

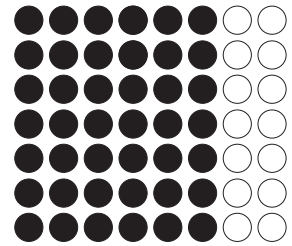

CHR127

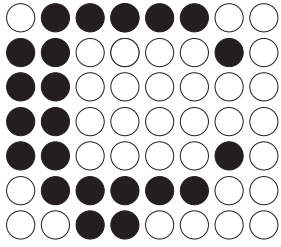

CHR128

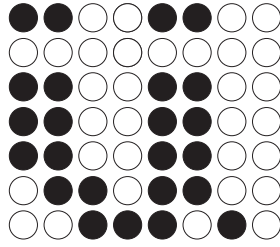

CHR129

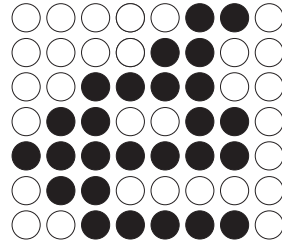

CHR130

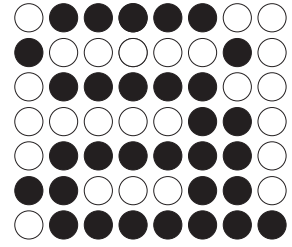

CHR131

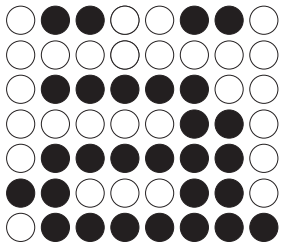

CHR132

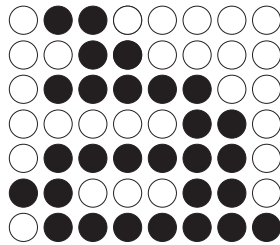

CHR133

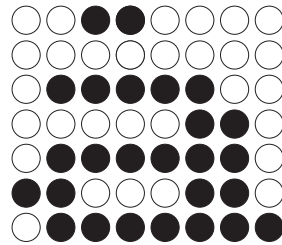

CHR134

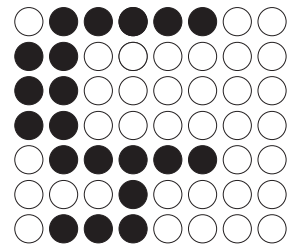

CHR135

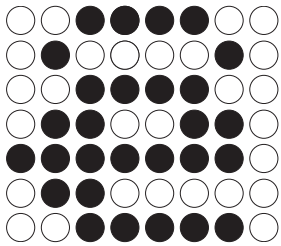

CHR136

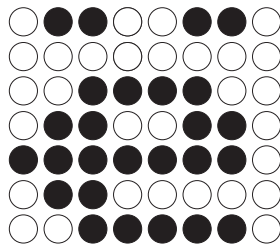

CHR137

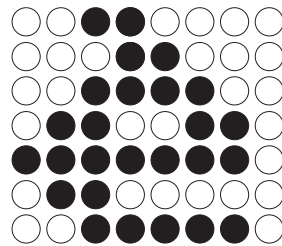

CHR138

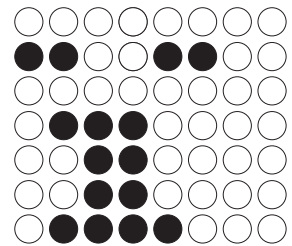

CHR139

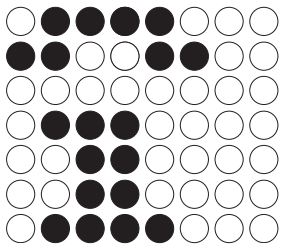

CHR140

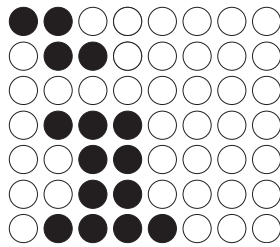

CHR141

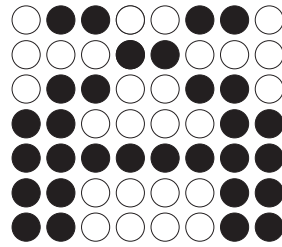

CHR142

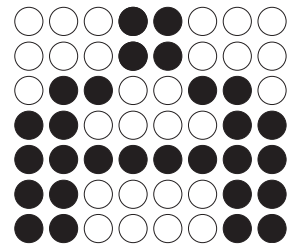

CHR143

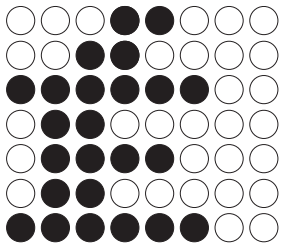

CHR144

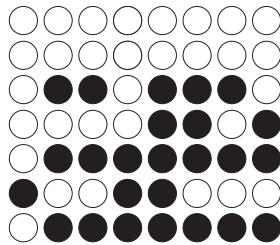

CHR145

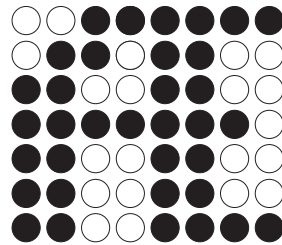

CHR146

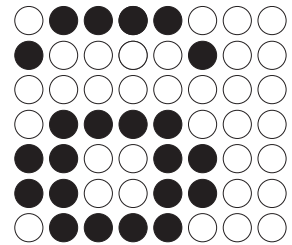

CHR147

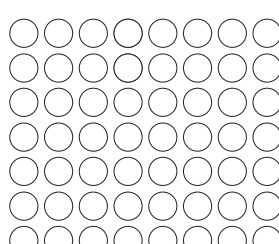
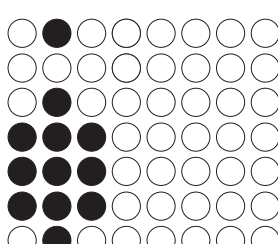
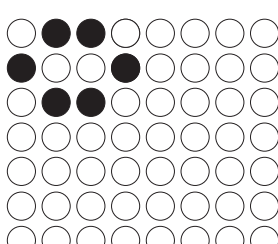
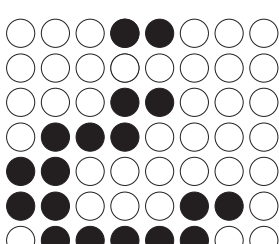
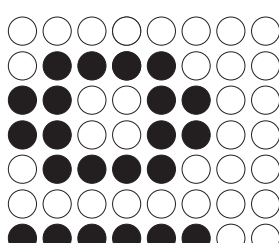
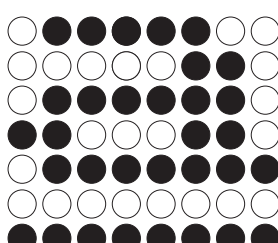
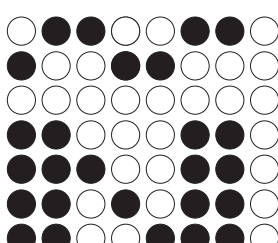
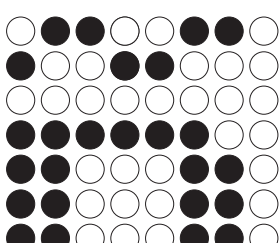
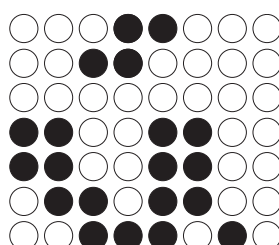
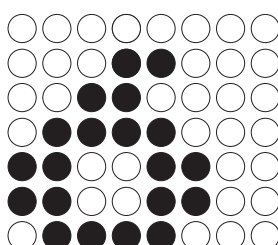
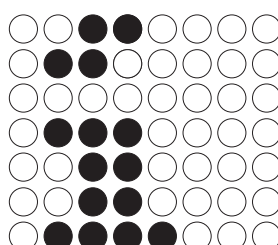
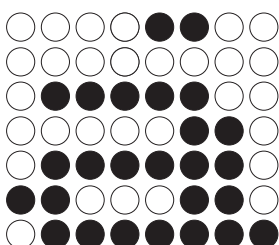
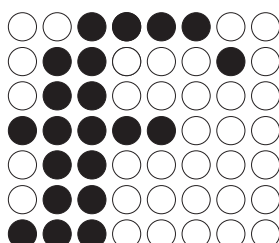
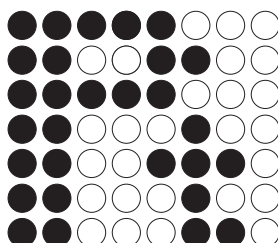
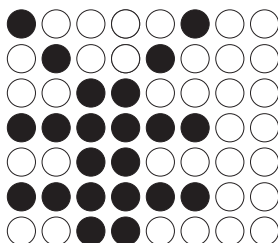
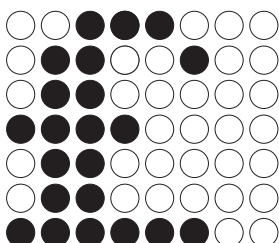
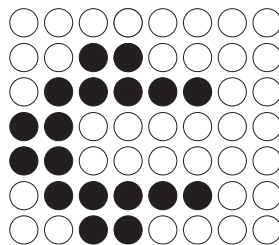
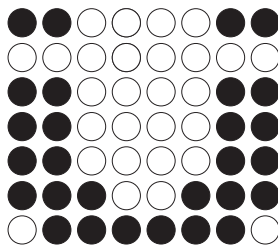
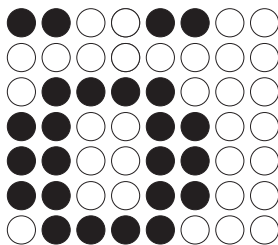
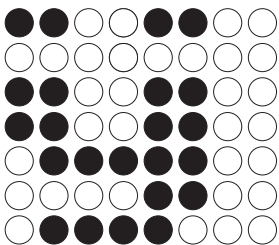
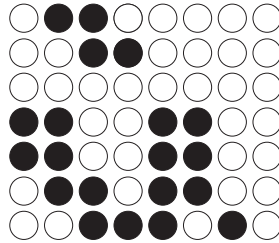
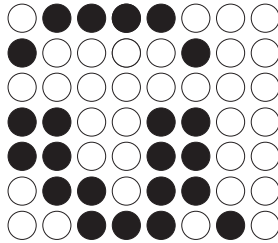
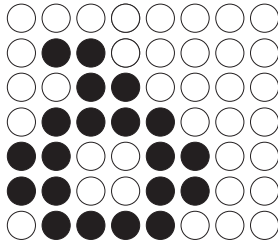
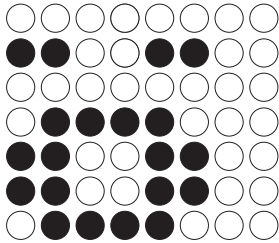

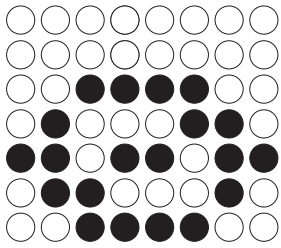

CHR172

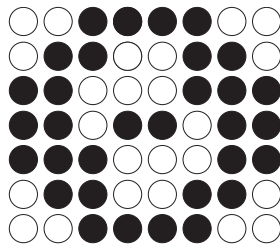

CHR173

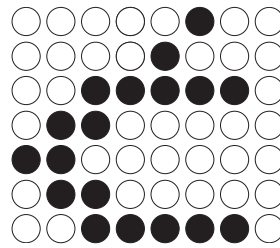

CHR174

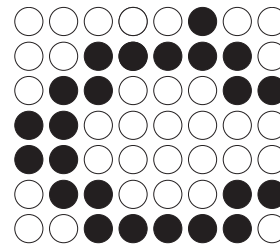

CHR175

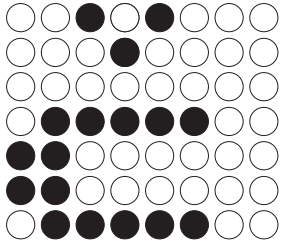

CHR176

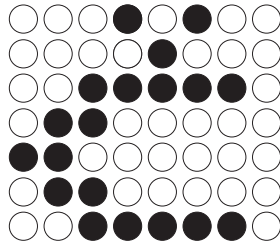

CHR177

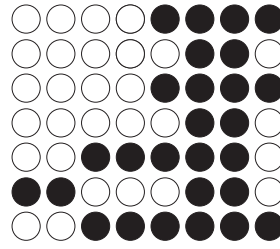

CHR178

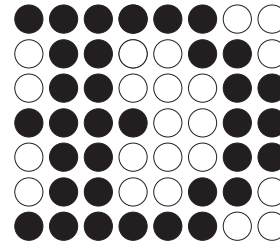

CHR179

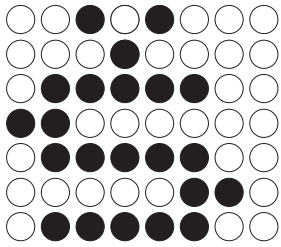

CHR180

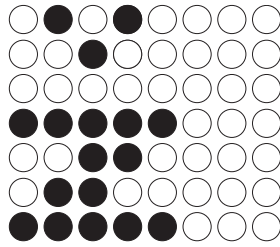

CHR181

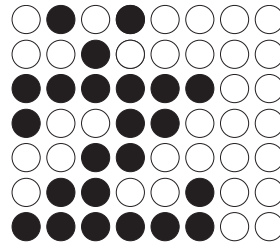

CHR182

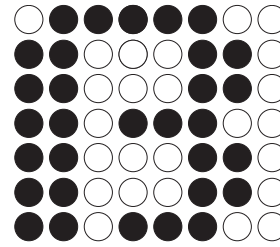

CHR183

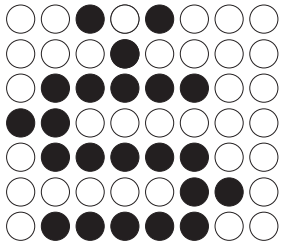

CHR184

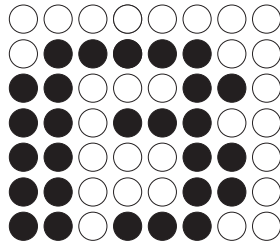

CHR185

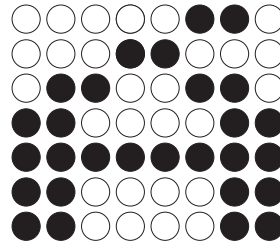

CHR186

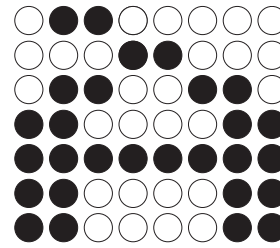

CHR187

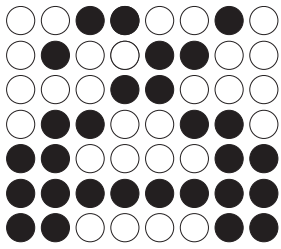

CHR188

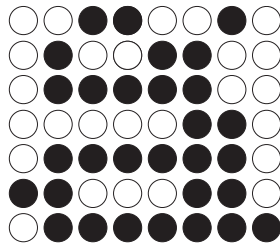

CHR189

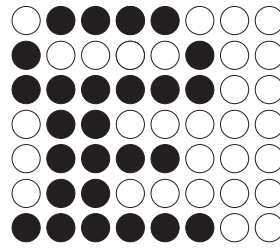

CHR190

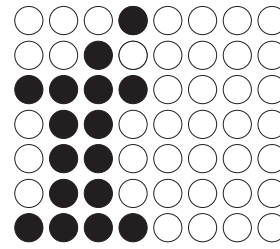

CHR191

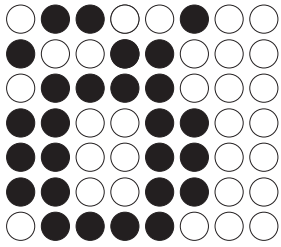

CHR192

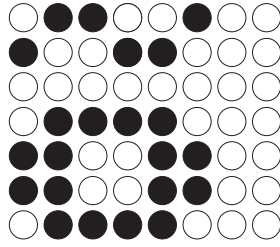

CHR193

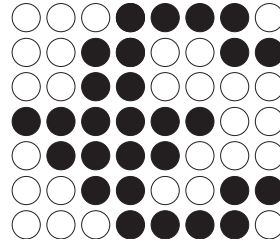

CHR194

### 7.15.4 7-High True Descender Regular

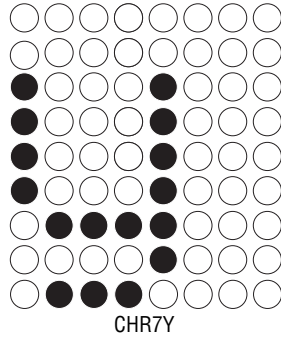
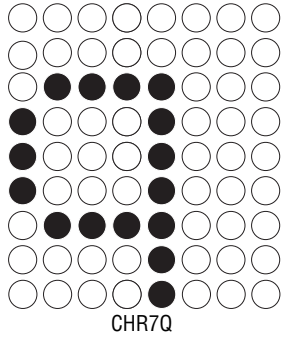
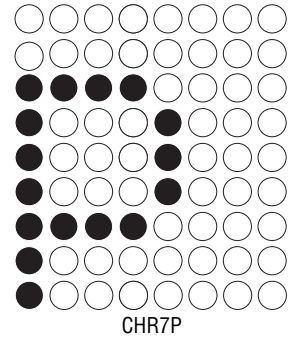
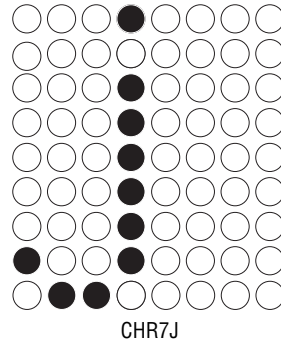
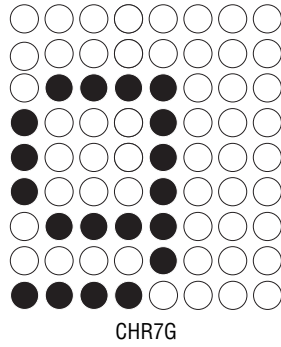
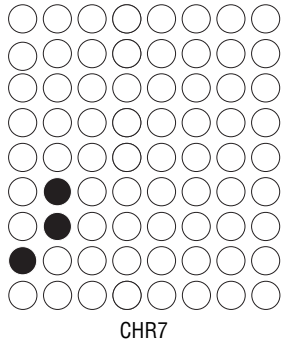

### 7.15.5 7-High True Descender Fancy

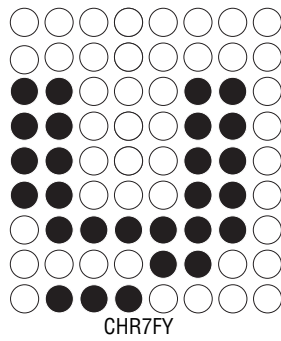
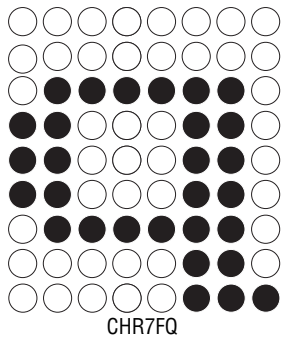
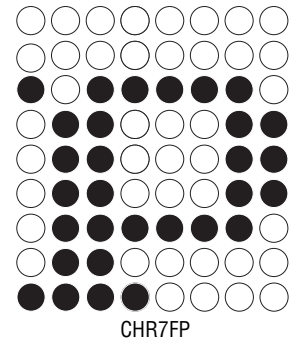
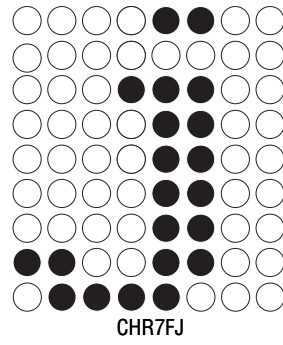
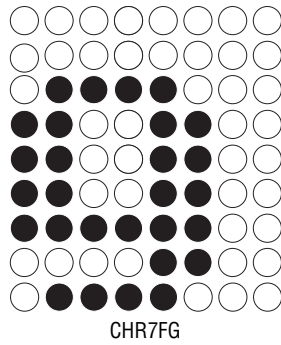
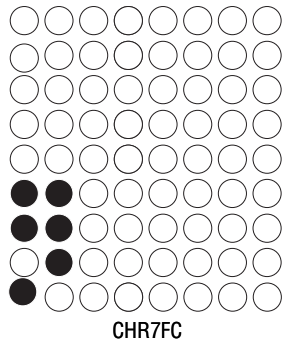

**7.15.6 7-High Fat Character**

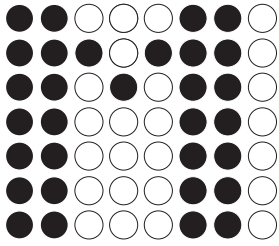

FTSM

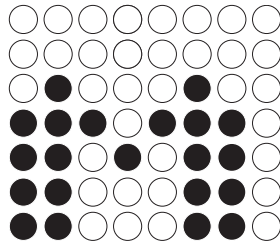

FTSM1

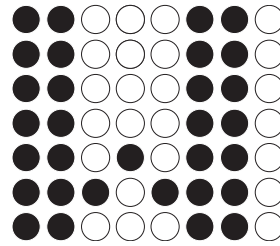

FTSW

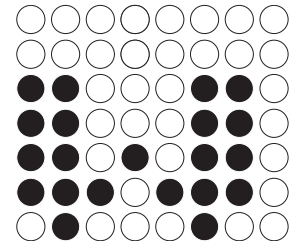

FTSW1

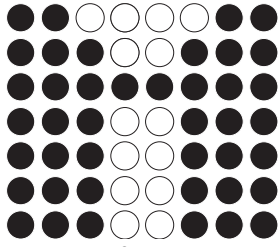

SFTM

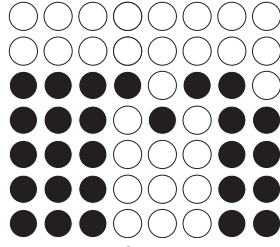

SFTM1

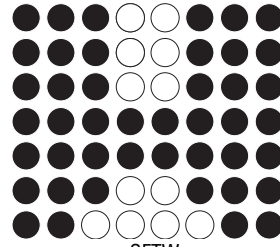

SFTW

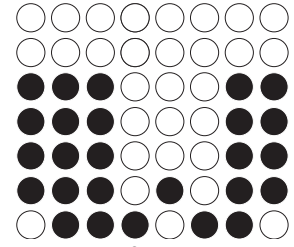

SFTW1

**7.15.7 8-High Regular (SS8)**

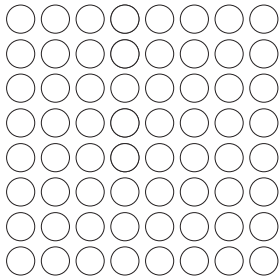

CHR032

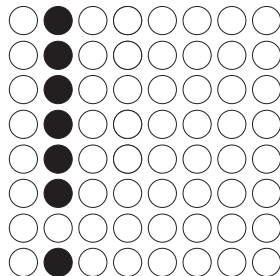

CHR033

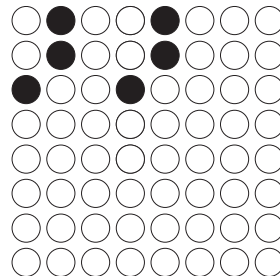

CHR034

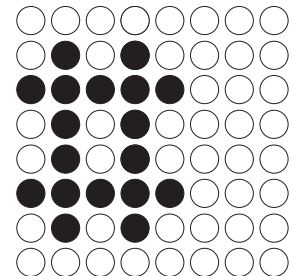

CHR035

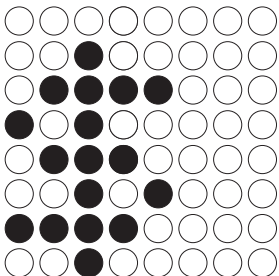

CHR036

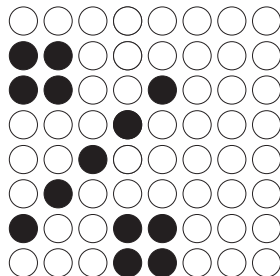

CHR037

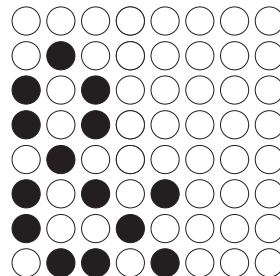

CHR038

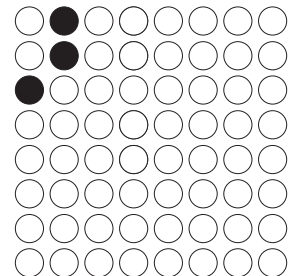

CHR039

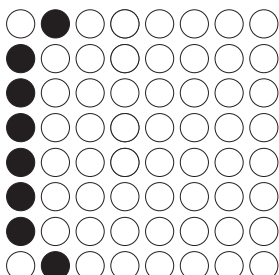

CHR040

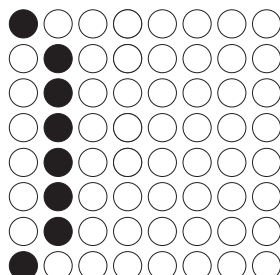

CHR041

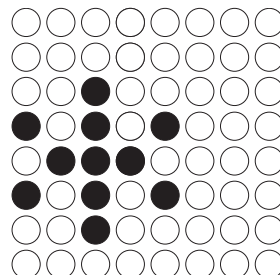

CHR042

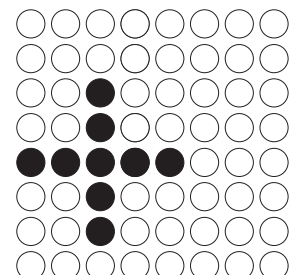

CHR043

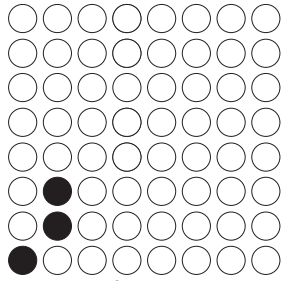

CHR044

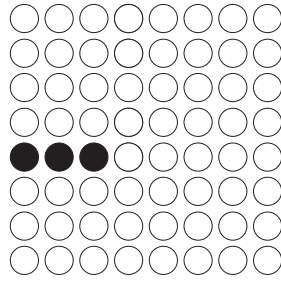

CHR045

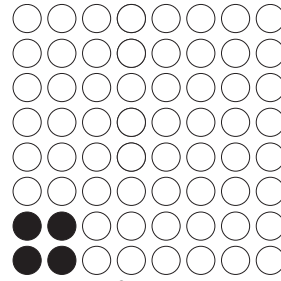

CHR046

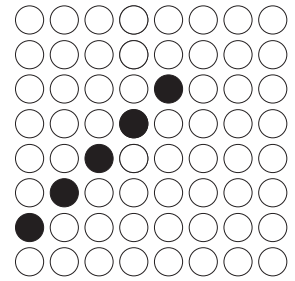

CHR047

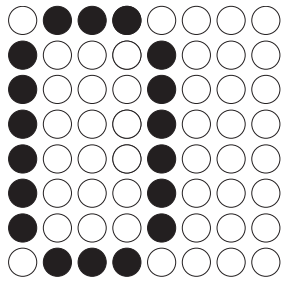

CHR048

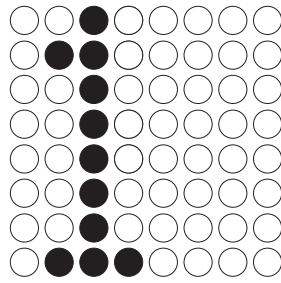

CHR049

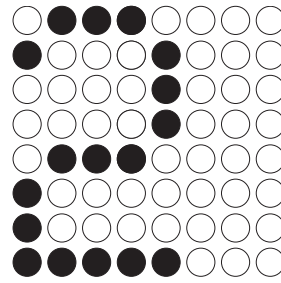

CHR050

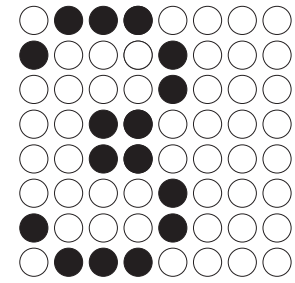

CHR051

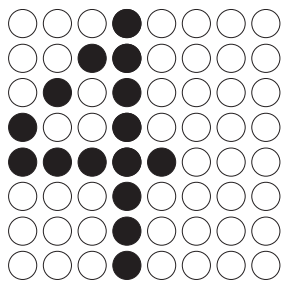

CHR052

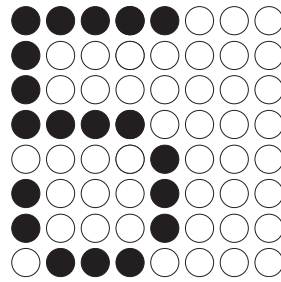

CHR053

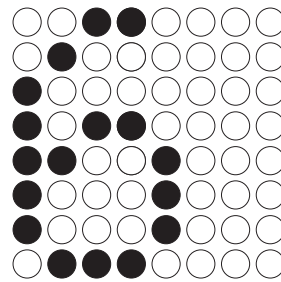

CHR054

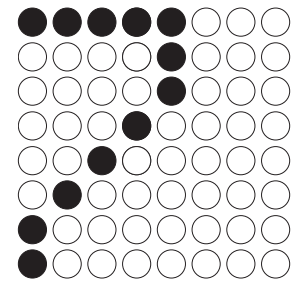

CHR055

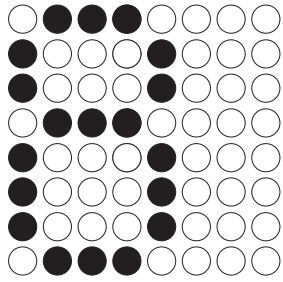

CHR056

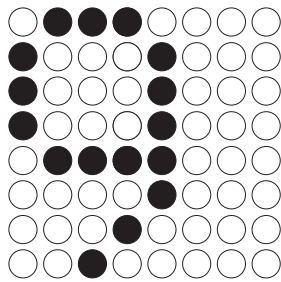

CHR057

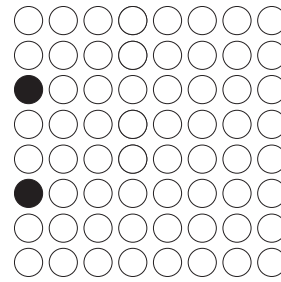

CHR058

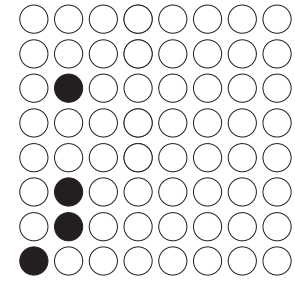

CHR059

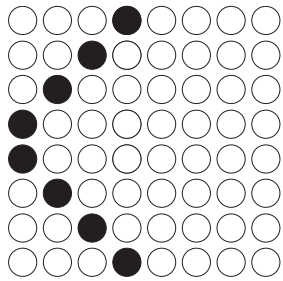

CHR060

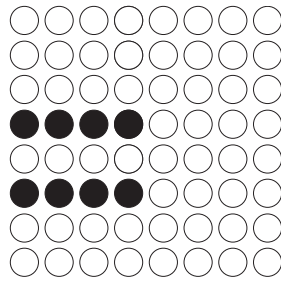

CHR061

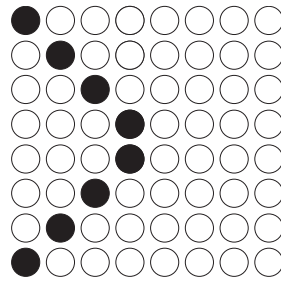

CHR062

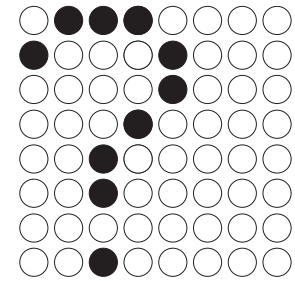

CHR063

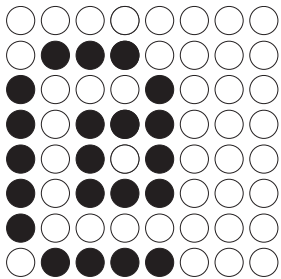

CHR064

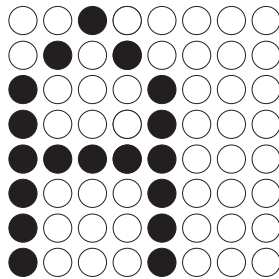

CHR065

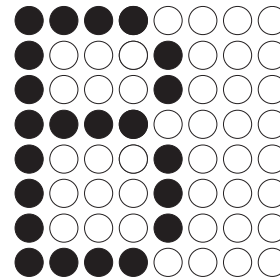

CHR066

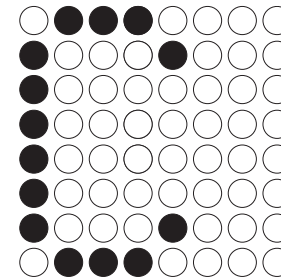

CHR067

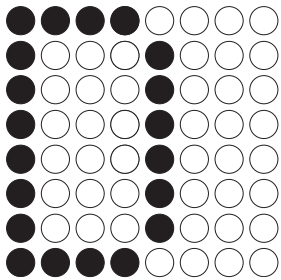

CHR068

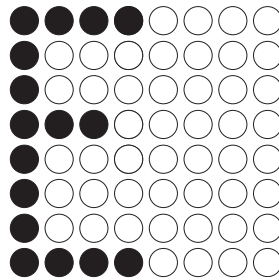

CHR069

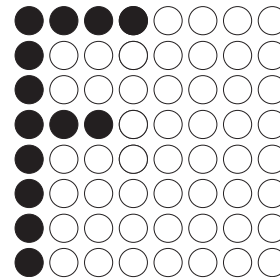

CHR070

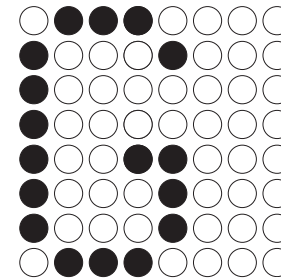

CHR071

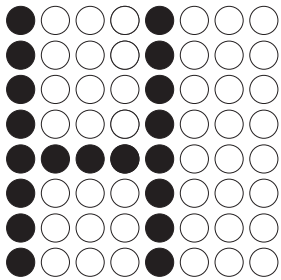

CHR072

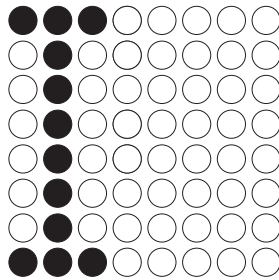

CHR073

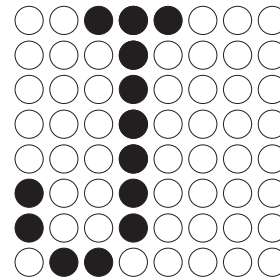

CHR074

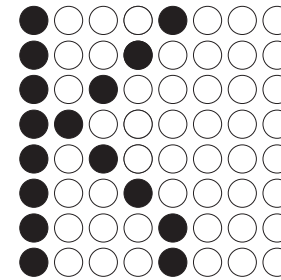

CHR075

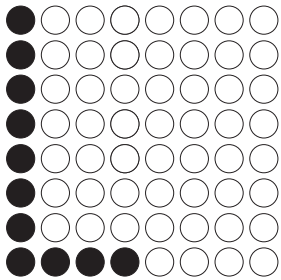

CHR076

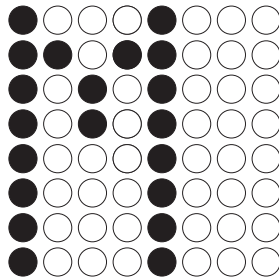

CHR077

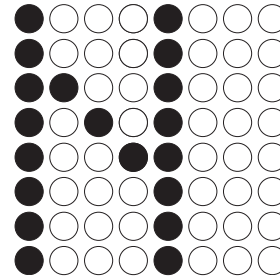

CHR078

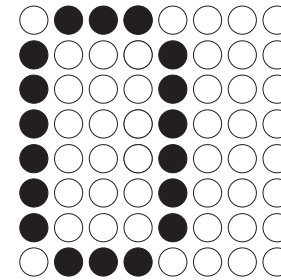

CHR079

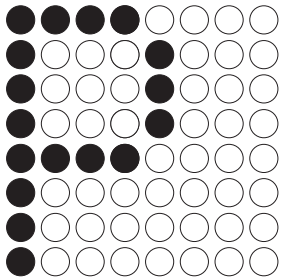

CHR080

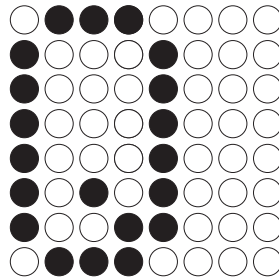

CHR081

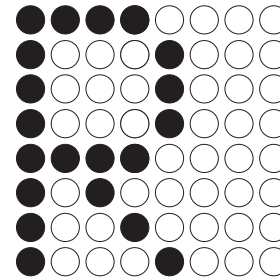

CHR082

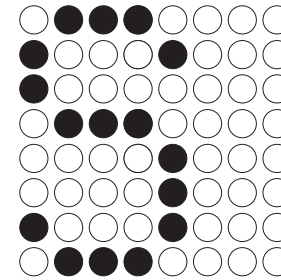

CHR083





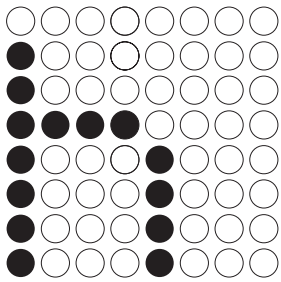

CHR104

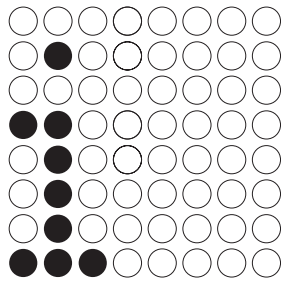

CHR105

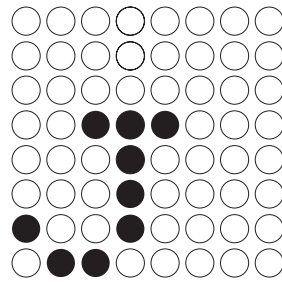

CHR106

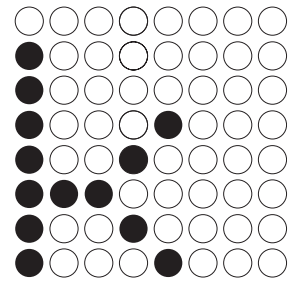

CHR107

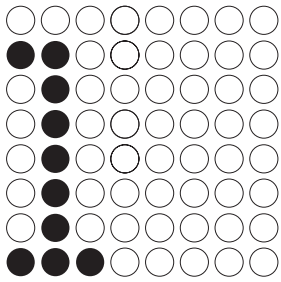

CHR108

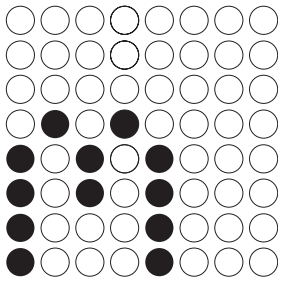

CHR109

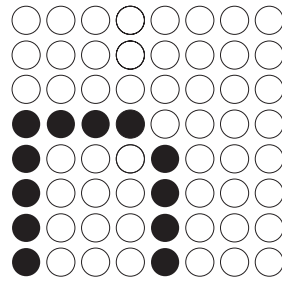

CHR110

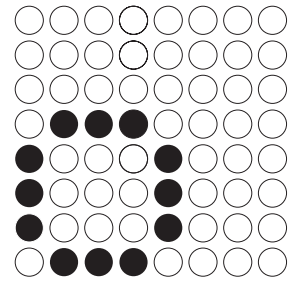

CHR111

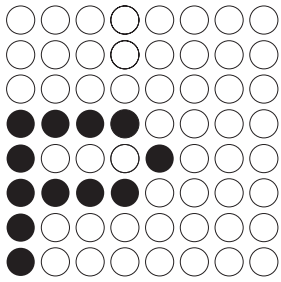

CHR112

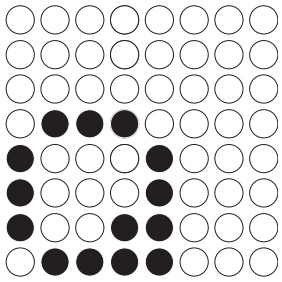

CHR113

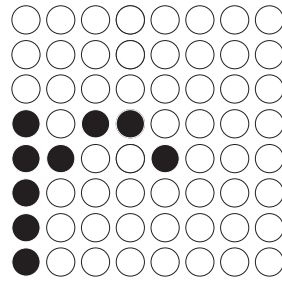

CHR114

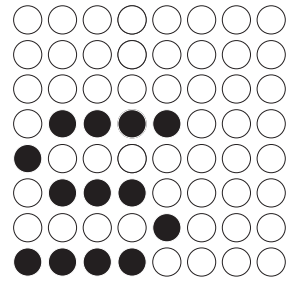

CHR115

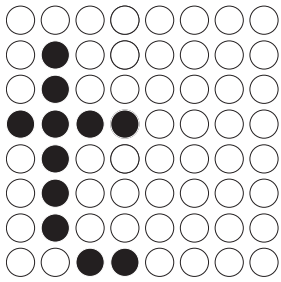

CHR116

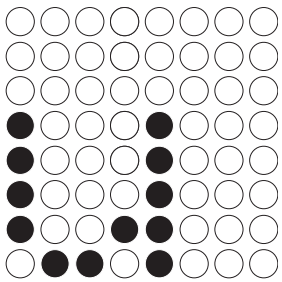

CHR117

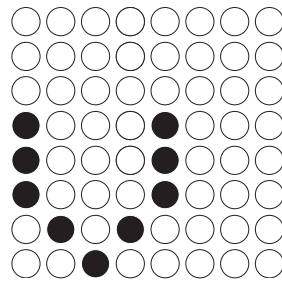

CHR118

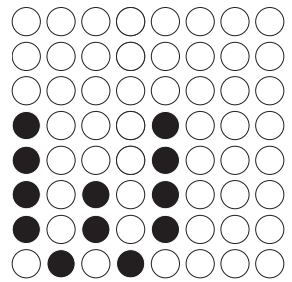

CHR119

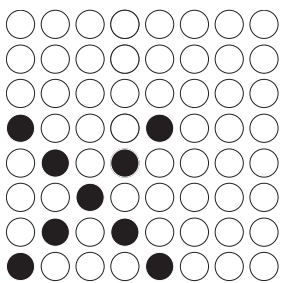

CHR120

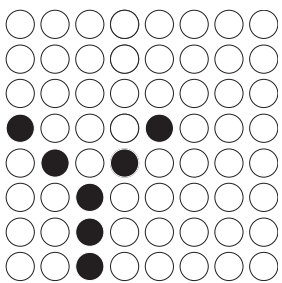

CHR121

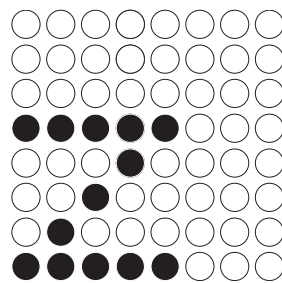

CHR122

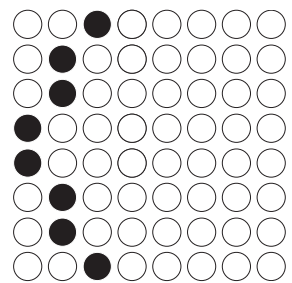

CHR123

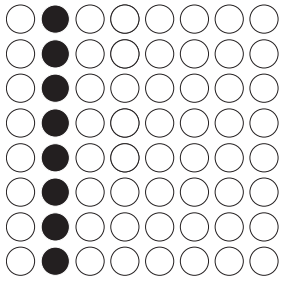

CHR124

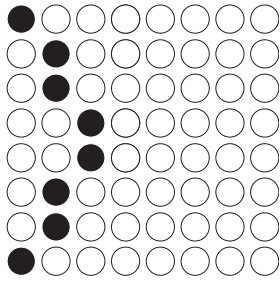

CHR125

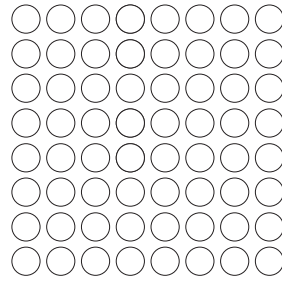

CHR126

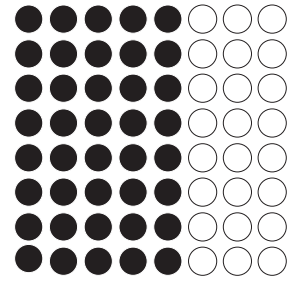

CHR127

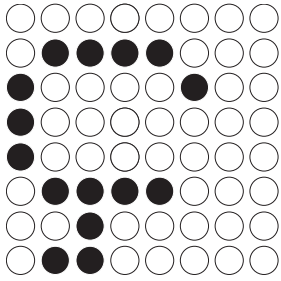

CHR128

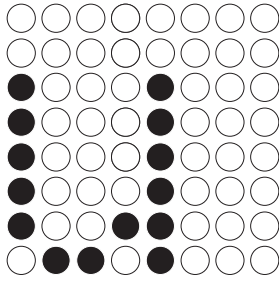

CHR129

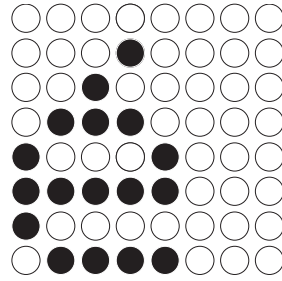

CHR130

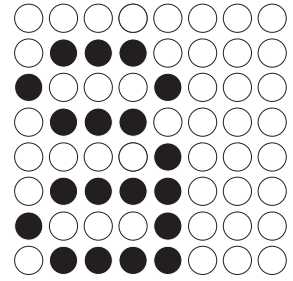

CHR131

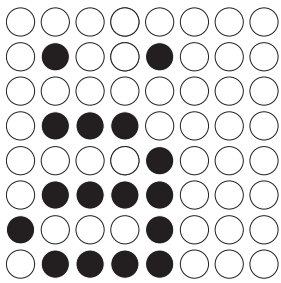

CHR132

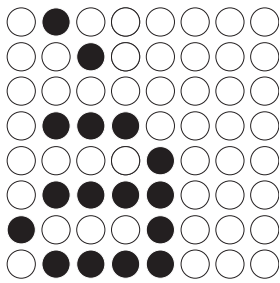

CHR133

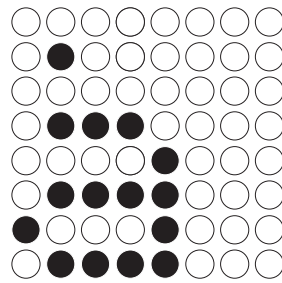

CHR134

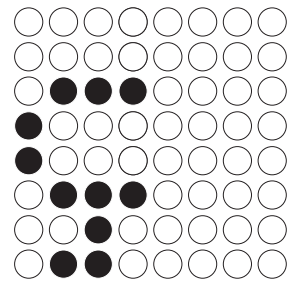

CHR135

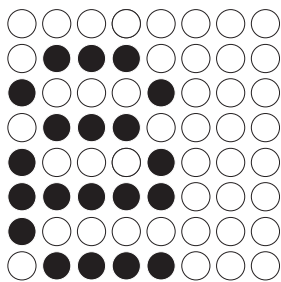

CHR136

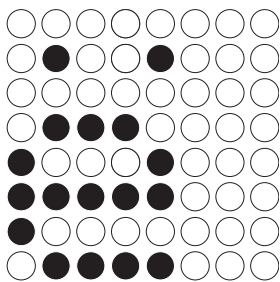

CHR137

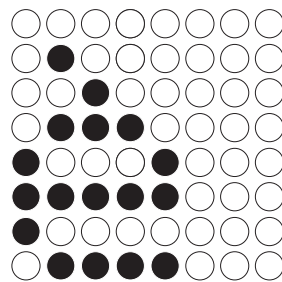

CHR138

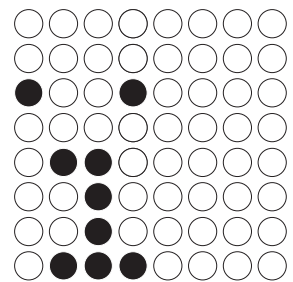

CHR139

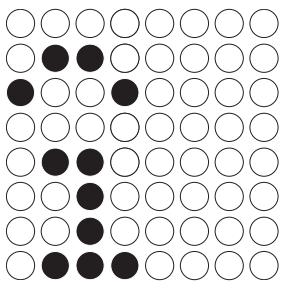

CHR140

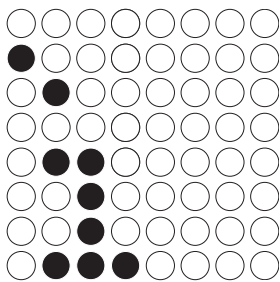

CHR141

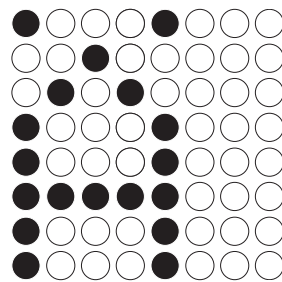

CHR142

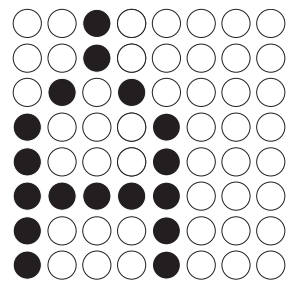

CHR143

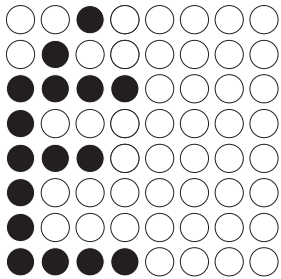

CHR144

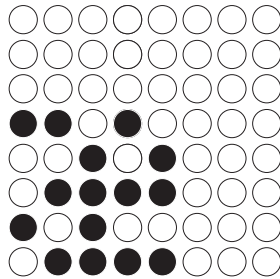

CHR145

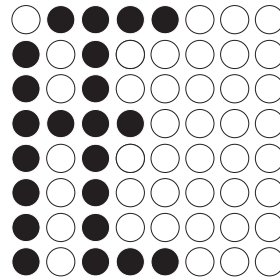

CHR146

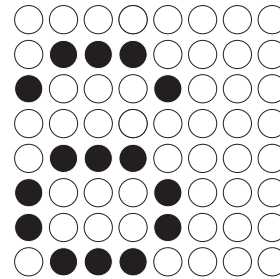

CHR147

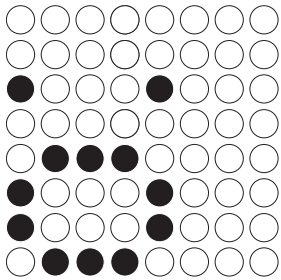

CHR148

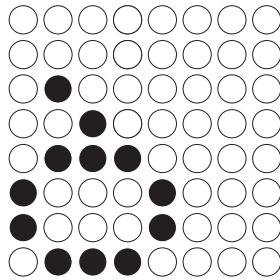

CHR149

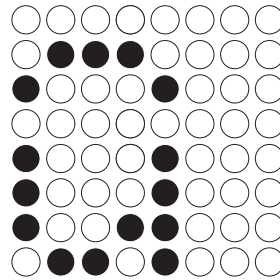

CHR150

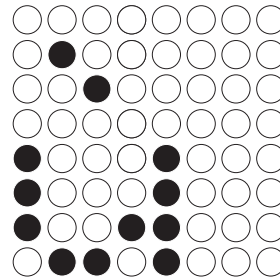

CHR151

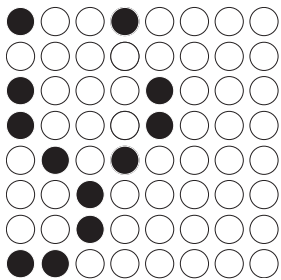

CHR152

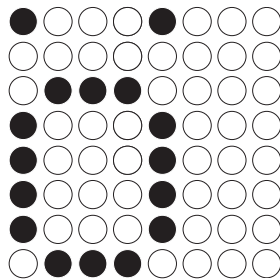

CHR153

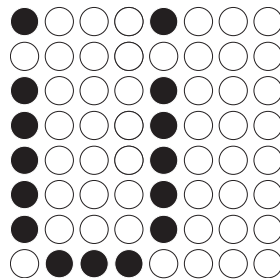

CHR154

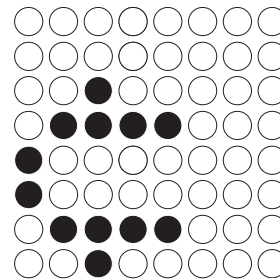

CHR155

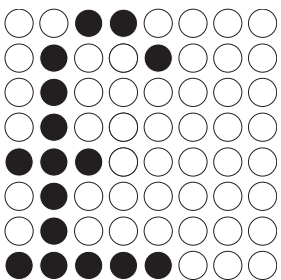

CHR156

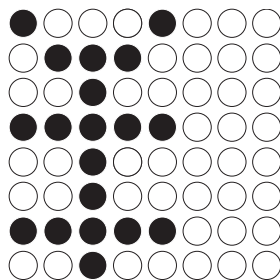

CHR157

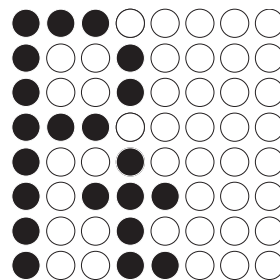

CHR158

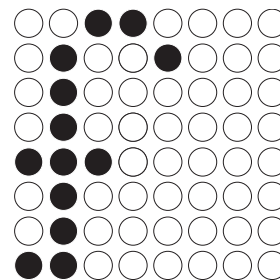

CHR159

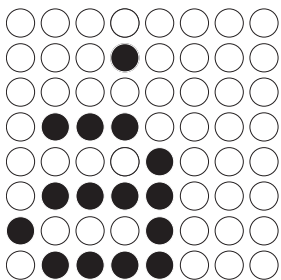

CHR160

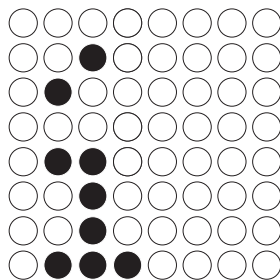

CHR161

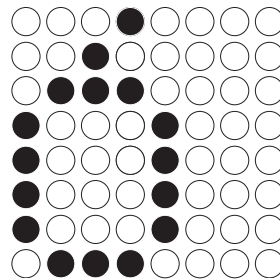

CHR162

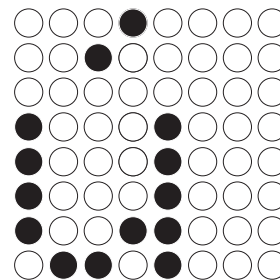

CHR163

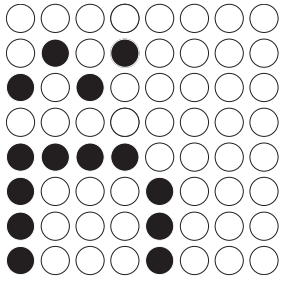

CHR164

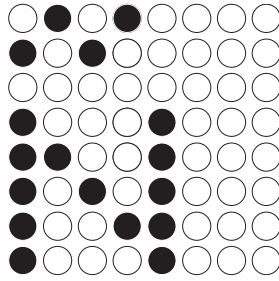

CHR165

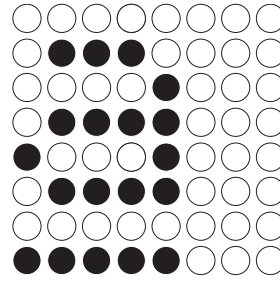

CHR166

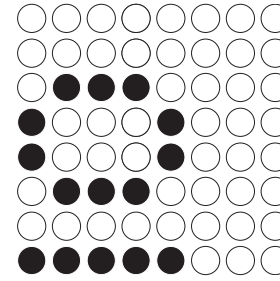

CHR167

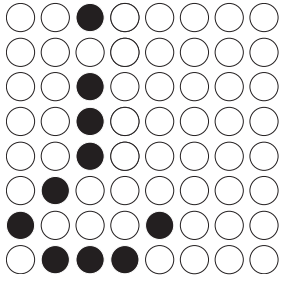

CHR168

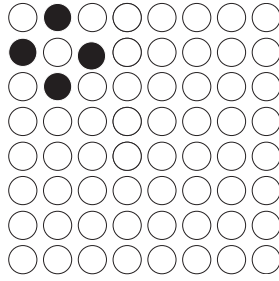

CHR169

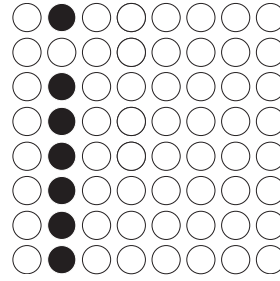

CHR170

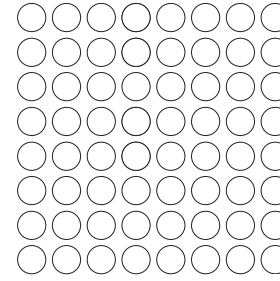

CHR171

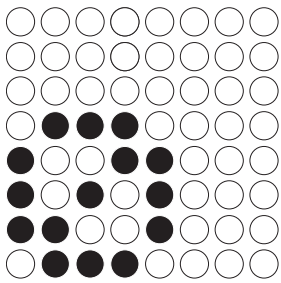

CHR172

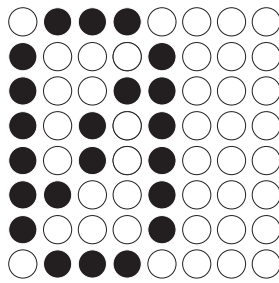

CHR173

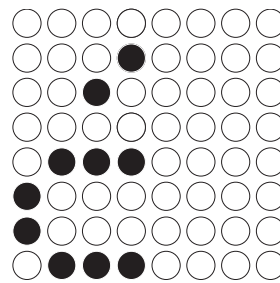

CHR174

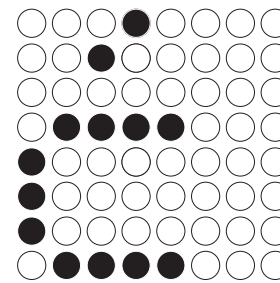

CHR175

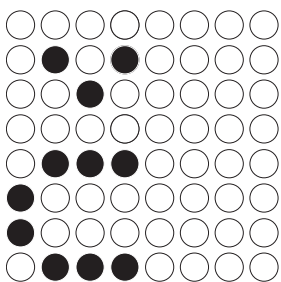

CHR176

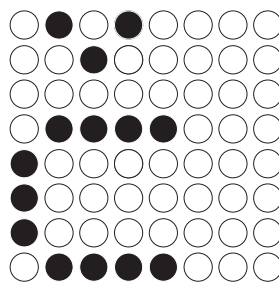

CHR177

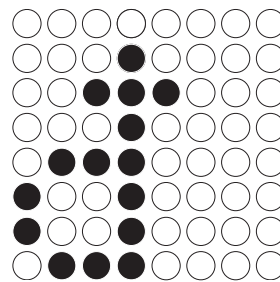

CHR178

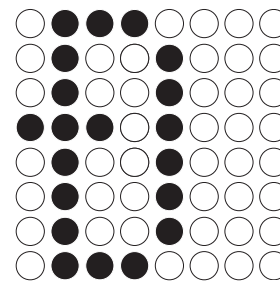

CHR179

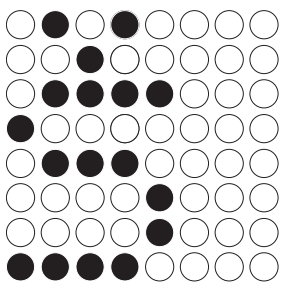

CHR180

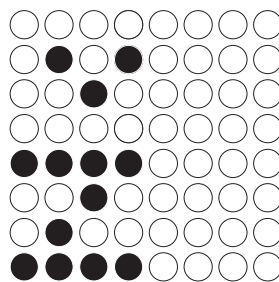

CHR181

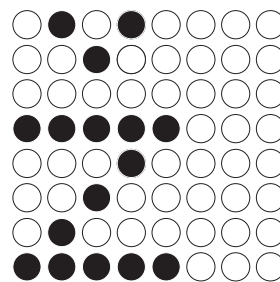

CHR182

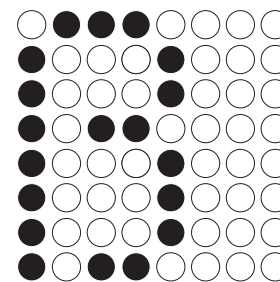

CHR183

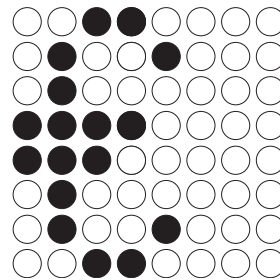
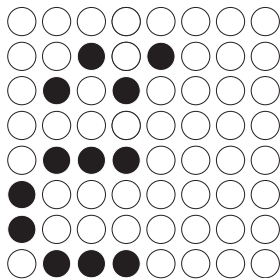
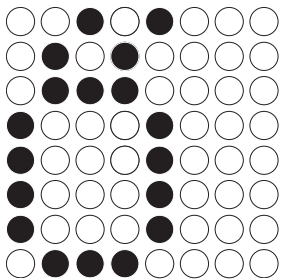
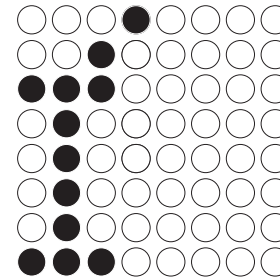
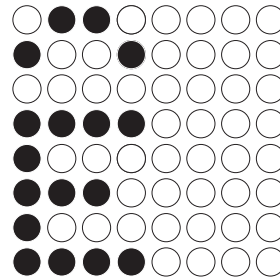
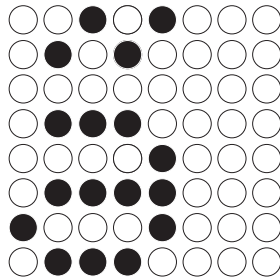
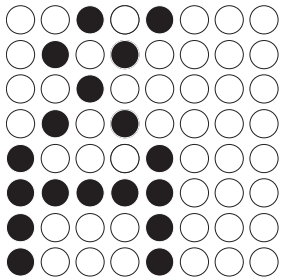
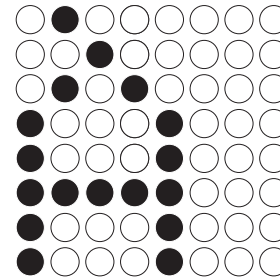
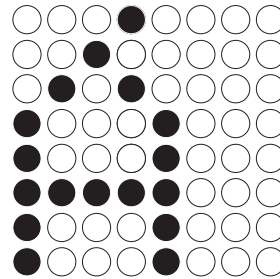
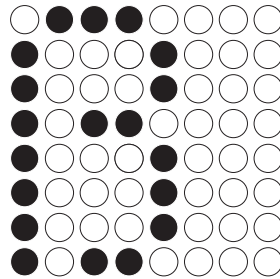
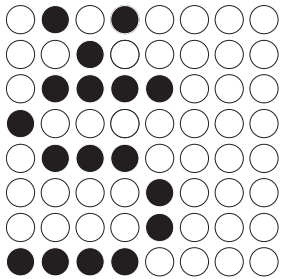

**7.15.8 8-High Fancy (SF8)**

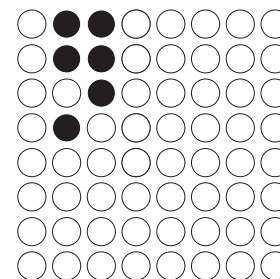
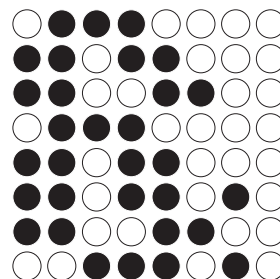
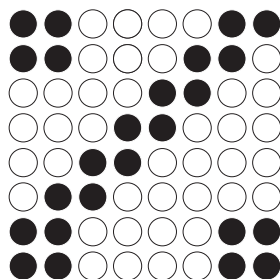
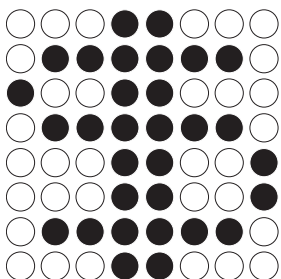
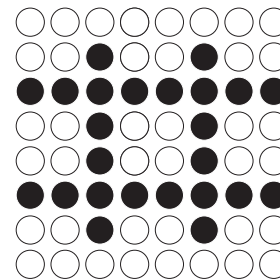
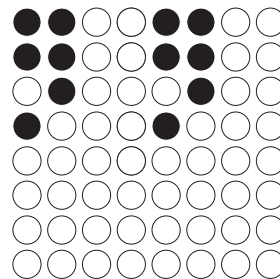
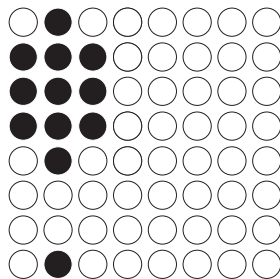
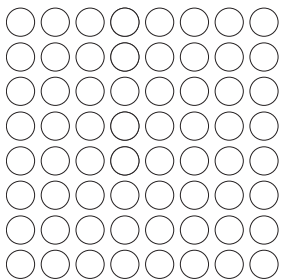



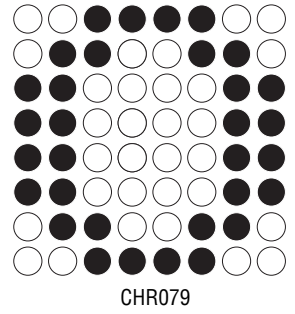
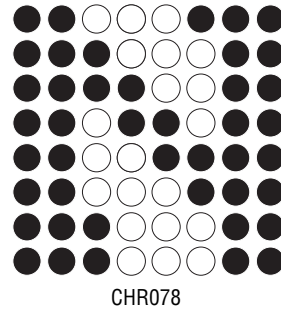
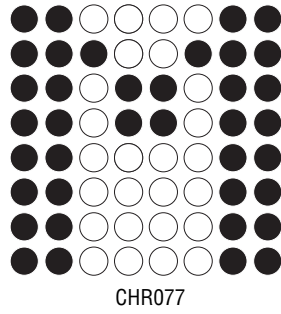
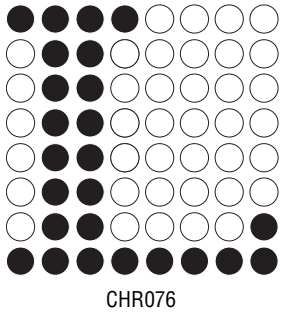
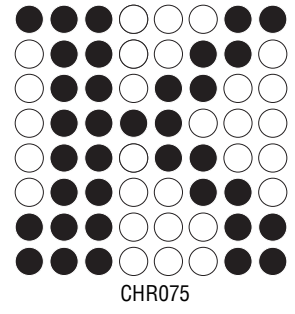
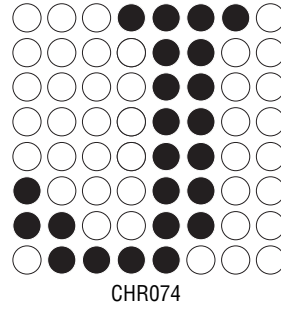
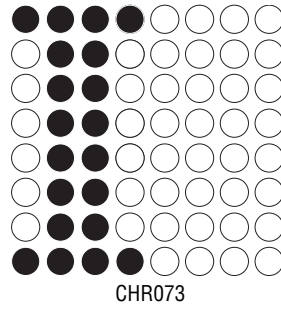
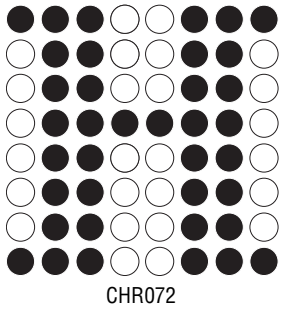
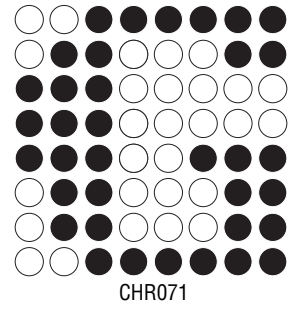
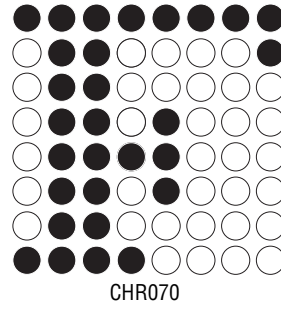
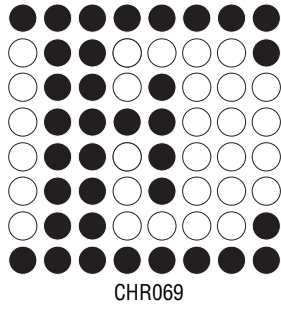
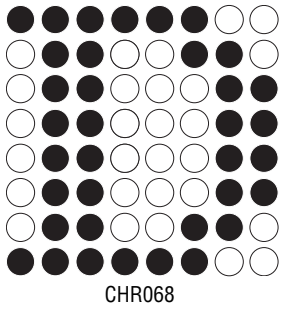
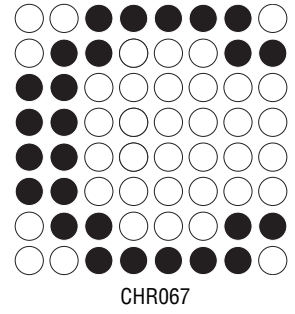
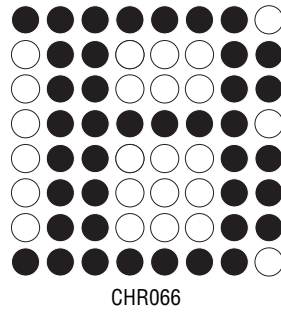
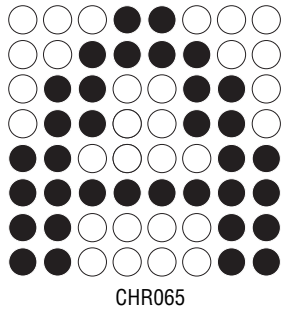
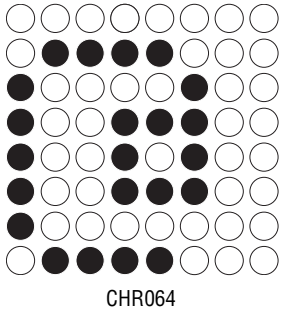
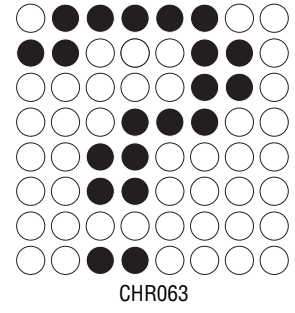
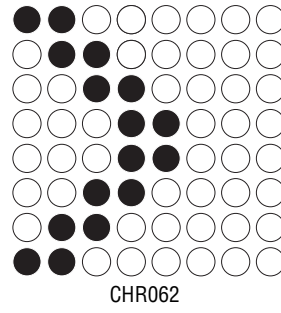
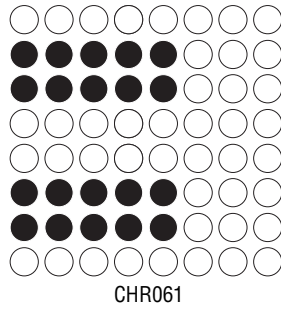
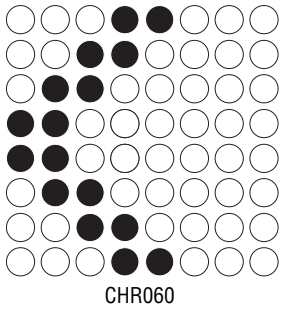





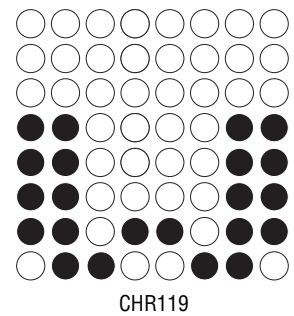
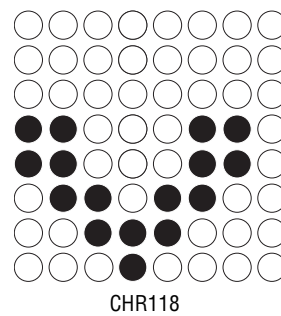
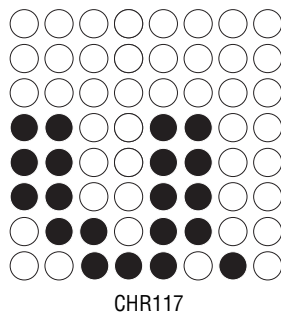
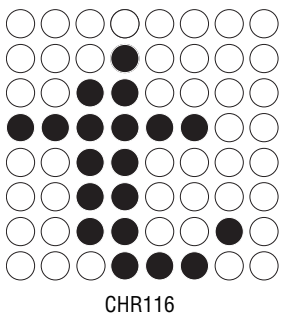
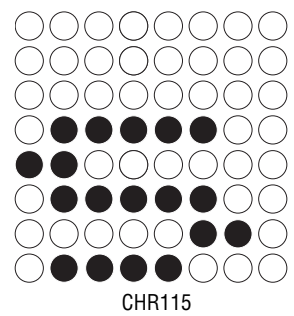
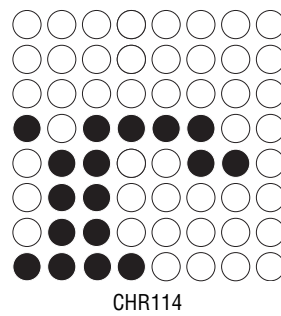
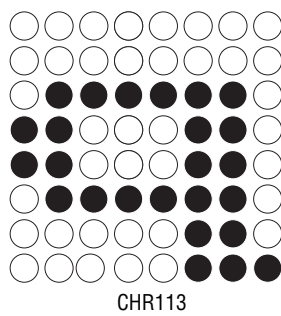
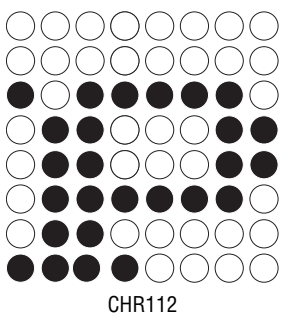
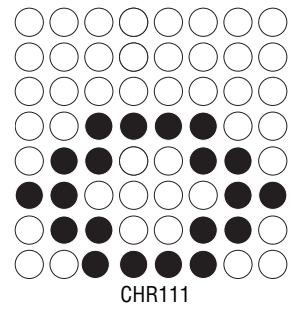
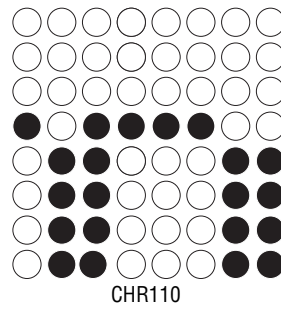
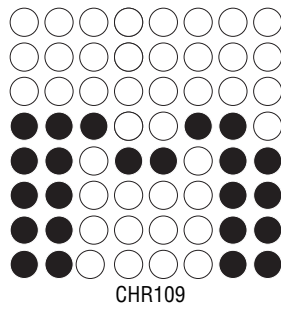
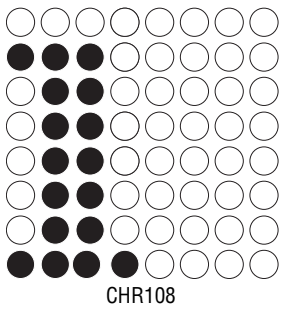
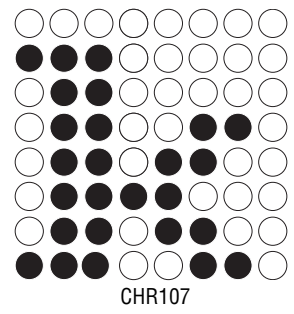
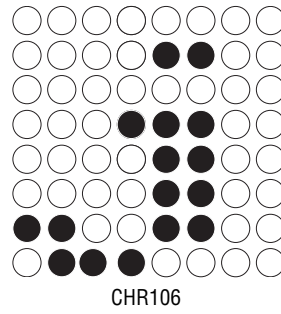
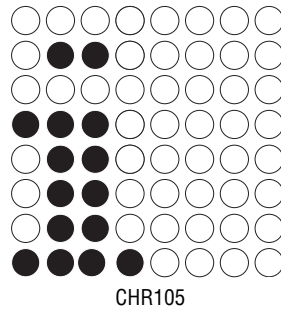
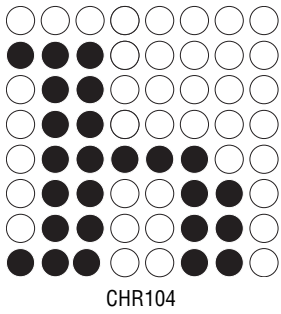
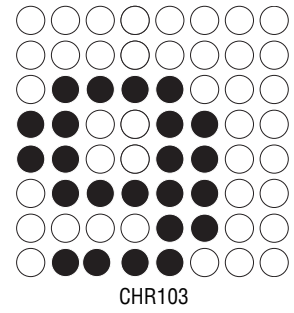
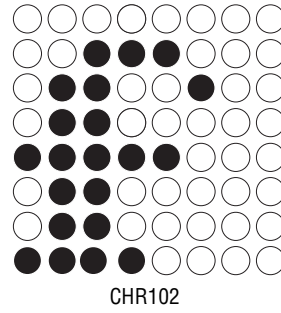
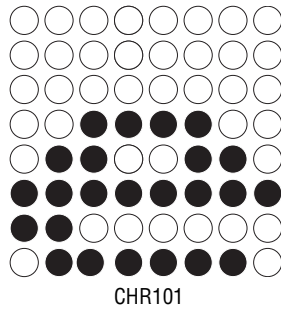
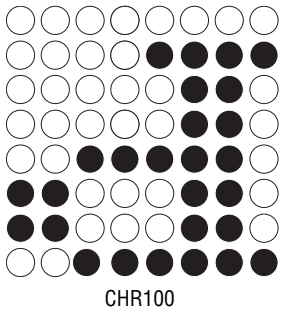



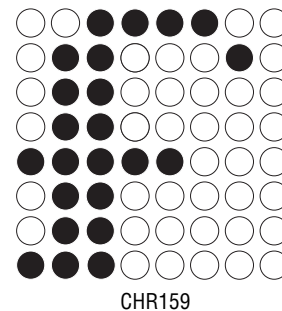
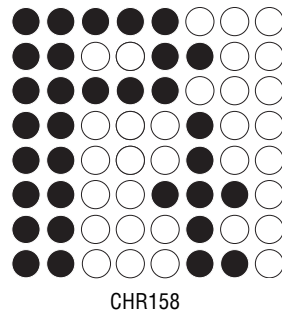
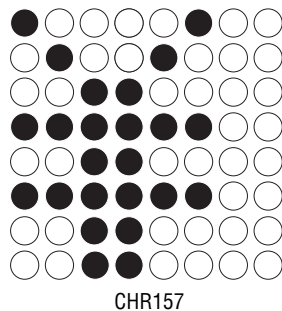
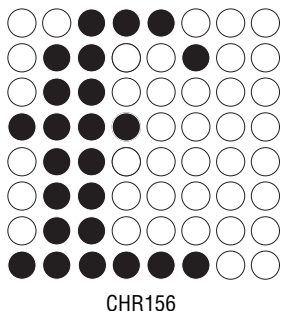
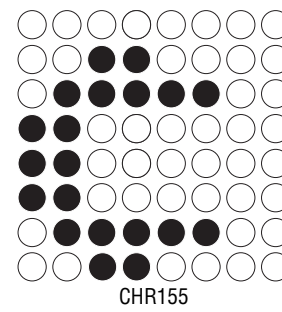
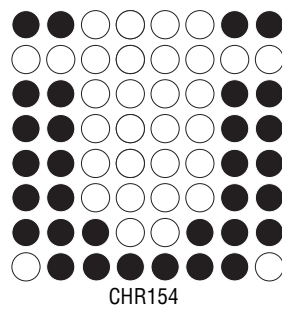
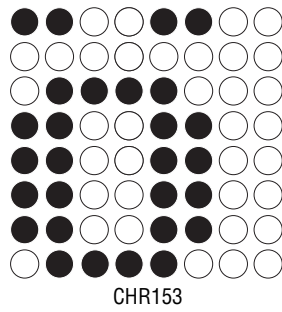
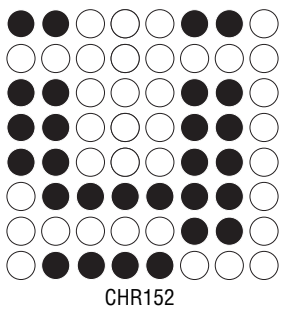
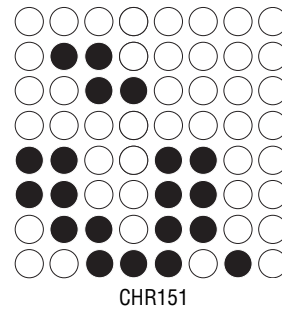
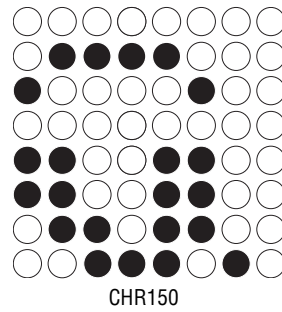
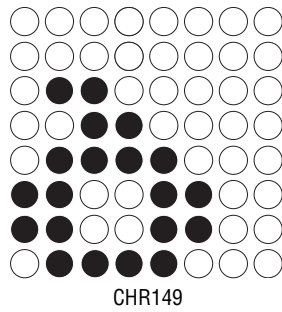
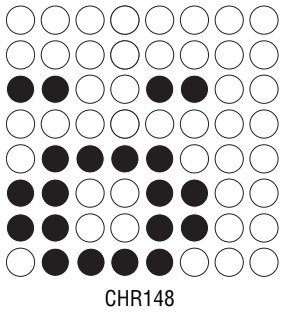
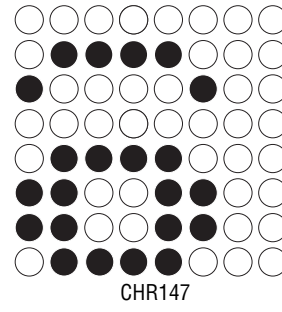
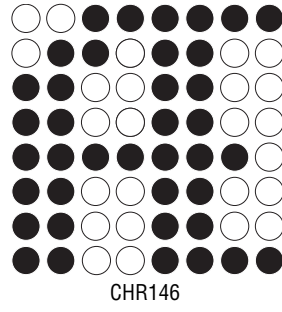
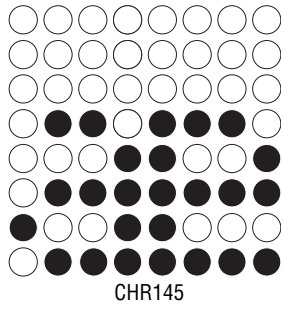
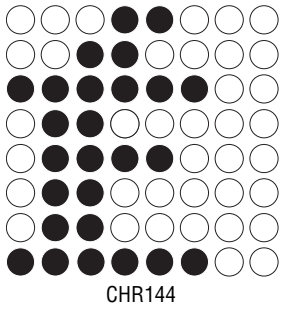
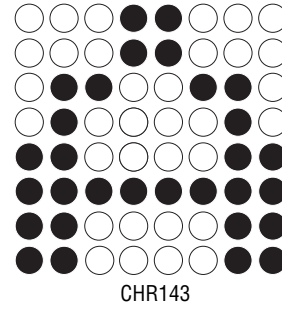
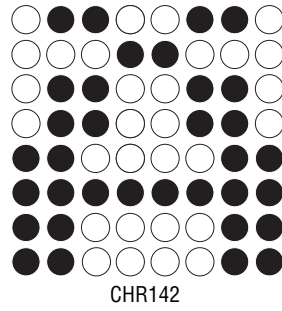
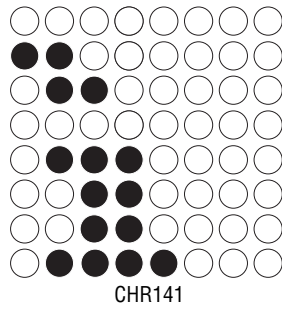
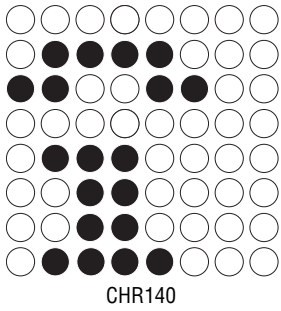

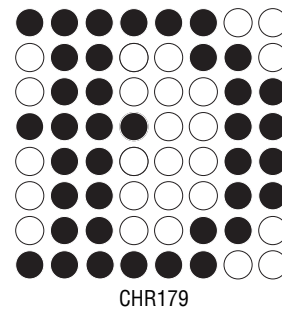
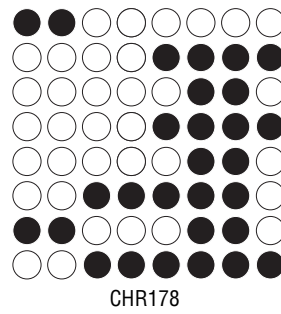
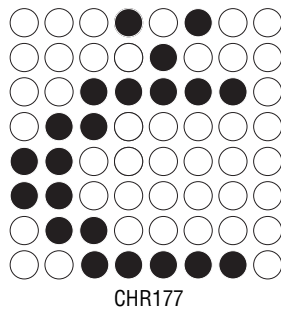
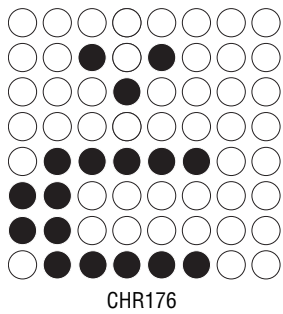
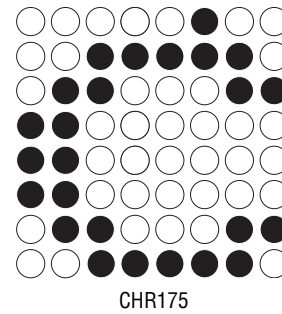
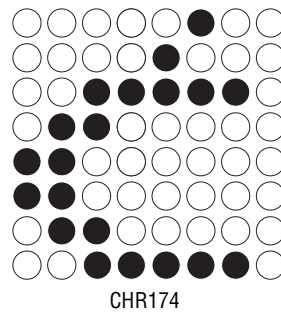
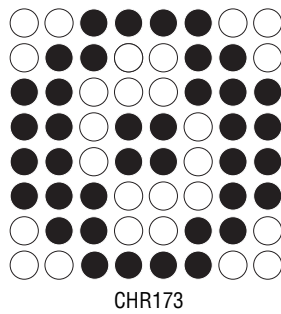
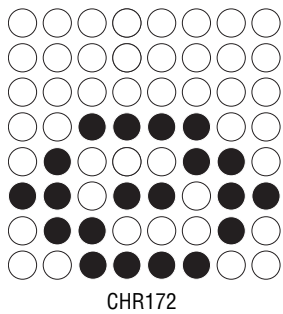
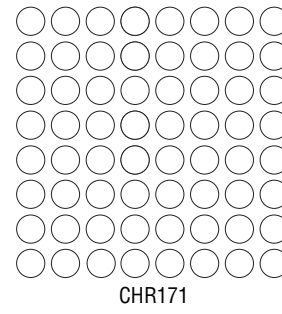
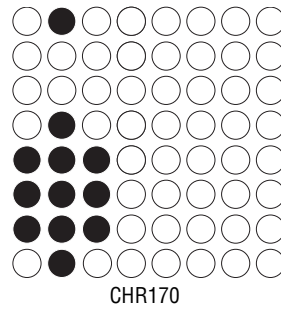
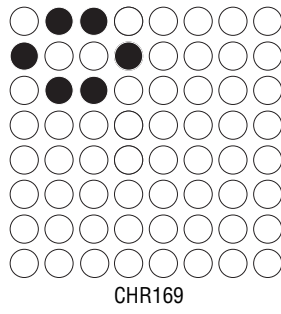
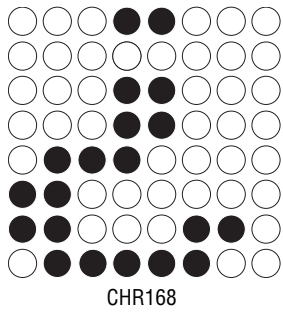
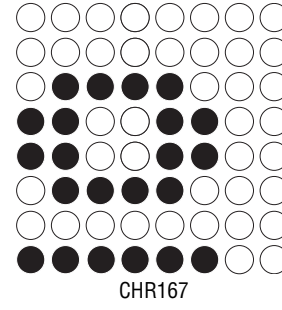
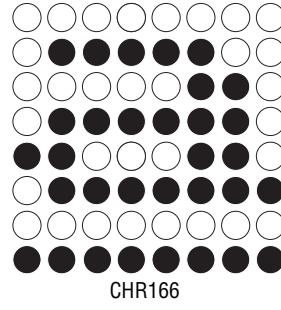
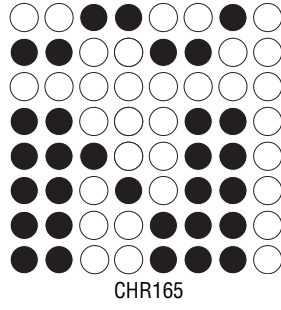
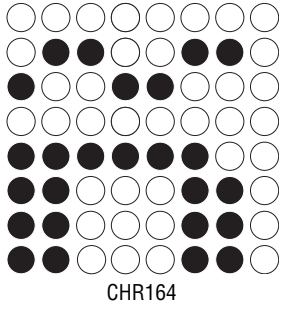
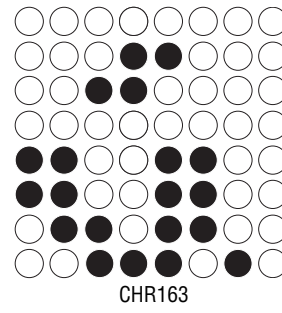
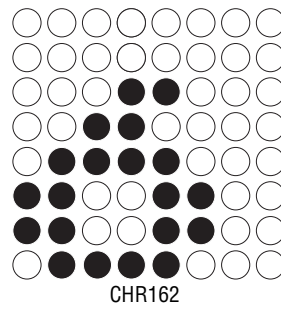
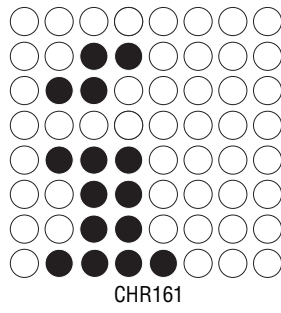
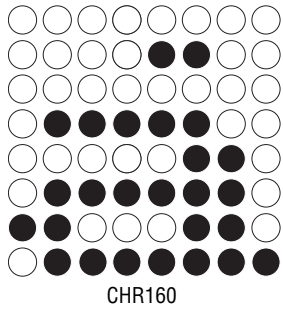

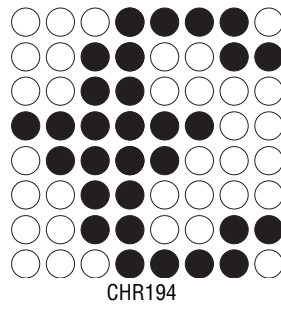
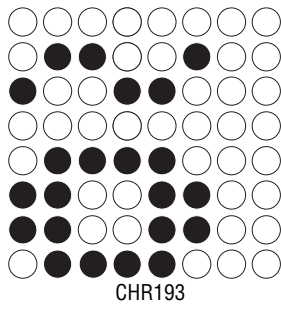
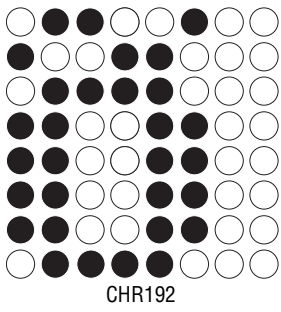
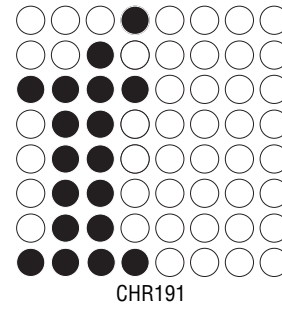
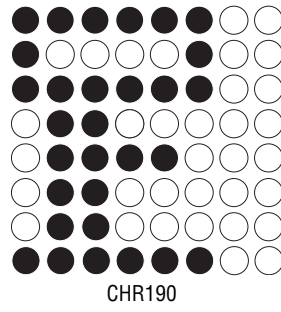
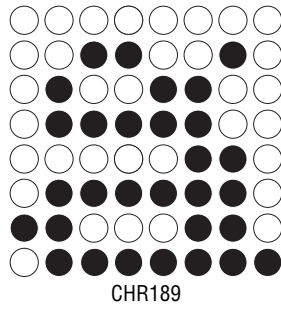
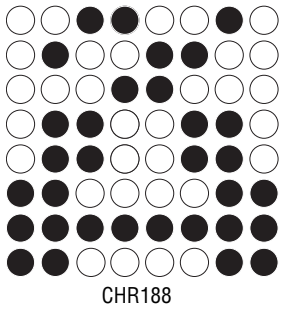
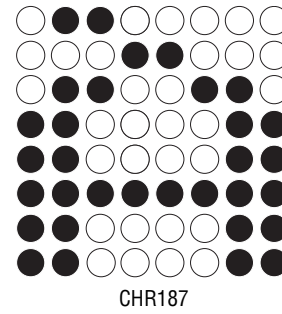
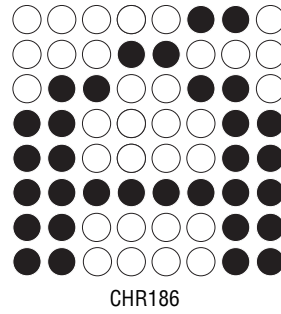
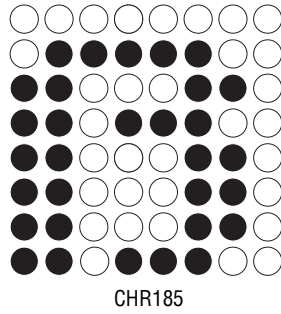
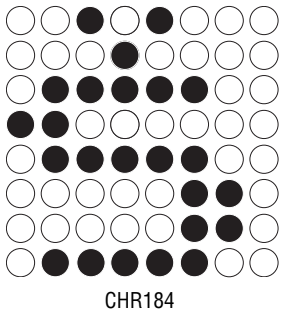
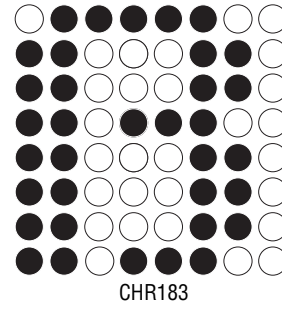
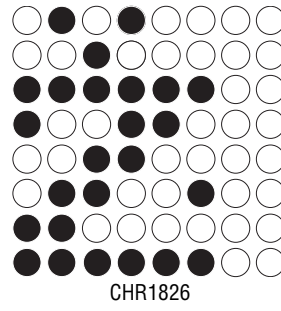
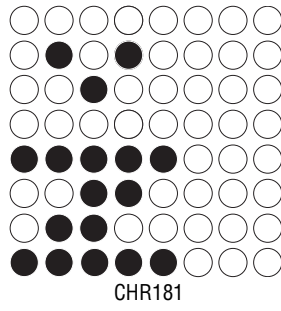
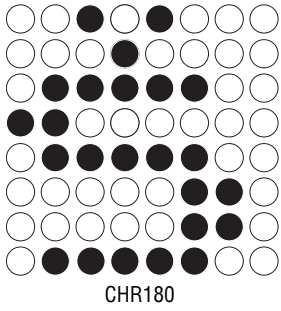

7.15.9 10-High Fancy (SF10)

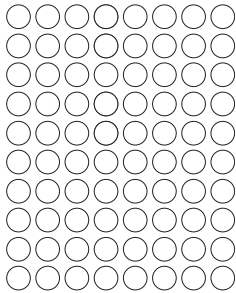

CHR032

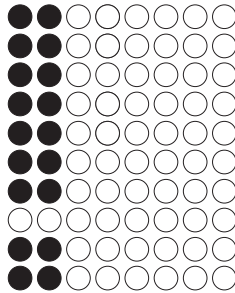

CHR033

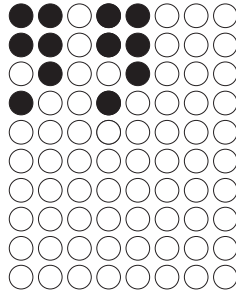

CHR034

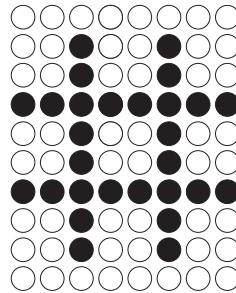

CHR035

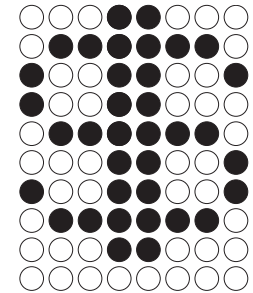

CHR036

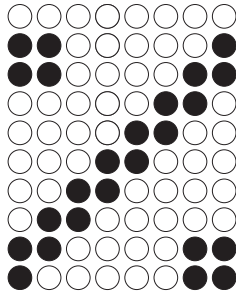

CHR037

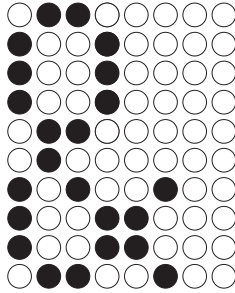

CHR038

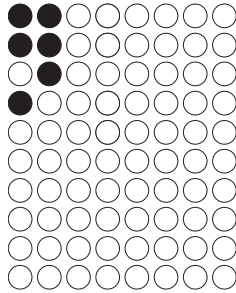

CHR039

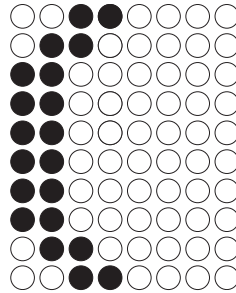

CHR040

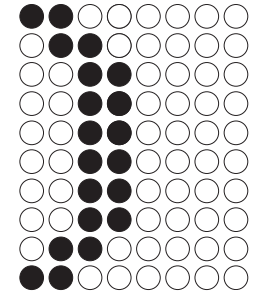

CHR041

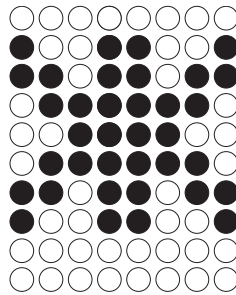

CHR042

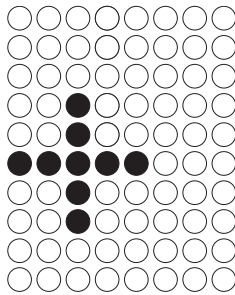

CHR043

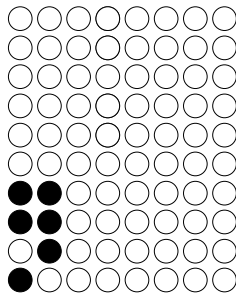

CHR044

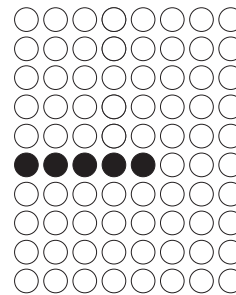

CHR045

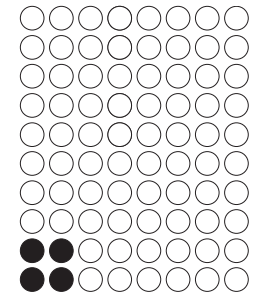

CHR046

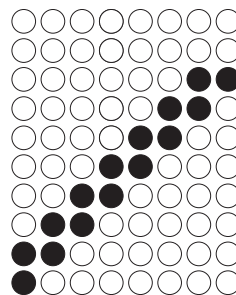

CHR047

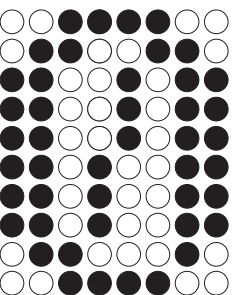

CHR048

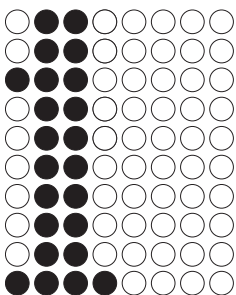

CHR049

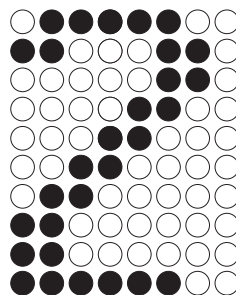

CHR050

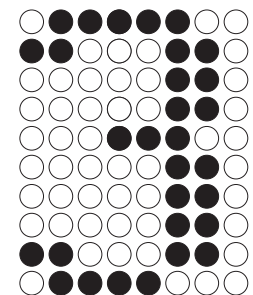

CHR051

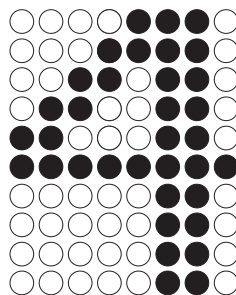

CHR052

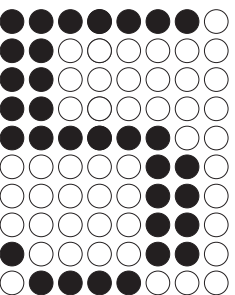

CHR053

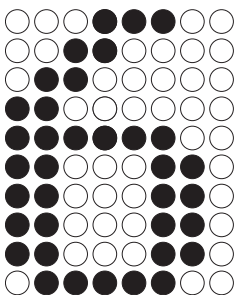

CHR054

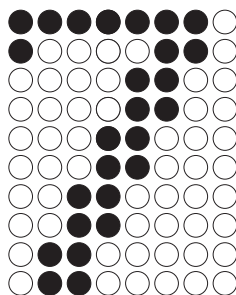

CHR055

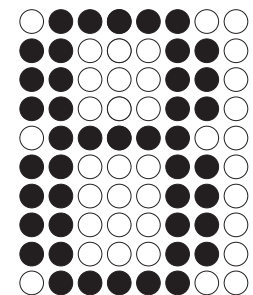

CHR056





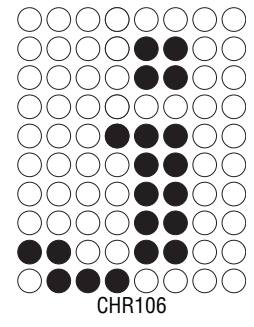
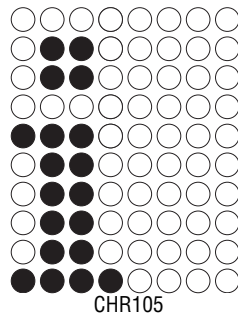
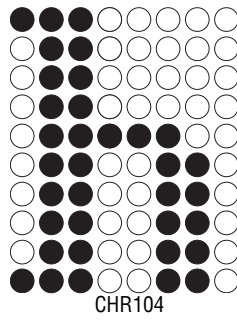
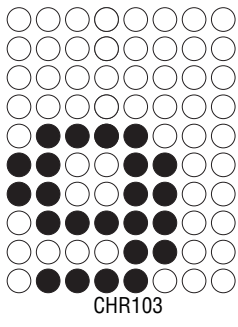
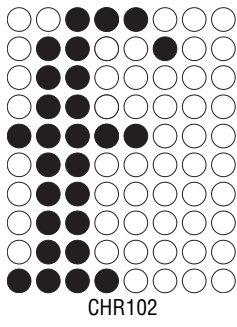
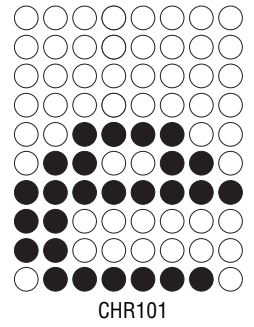
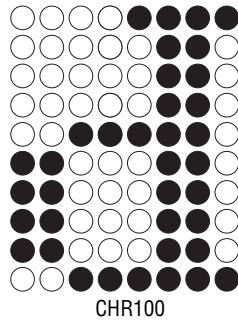
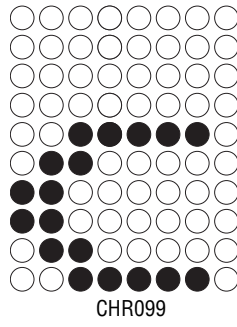
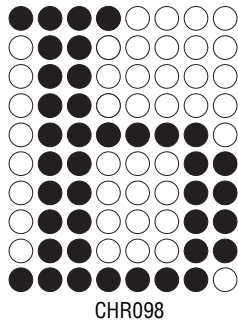
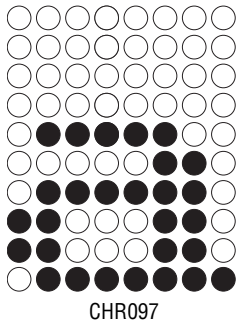
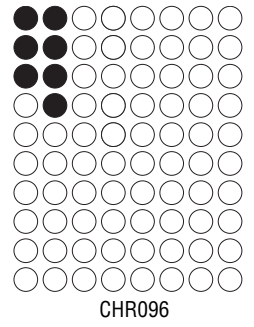
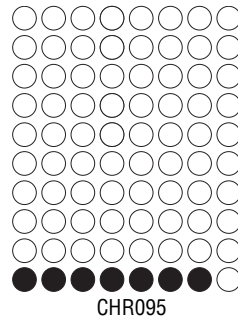
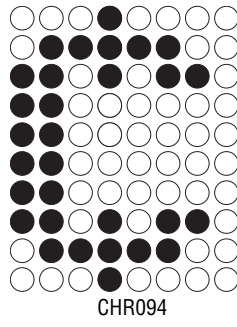
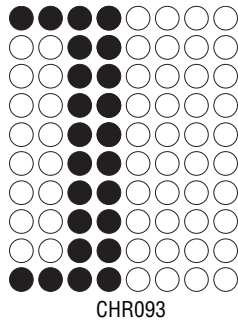
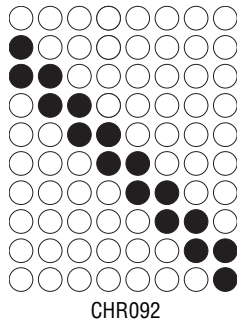
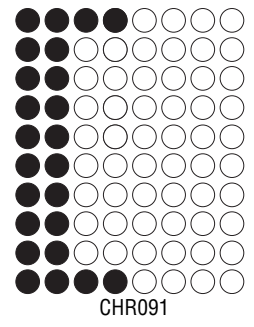
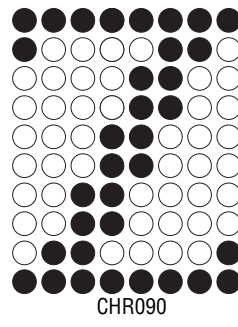
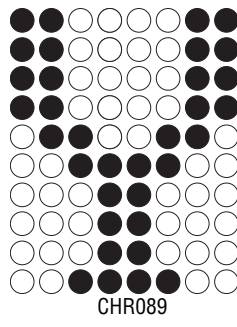
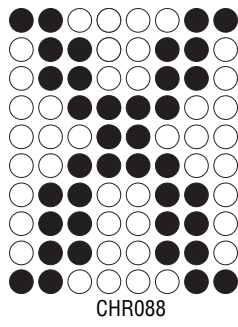
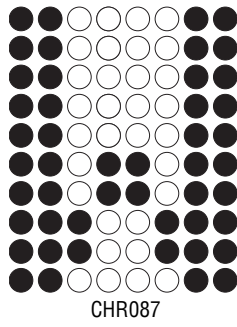
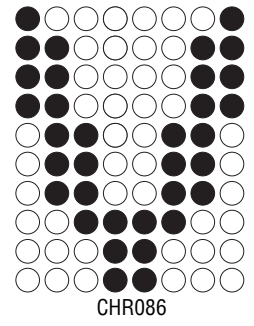
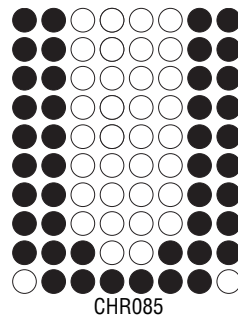
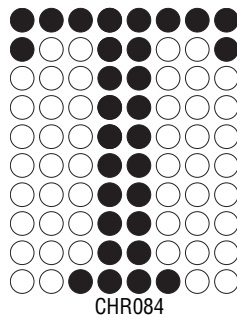
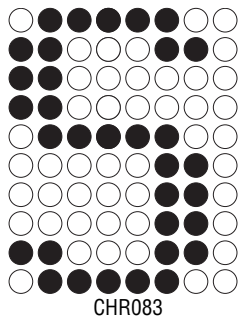
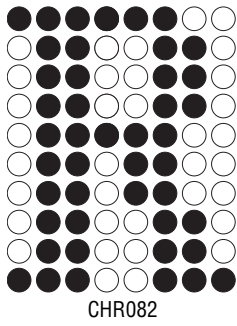



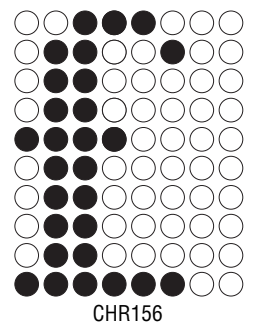
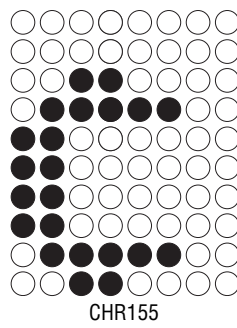
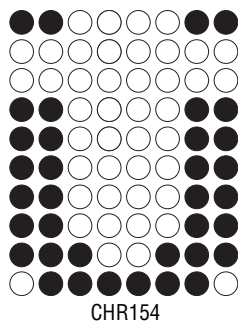
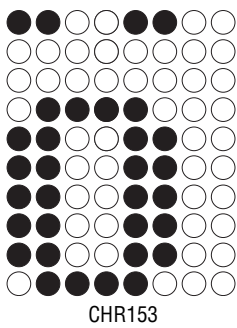
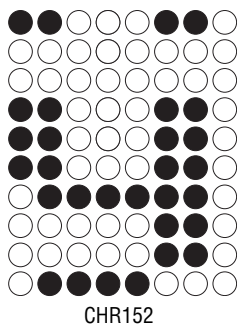
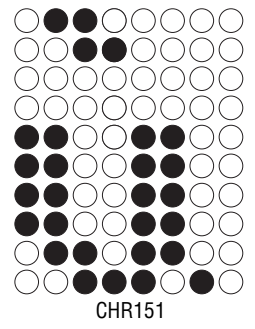
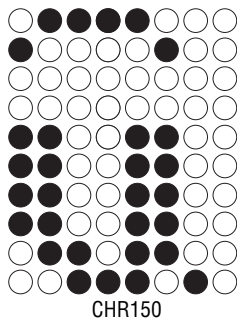
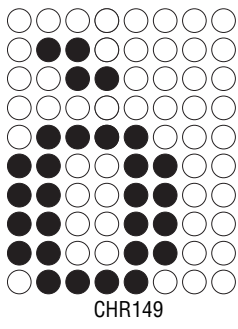
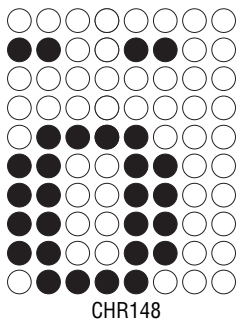
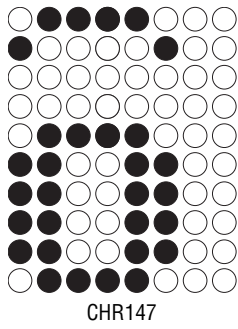
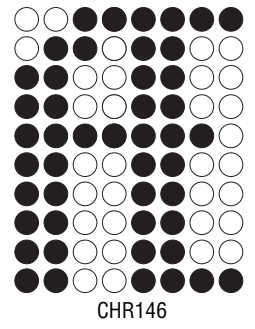
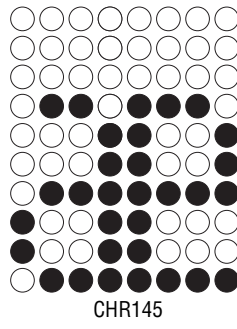
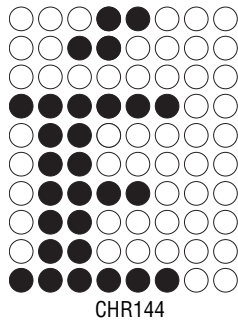
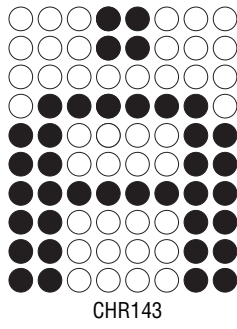
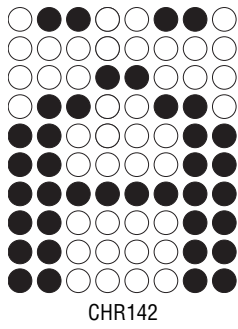
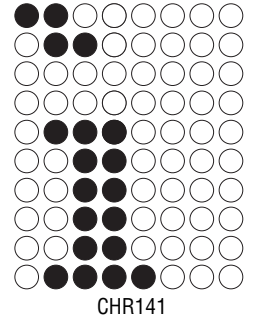
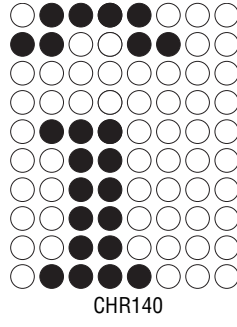
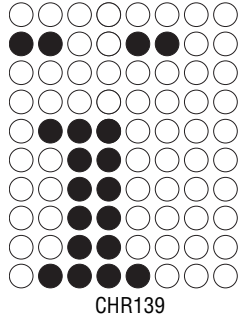
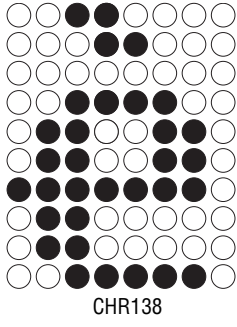
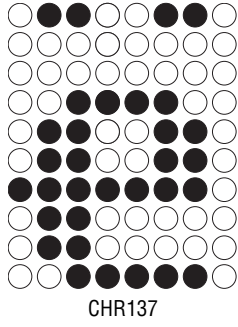
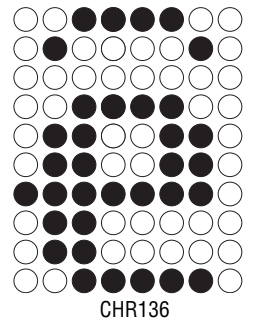
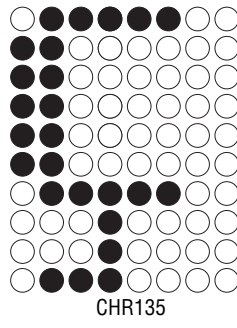
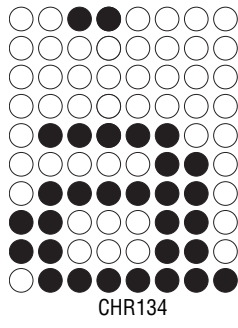
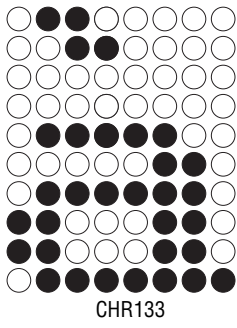
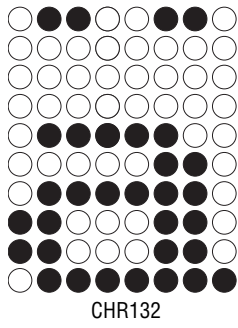

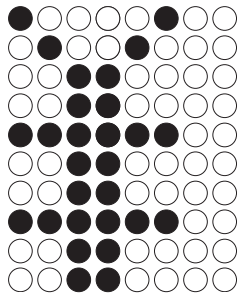

CHR157

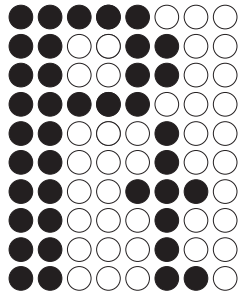

CHR158

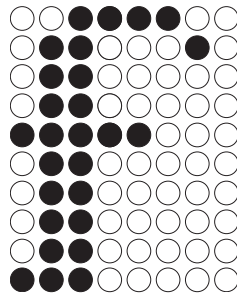

CHR159

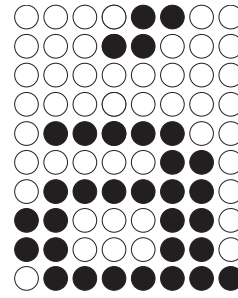

CHR160

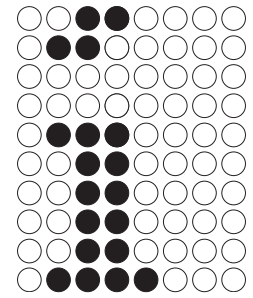

CHR161

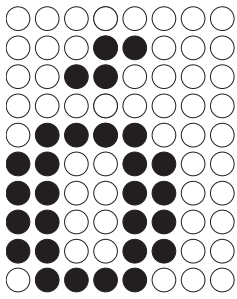

CHR162

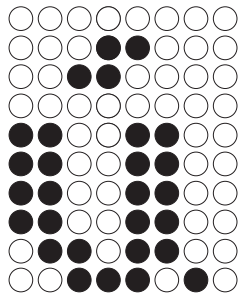

CHR163

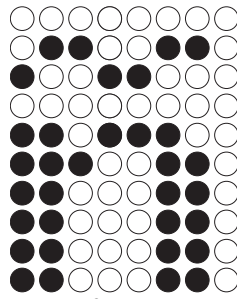

CHR164

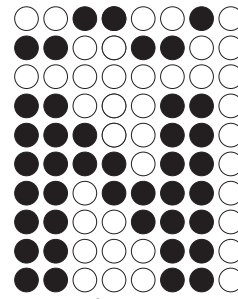

CHR165

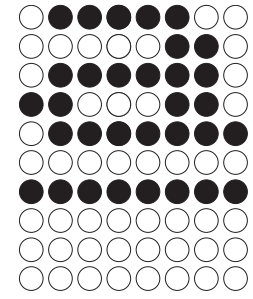

CHR166

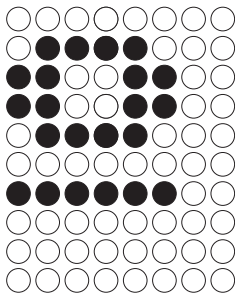

CHR167

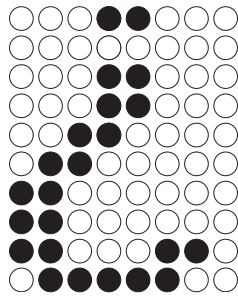

CHR168

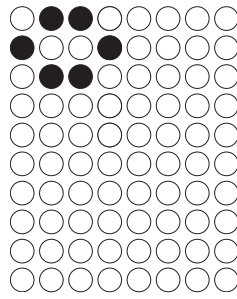

CHR169

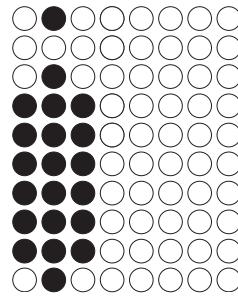

CHR170

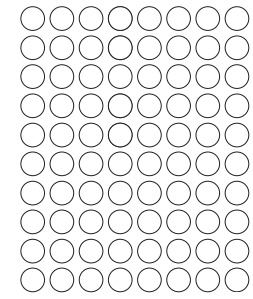

CHR171

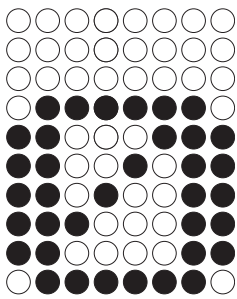

CHR172

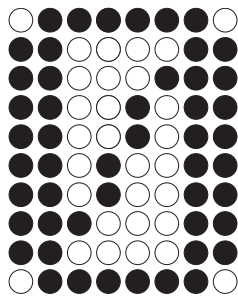

CHR173

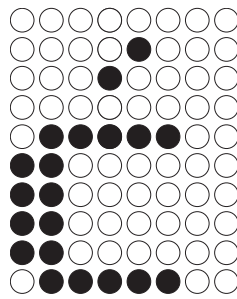

CHR174

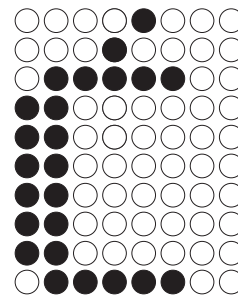

CHR175

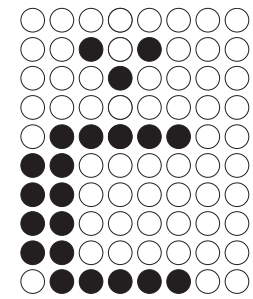

CHR176

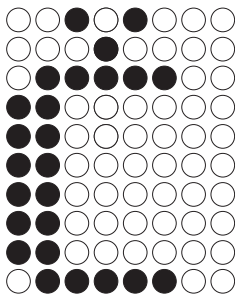

CHR177

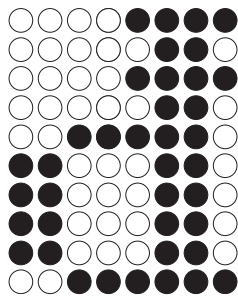

CHR178

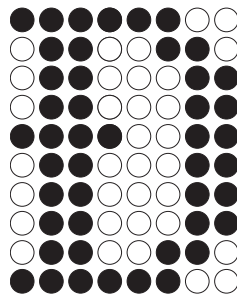

CHR179

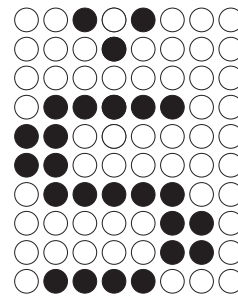

CHR180

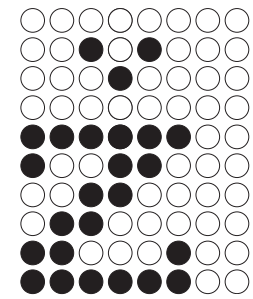

CHR181



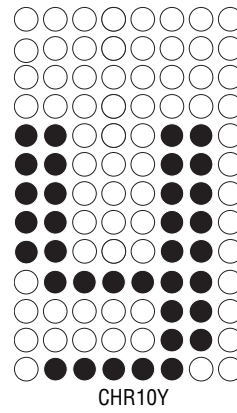
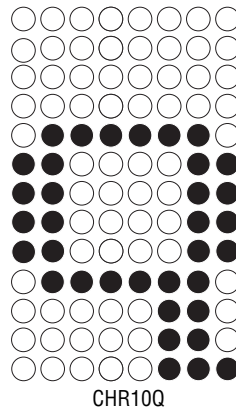
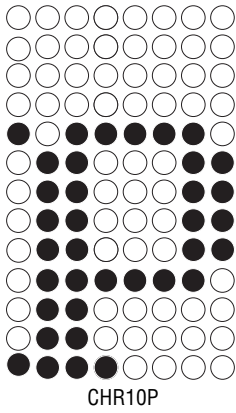

**7.15.11 15-High Regular (SS15)**

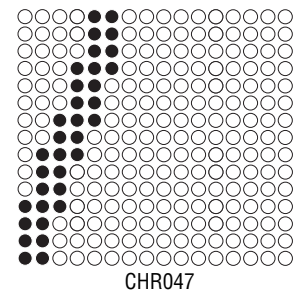
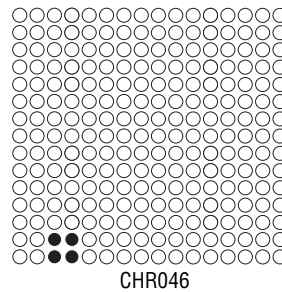
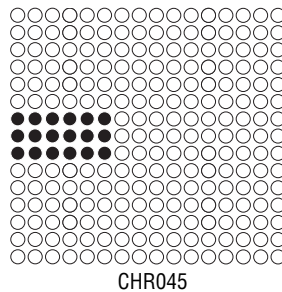
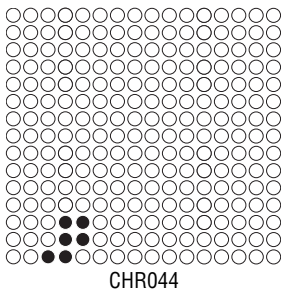
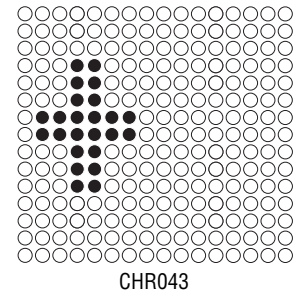
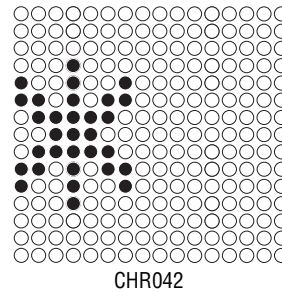
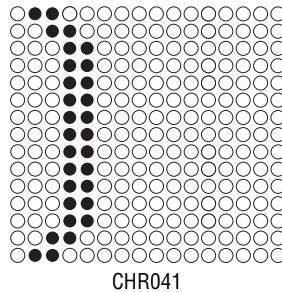
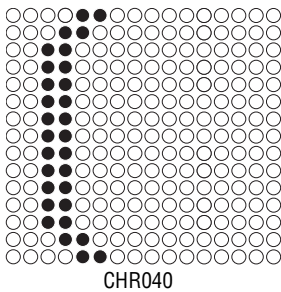
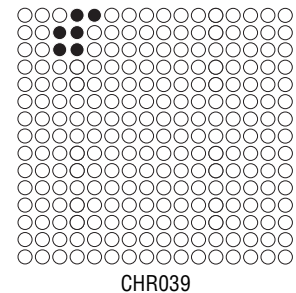
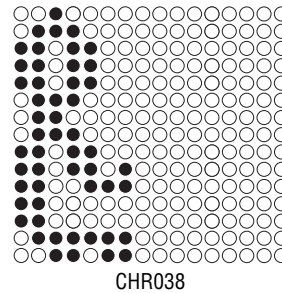
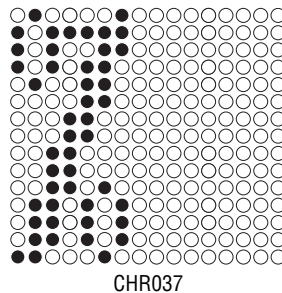
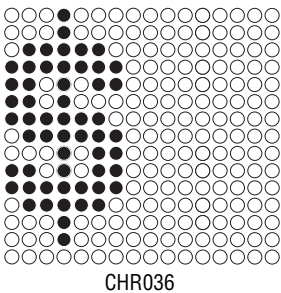
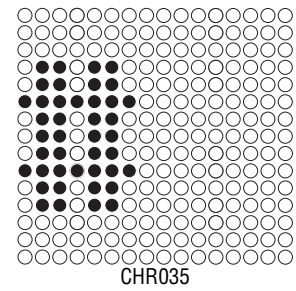
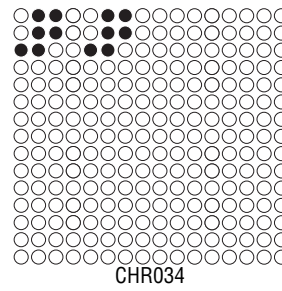
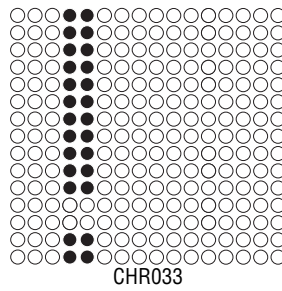
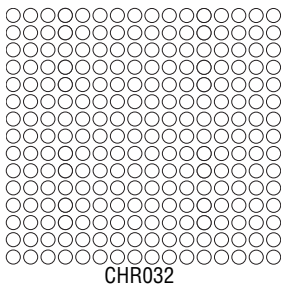

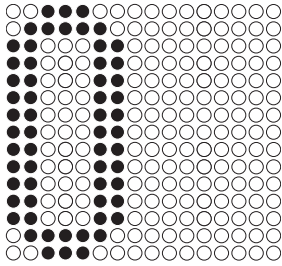

CHR048

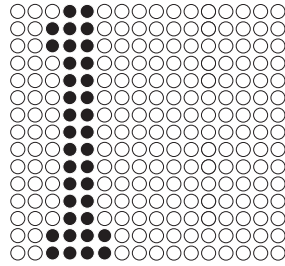

CHR049

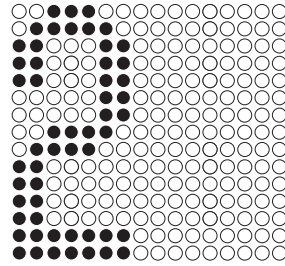

CHR050

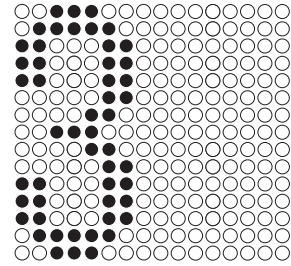

CHR051

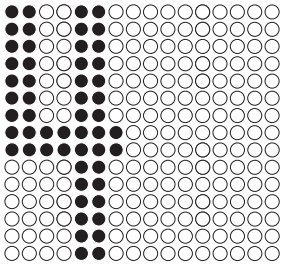

CHR052

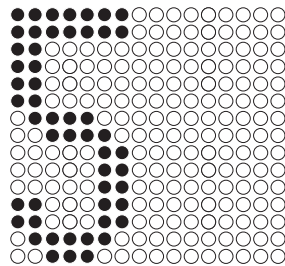

CHR053

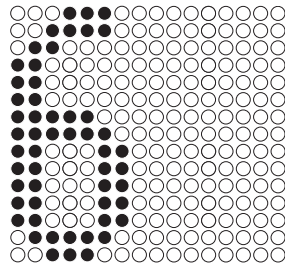

CHR054

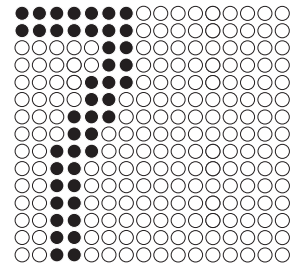

CHR055

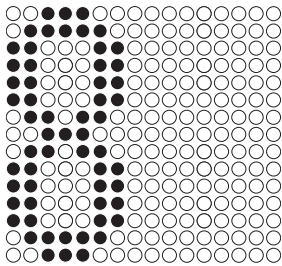

CHR056

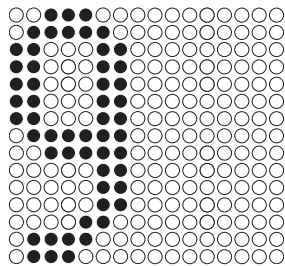

CHR057

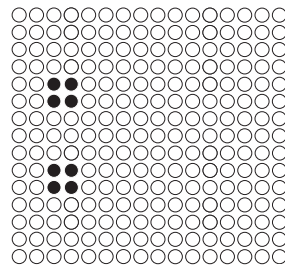

CHR058

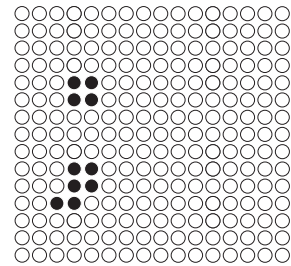

CHR059

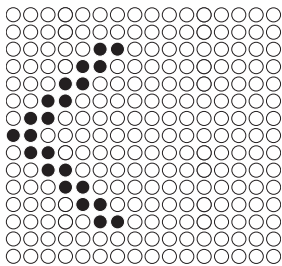

CHR060

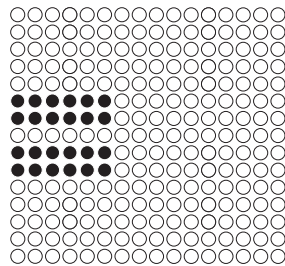

CHR061

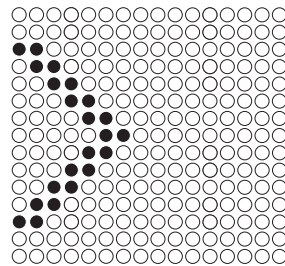

CHR062

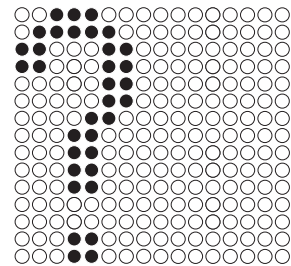

CHR063

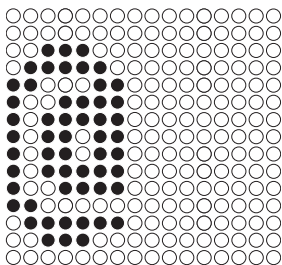

CHR064

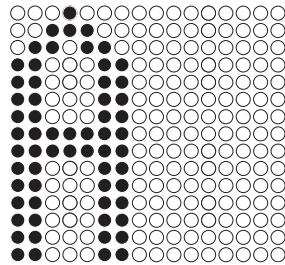

CHR065

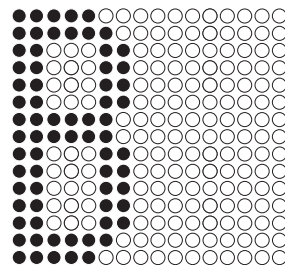

CHR066

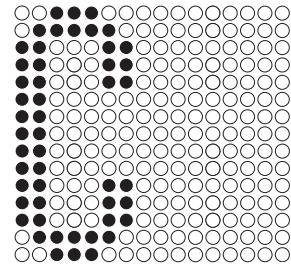

CHR067

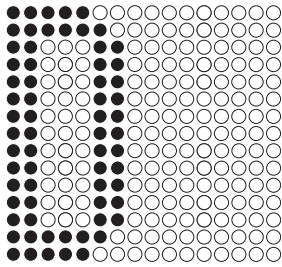

CHR068

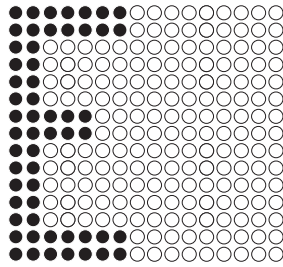

CHR069

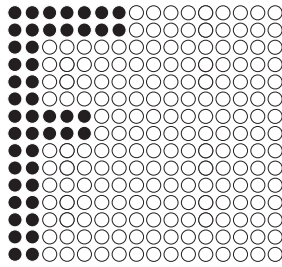

CHR070

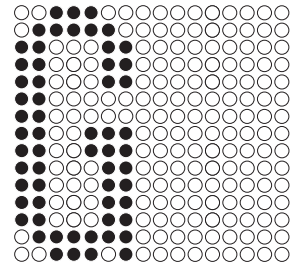

CHR071

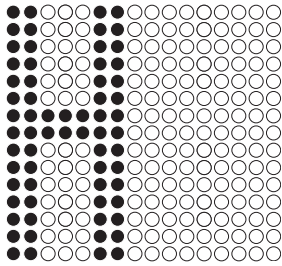

CHR072

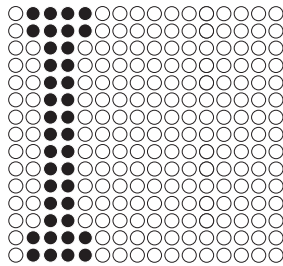

CHR073

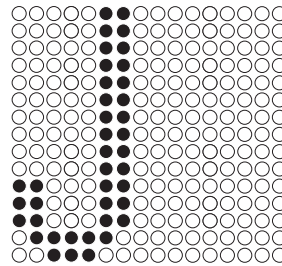

CHR074

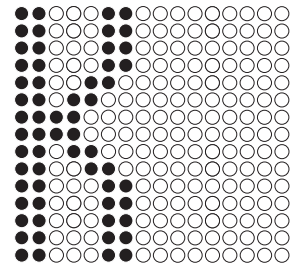

CHR075

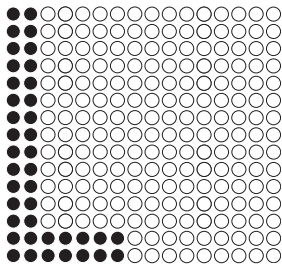

CHR076

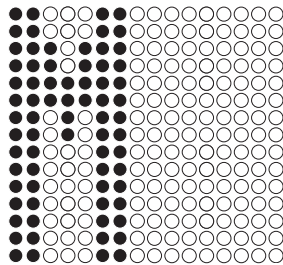

CHR077

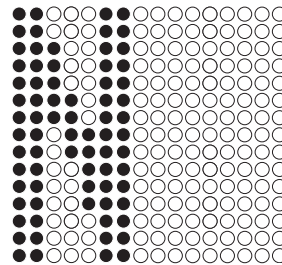

CHR078

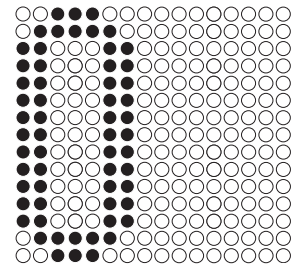

CHR079

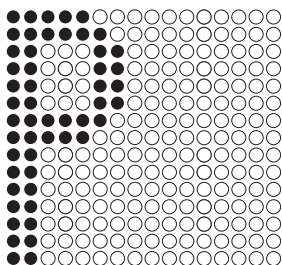

CHR080

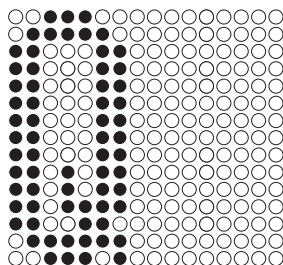

CHR081

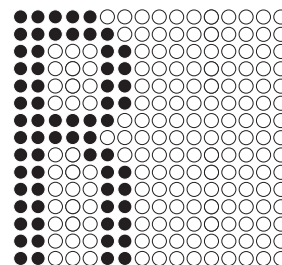

CHR082

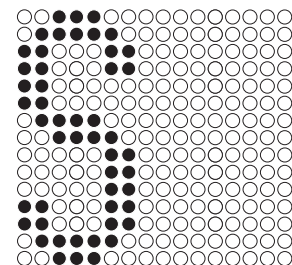

CHR083

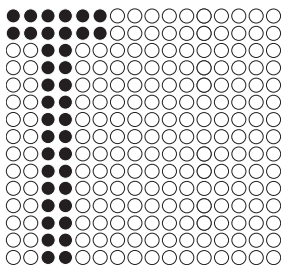

CHR084

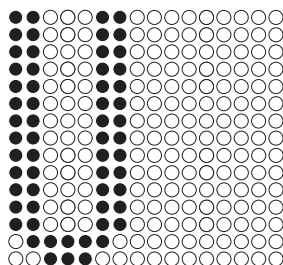

CHR085

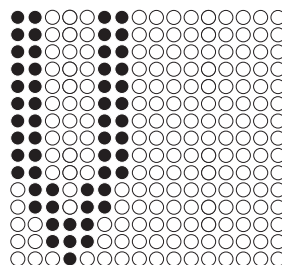

CHR086

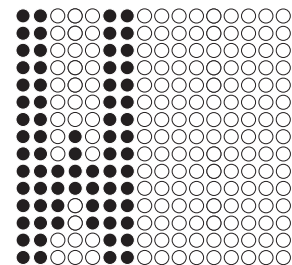

CHR087





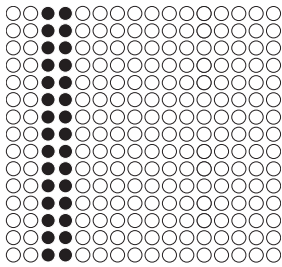

CHR108

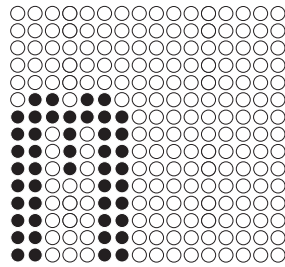

CHR109

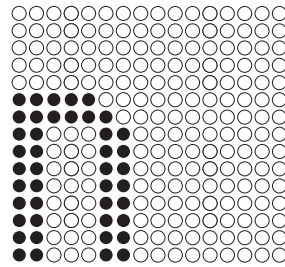

CHR110

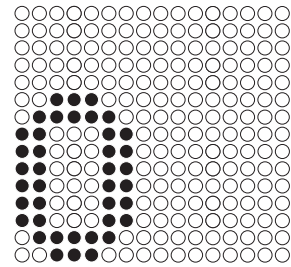

CHR111

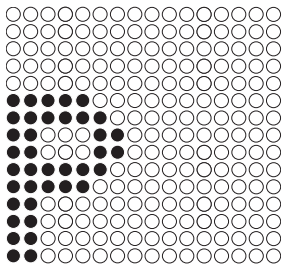

CHR112

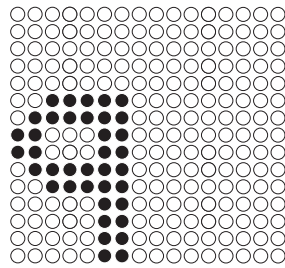

CHR113

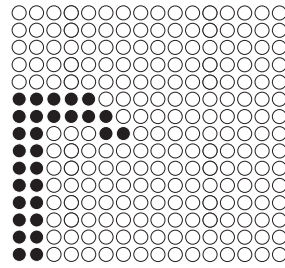

CHR114

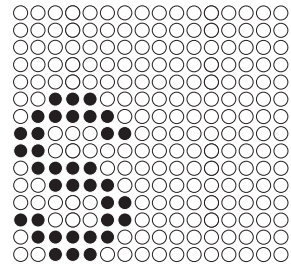

CHR115

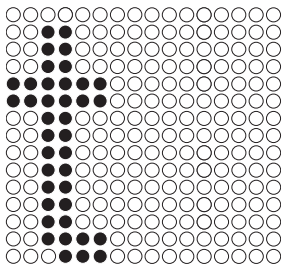

CHR116

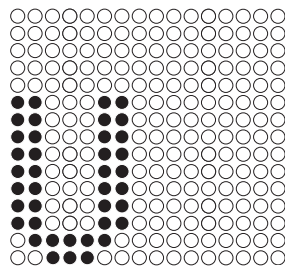

CHR117

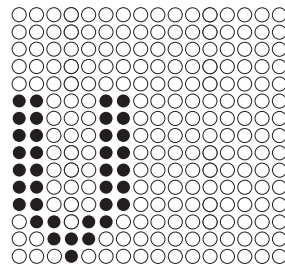

CHR118

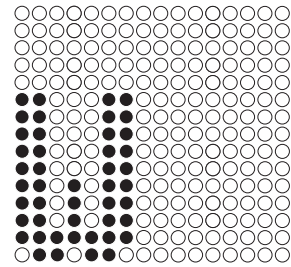

CHR119

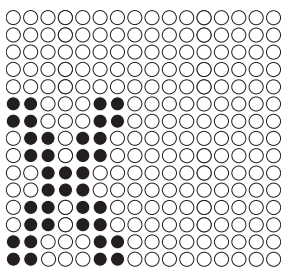

CHR120

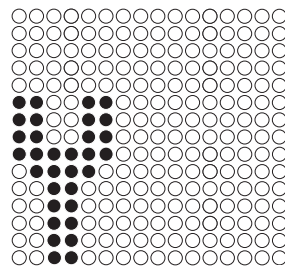

CHR121

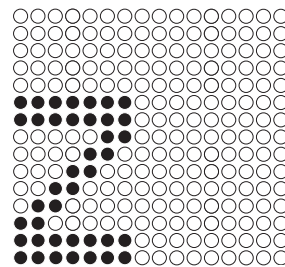

CHR122

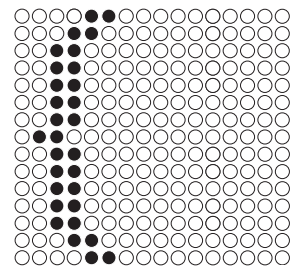

CHR123

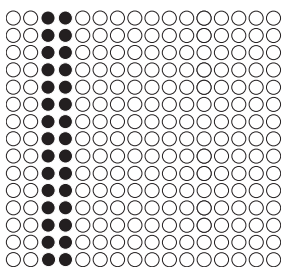

CHR124

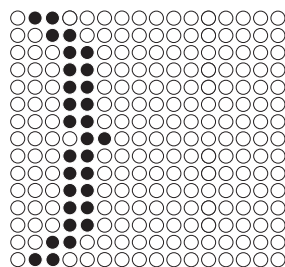

CHR125

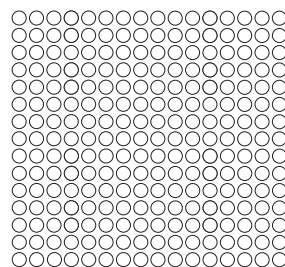

CHR126

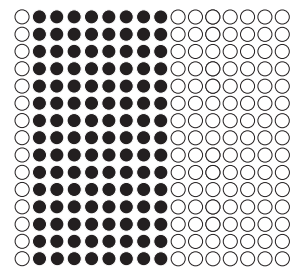

CHR127

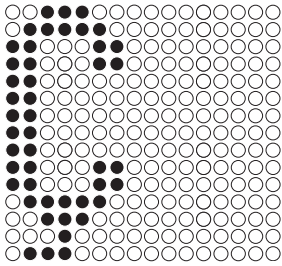

CHR128

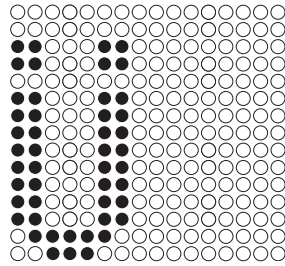

CHR129

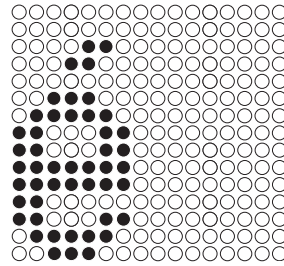

CHR130

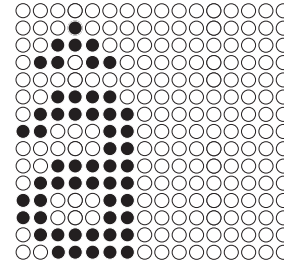

CHR131

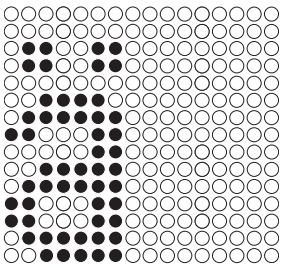

CHR132

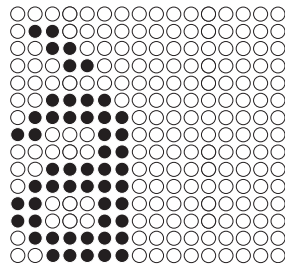

CHR133

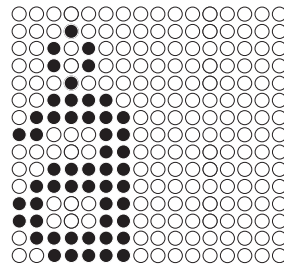

CHR134

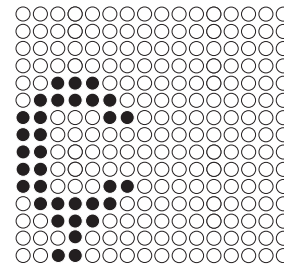

CHR135

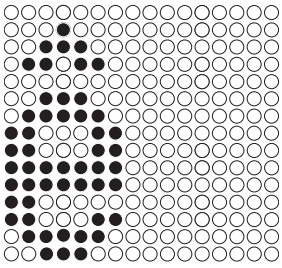

CHR136

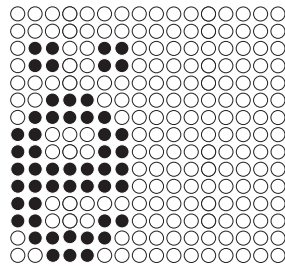

CHR137

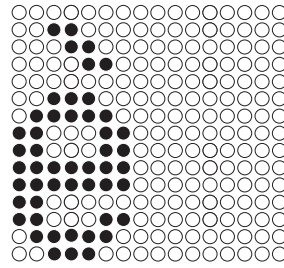

CHR138

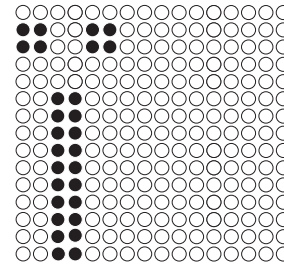

CHR139

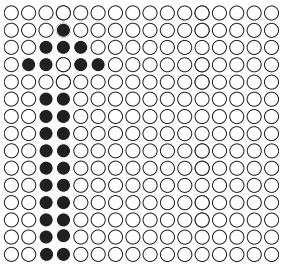

CHR140

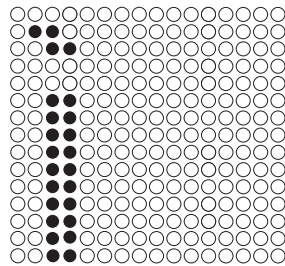

CHR141

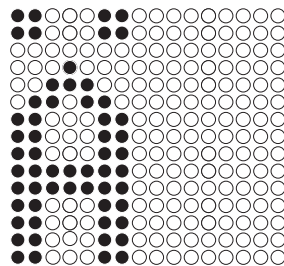

CHR142

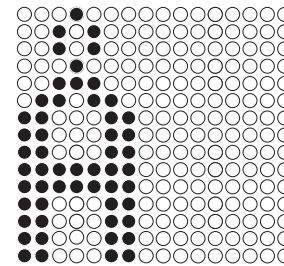

CHR143

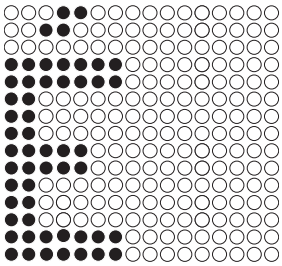

CHR144

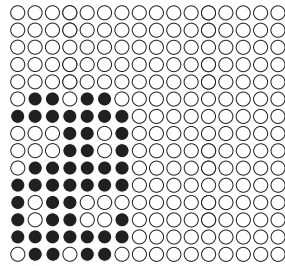

CHR145

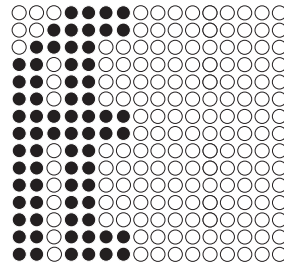

CHR146

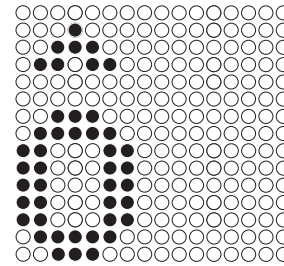

CHR147

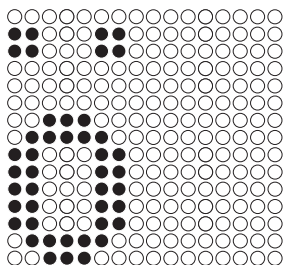

CHR148

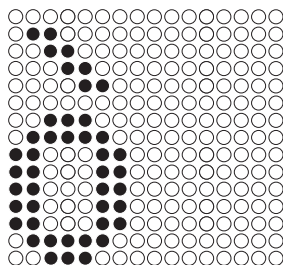

CHR149

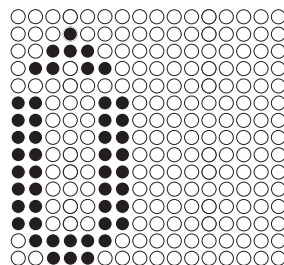

CHR150

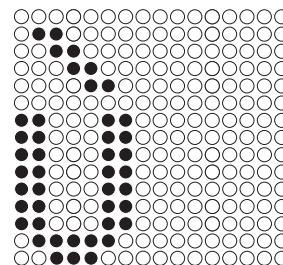

CHR151

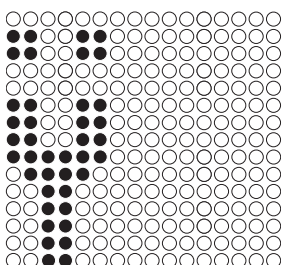

CHR152

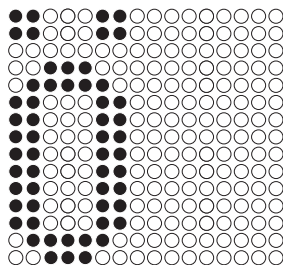

CHR153

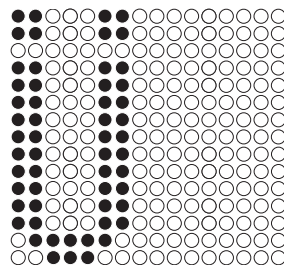

CHR154

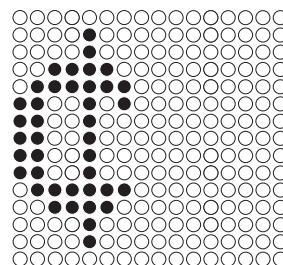

CHR155

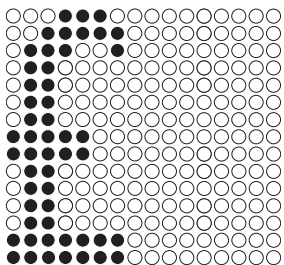

CHR156

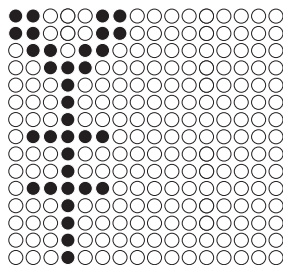

CHR157

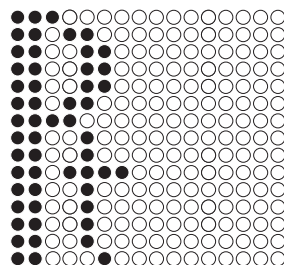

CHR158

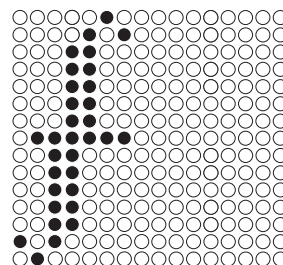

CHR159

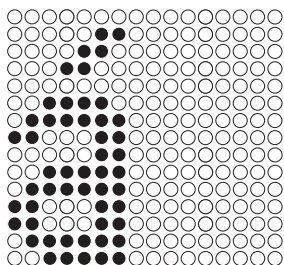

CHR160

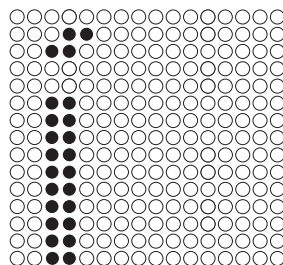

CHR161

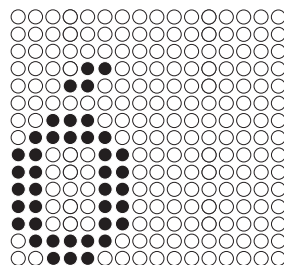

CHR162

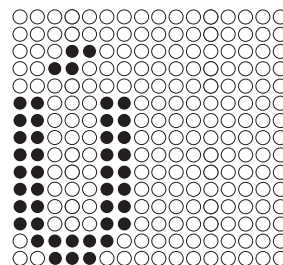

CHR163

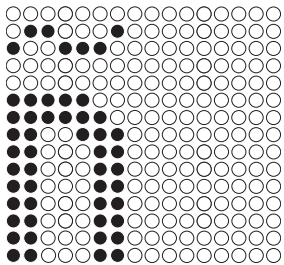

CHR164

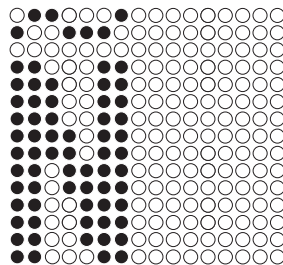

CHR165

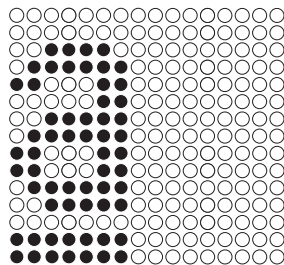

CHR166

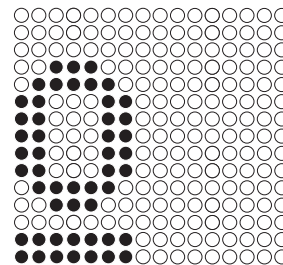

CHR167

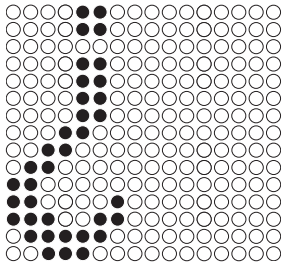

CHR168

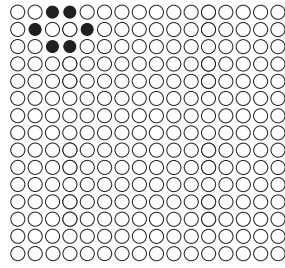

CHR169

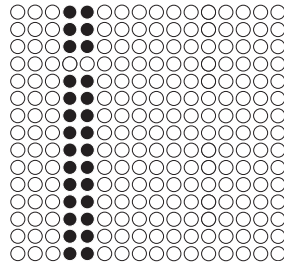

CHR170

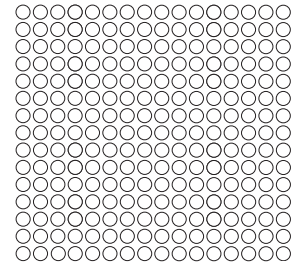

CHR171

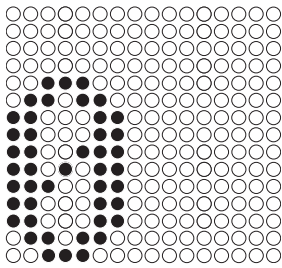

CHR172

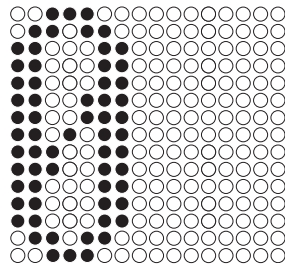

CHR173

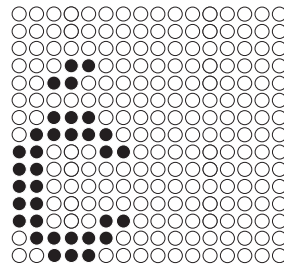

CHR174

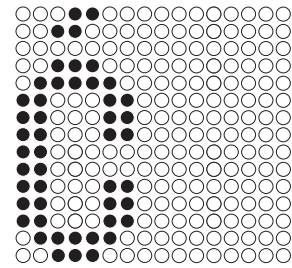

CHR175

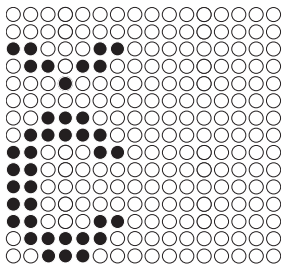

CHR176

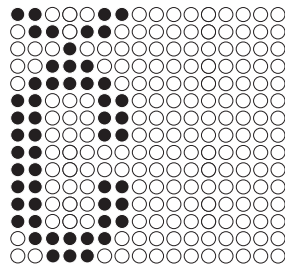

CHR177

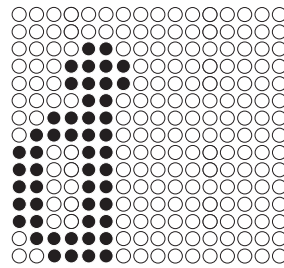

CHR178

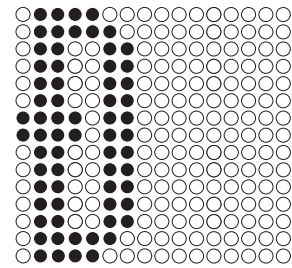

CHR179

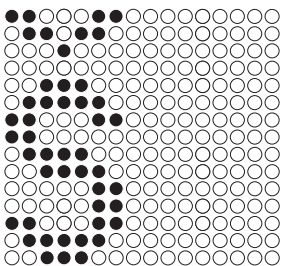

CHR180

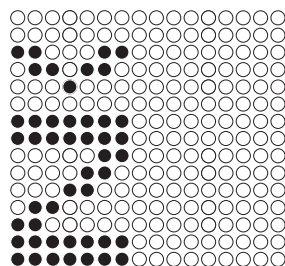

CHR181

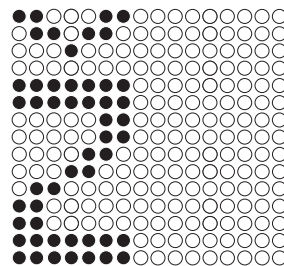

CHR182

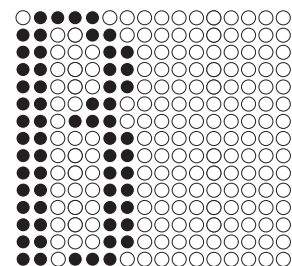

CHR183

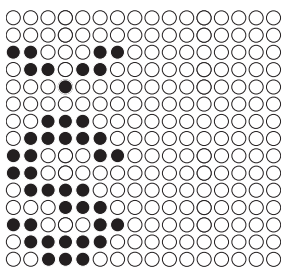

CHR184

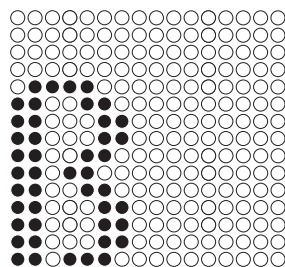

CHR185

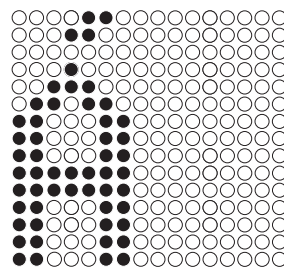

CHR186

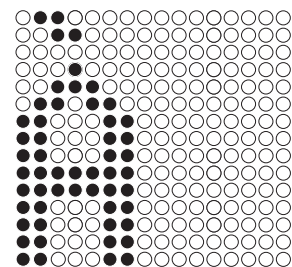

CHR187

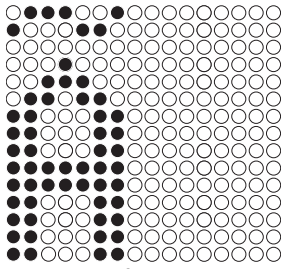

CHR188

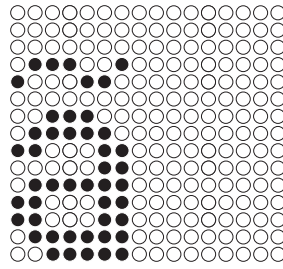

CHR189

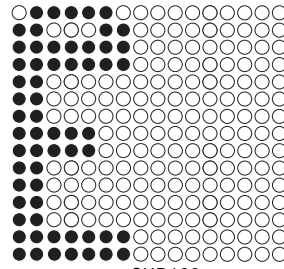

CHR190

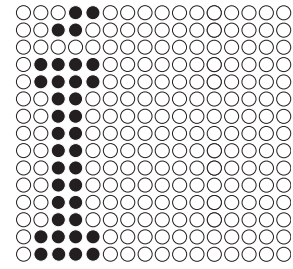

CHR191

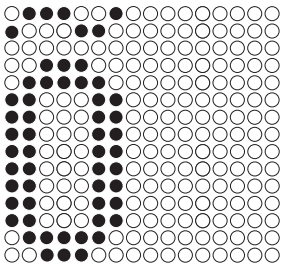

CHR192

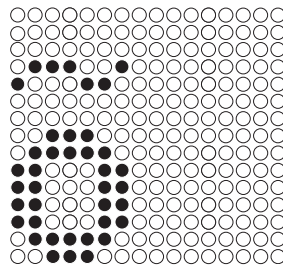

CHR193

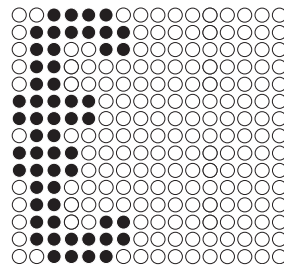

CHR194

**7.15.12 15-High Fancy (SF15)**

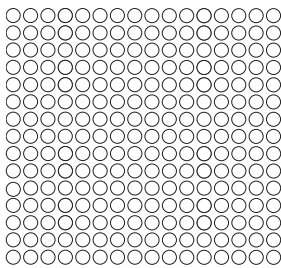

CHR032

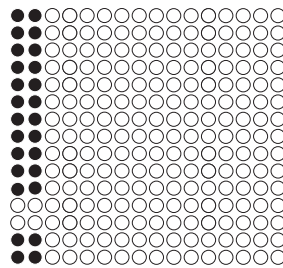

CHR033

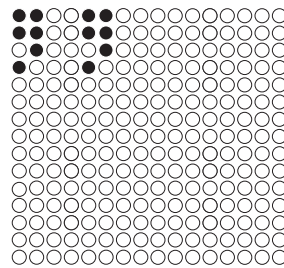

CHR034

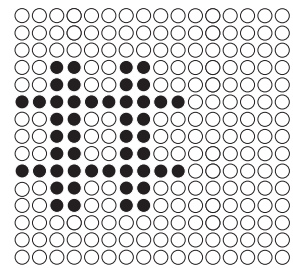

CHR035

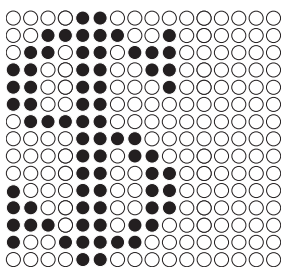

CHR036

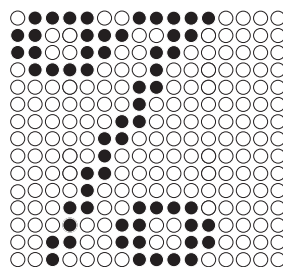

CHR037

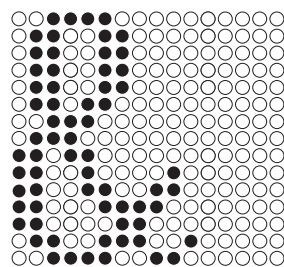

CHR038

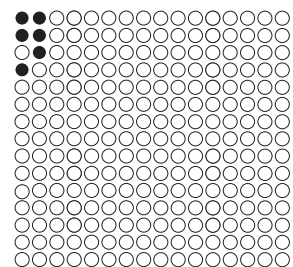

CHR039

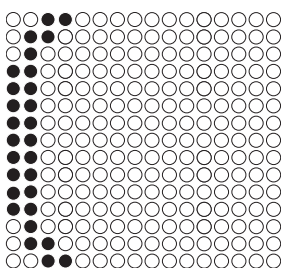

CHR040

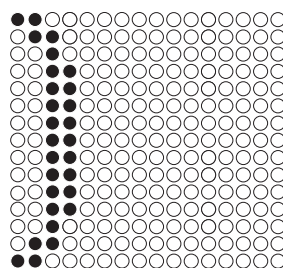

CHR041

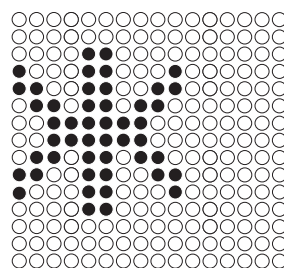

CHR042

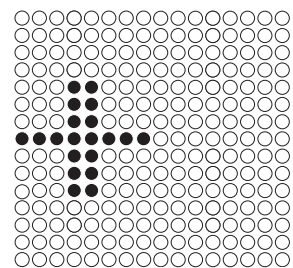

CHR043

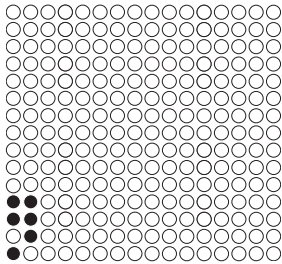

CHR044

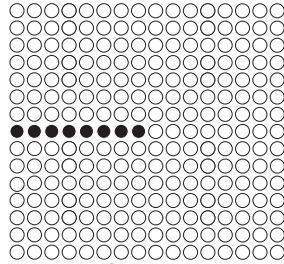

CHR045

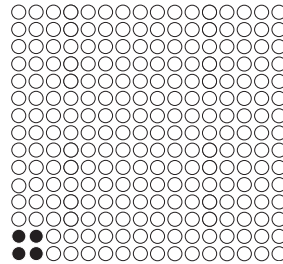

CHR046

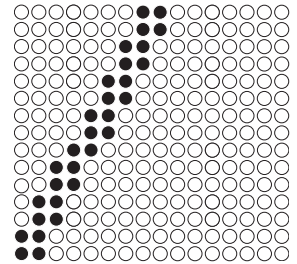

CHR047

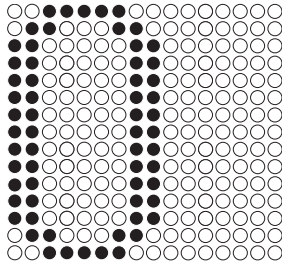

CHR048

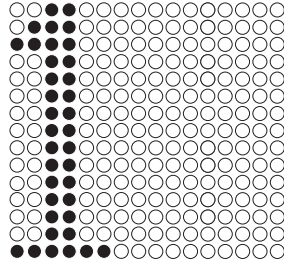

CHR049

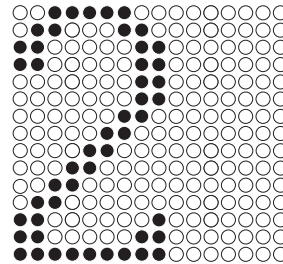

CHR050

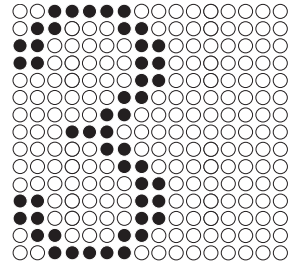

CHR051

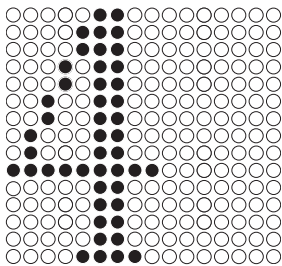

CHR052

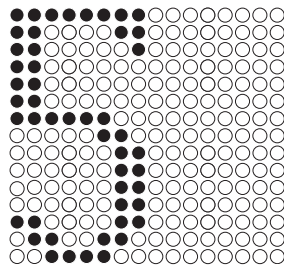

CHR053

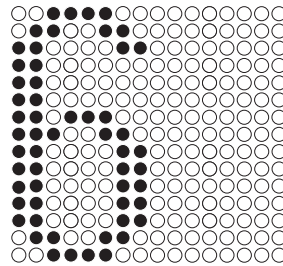

CHR054

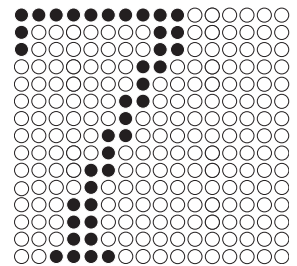

CHR055

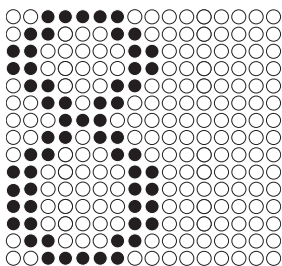

CHR056

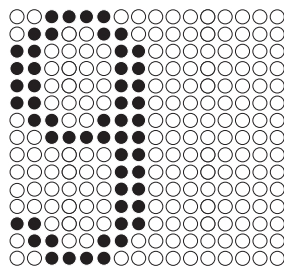

CHR057

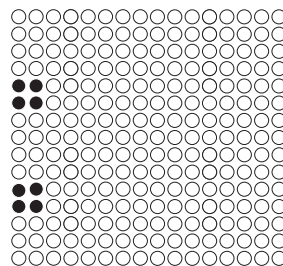

CHR058

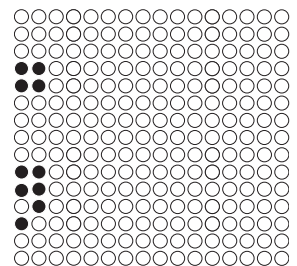

CHR059

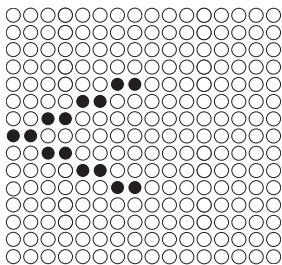

CHR060

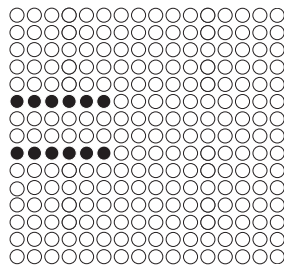

CHR061

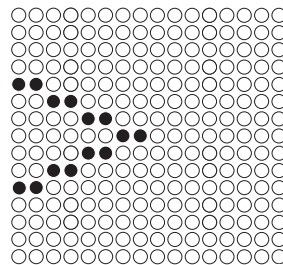

CHR062

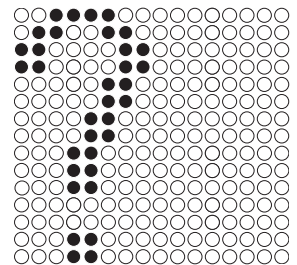

CHR063









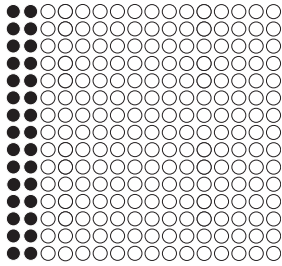

CHR124

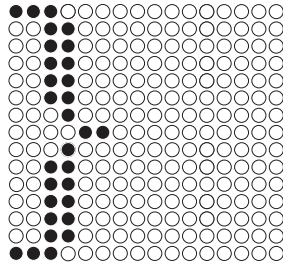

CHR125

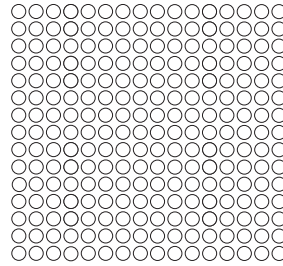

CHR126

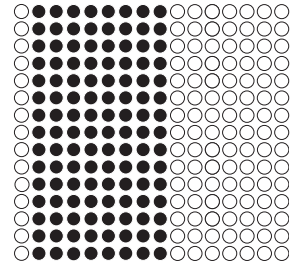

CHR127

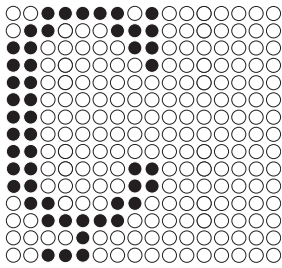

CHR128

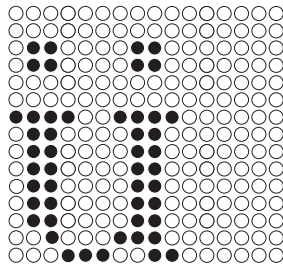

CHR129

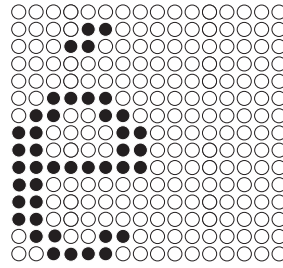

CHR130

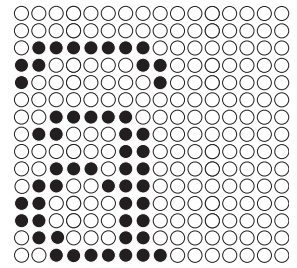

CHR131

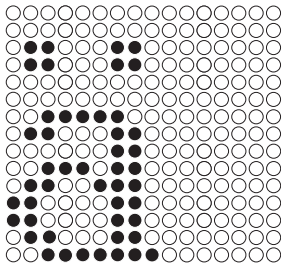

CHR132

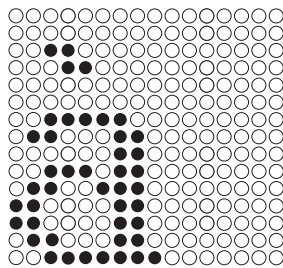

CHR133

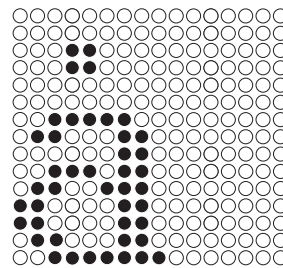

CHR134

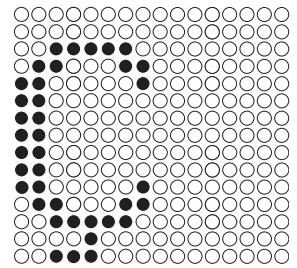

CHR135

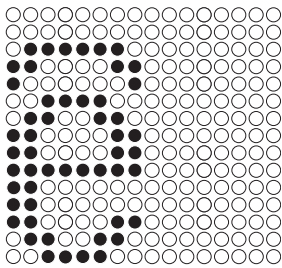

CHR136

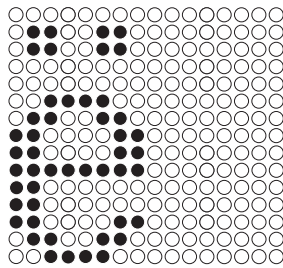

CHR137

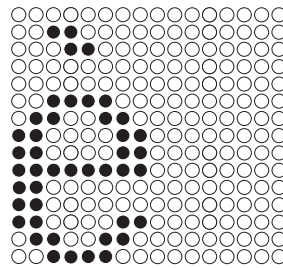

CHR138

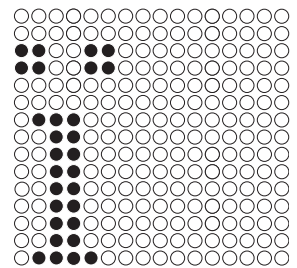

CHR139

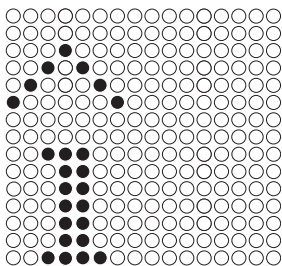

CHR140

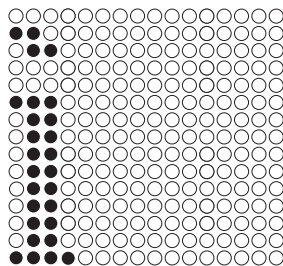

CHR141

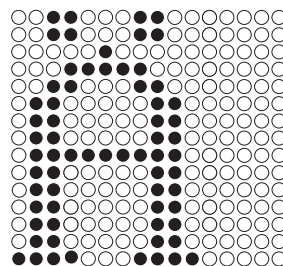

CHR142

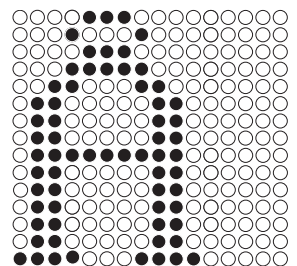

CHR143

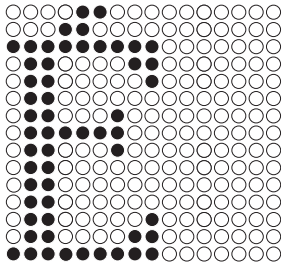

CHR144

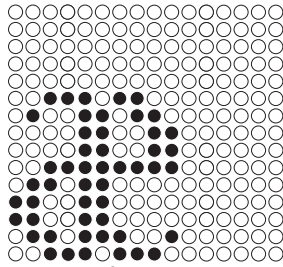

CHR145

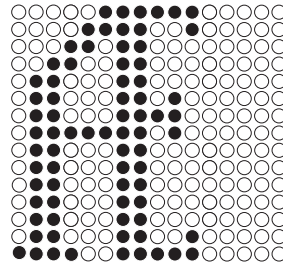

CHR146

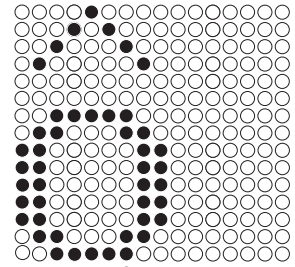

CHR147

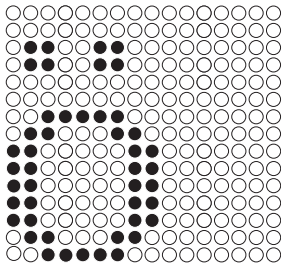

CHR148

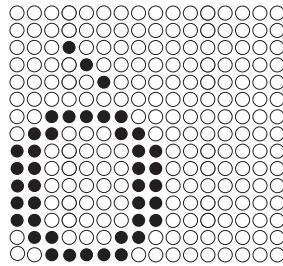

CHR149

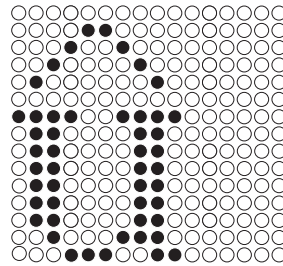

CHR150

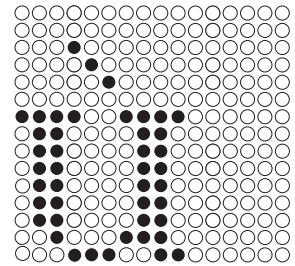

CHR151

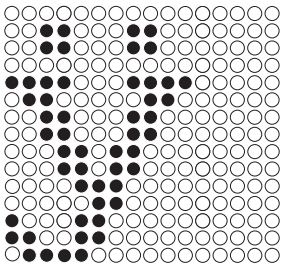

CHR152

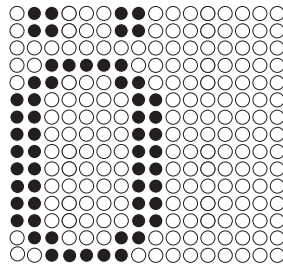

CHR153

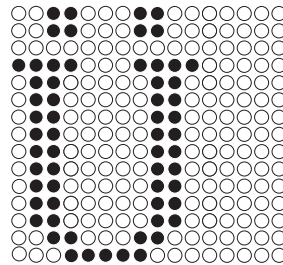

CHR154

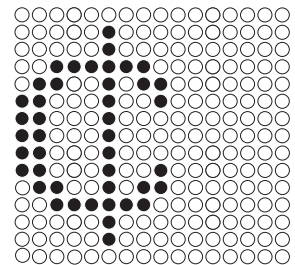

CHR155

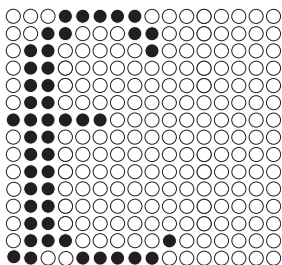

CHR156

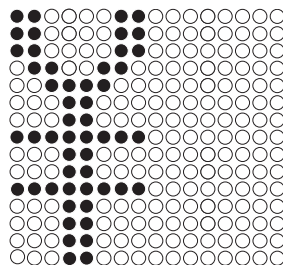

CHR157

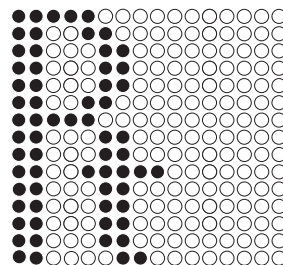

CHR158

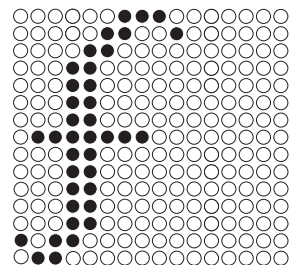

CHR159

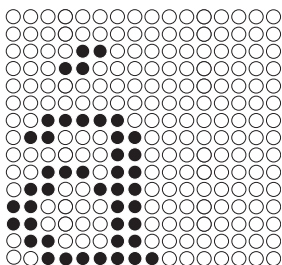

CHR160

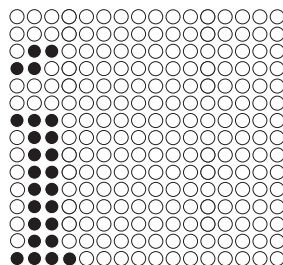

CHR161

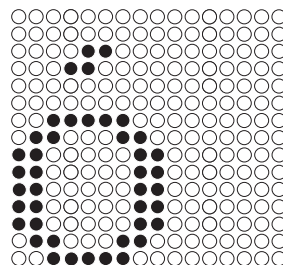

CHR162

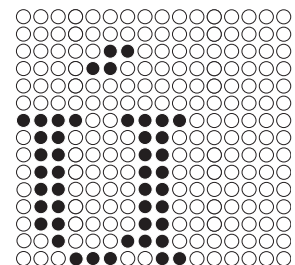

CHR163



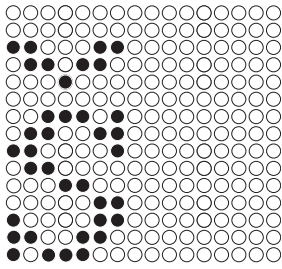

CHR184

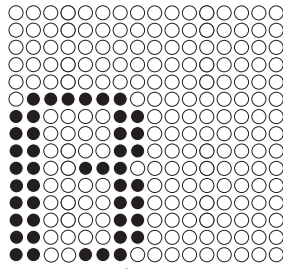

CHR185

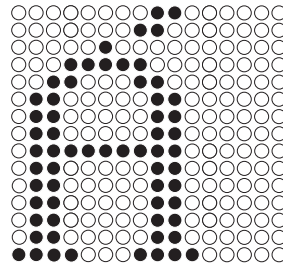

CHR186

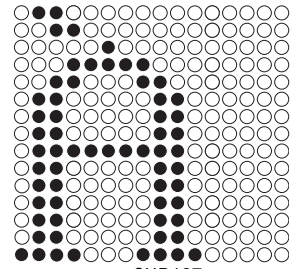

CHR187

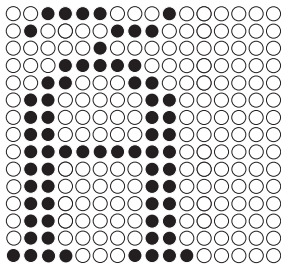

CHR188

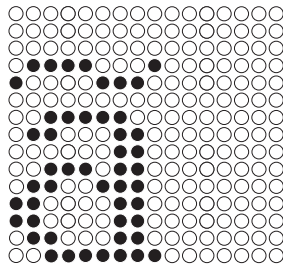

CHR189

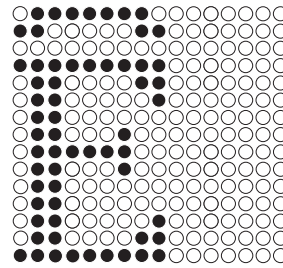

CHR190

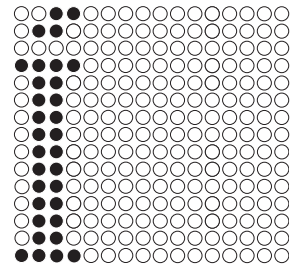

CHR191

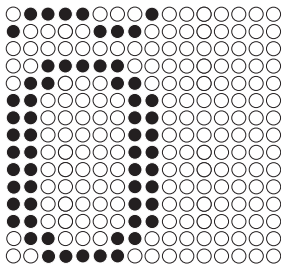

CHR192

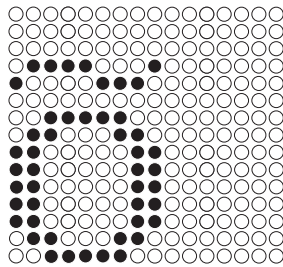

CHR193

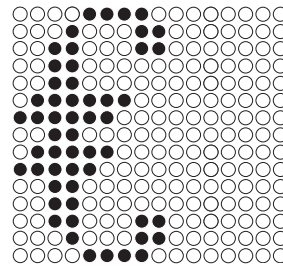

CHR194

**7.15.13 15-High True Descender Regular**

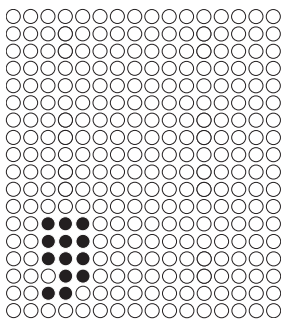

CHR15C

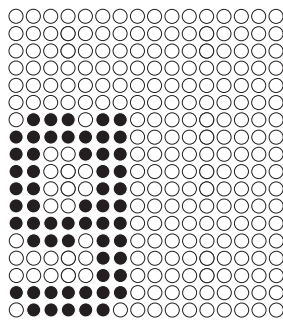

CHR15G

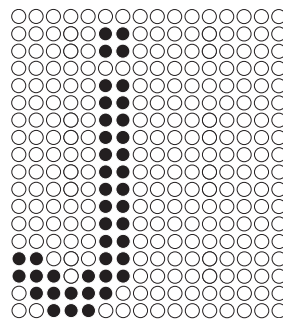

CHR15J

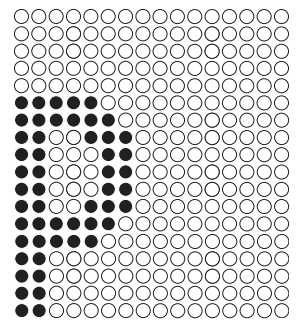

CHR15P

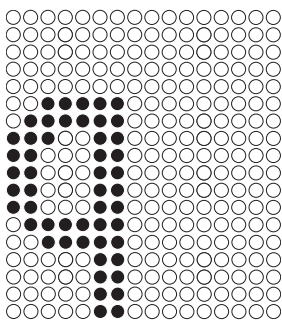

CHR15Q

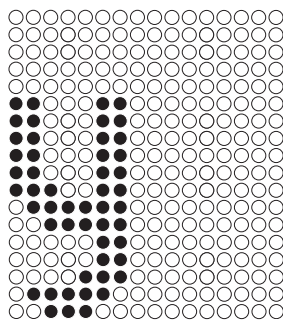

CHR15Y

### 7.15.14 15-High True Descender Fancy

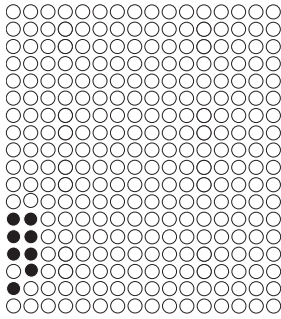

CR15FC

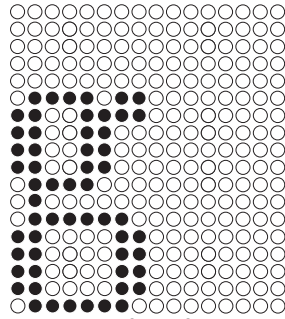

CR15FG

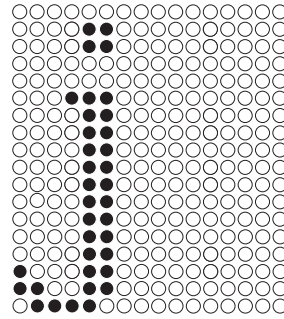

CR15FJ

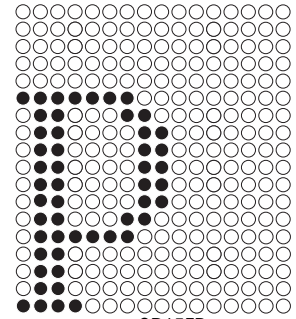

CR15FP

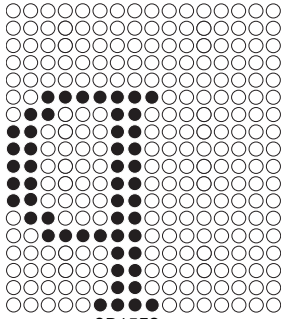

CR15FQ

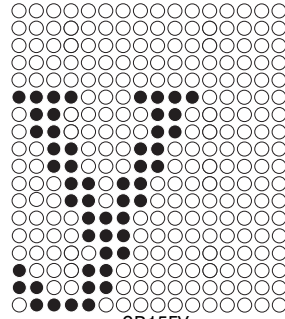

CR15FY

### 7.15.15 15-High Fat Character

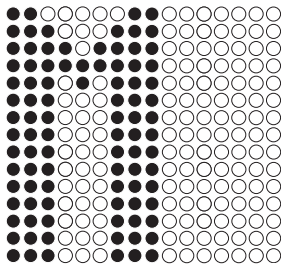

FATM

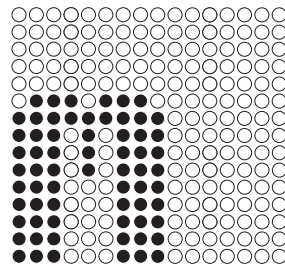

FATM1

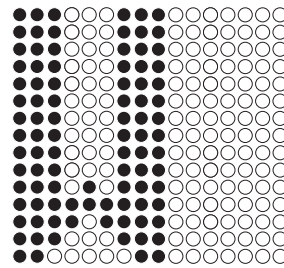

FATW

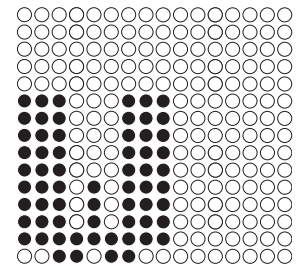

FATW1

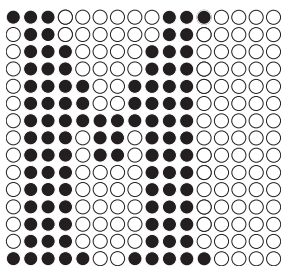

FFATM

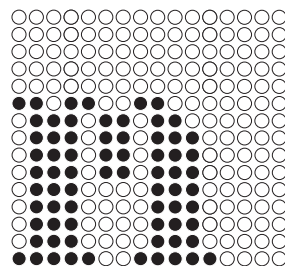

FFATM1

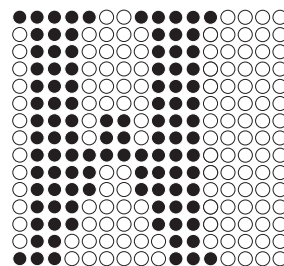

FFATW

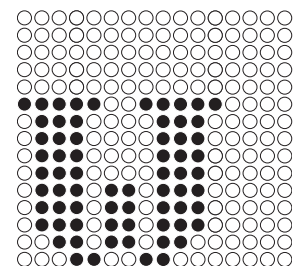

FFATW1

7.15.16 16-High Regular (SS16)

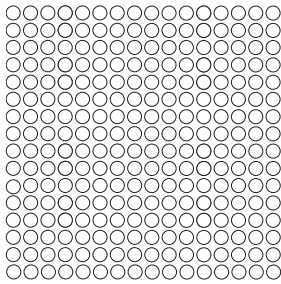

CHR032

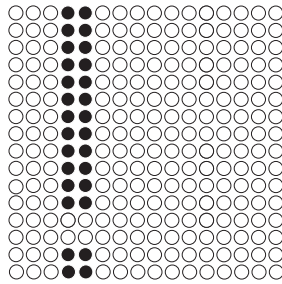

CHR033

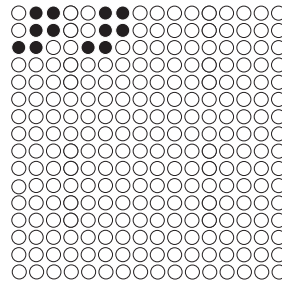

CHR034

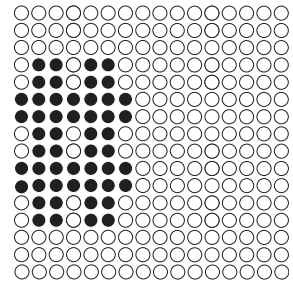

CHR035

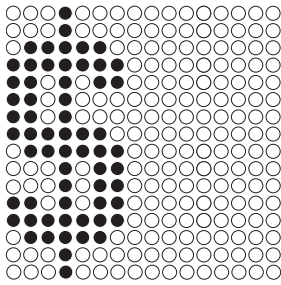

CHR036

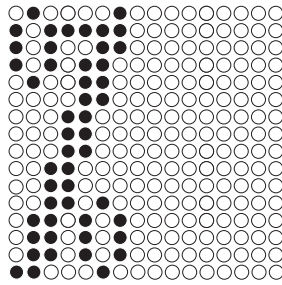

CHR037

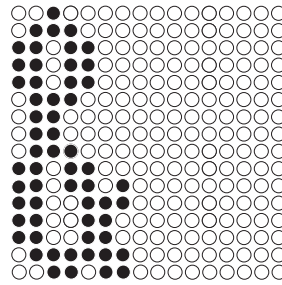

CHR038

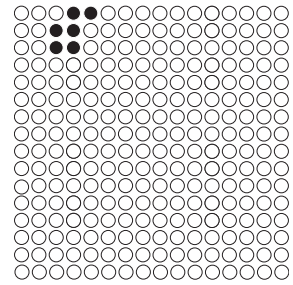

CHR039

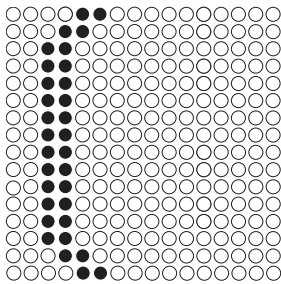

CHR040

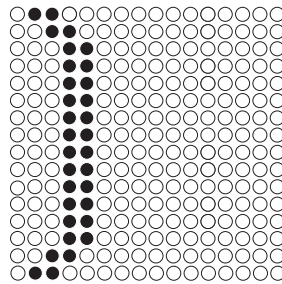

CHR041

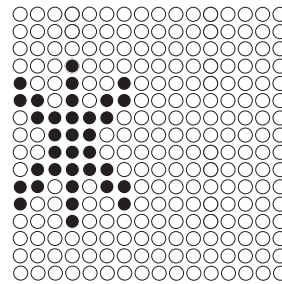

CHR042

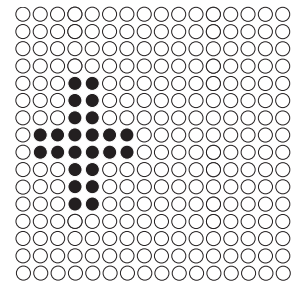

CHR043

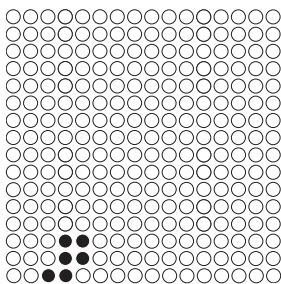

CHR044

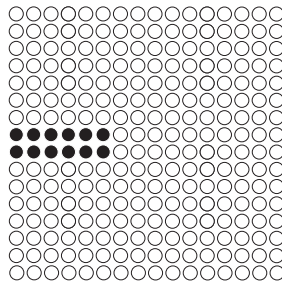

CHR045

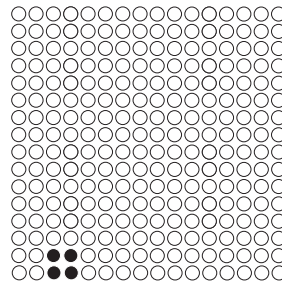

CHR046

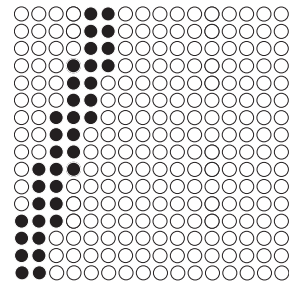

CHR047

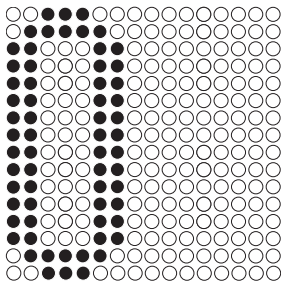

CHR048

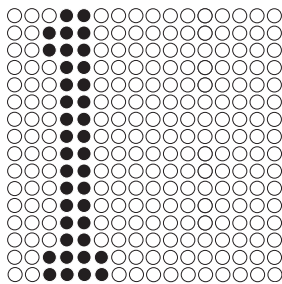

CHR049

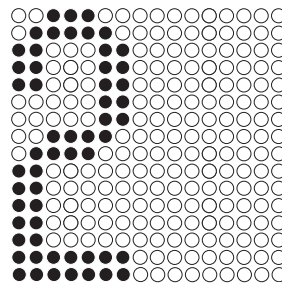

CHR050

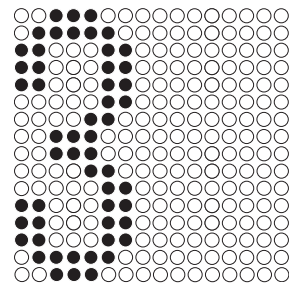

CHR051





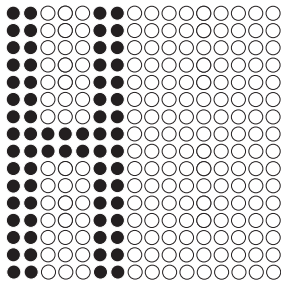

CHR072

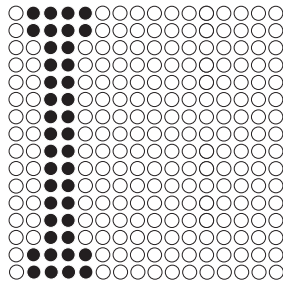

CHR073

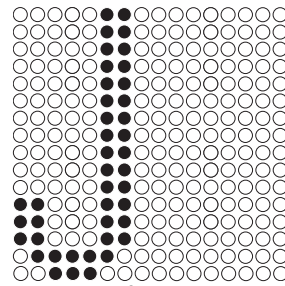

CHR074

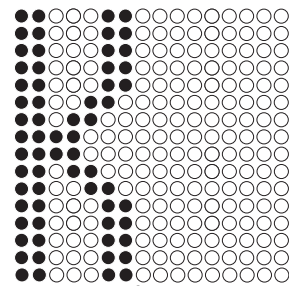

CHR075

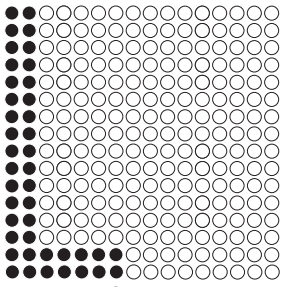

CHR076

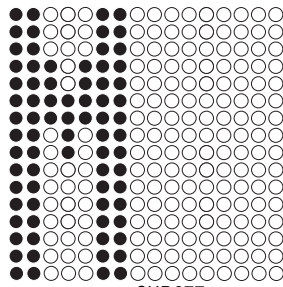

CHR077

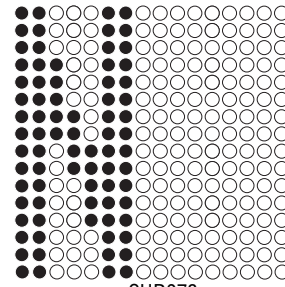

CHR078

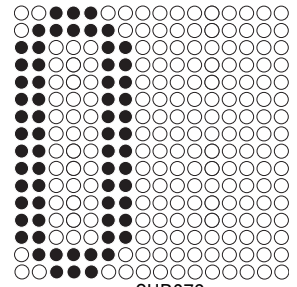

CHR079

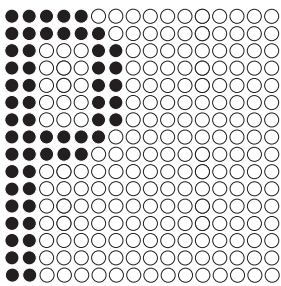

CHR080

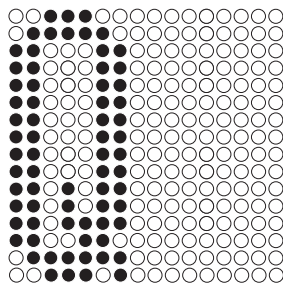

CHR081

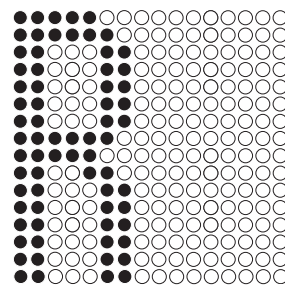

CHR082

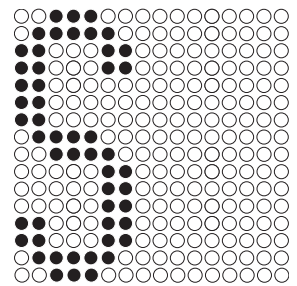

CHR083

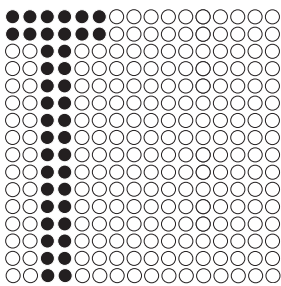

CHR084

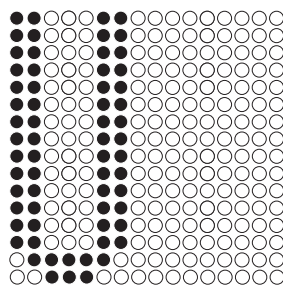

CHR085

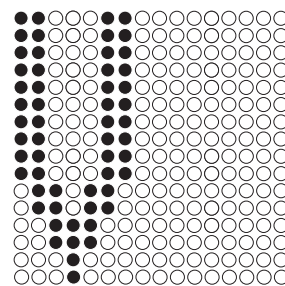

CHR086

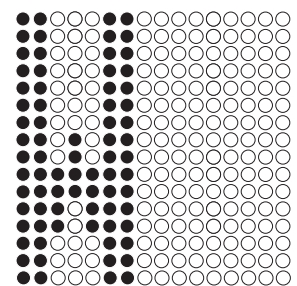

CHR087

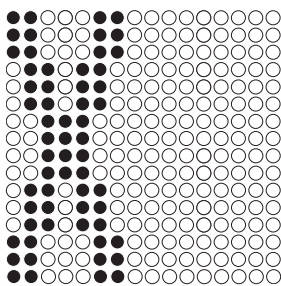

CHR088

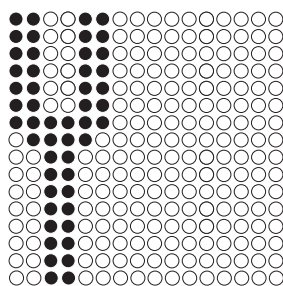

CHR089

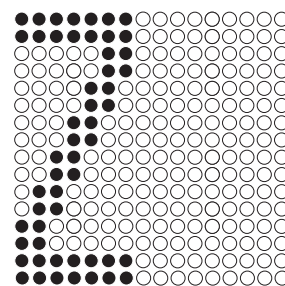

CHR090

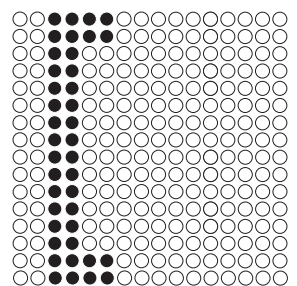

CHR091

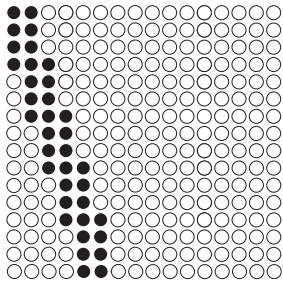

CHR092

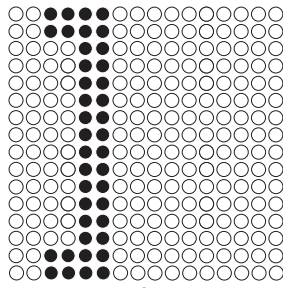

CHR093

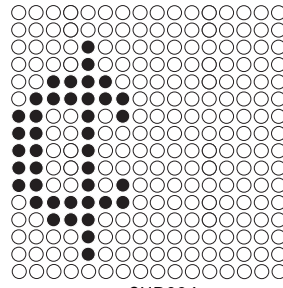

CHR094

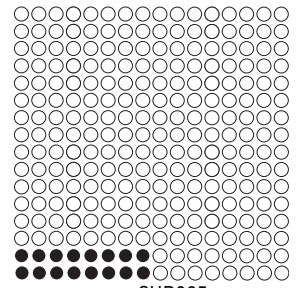

CHR095

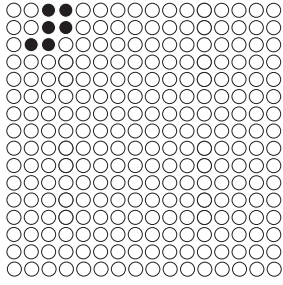

CHR096

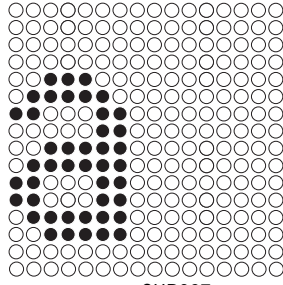

CHR097

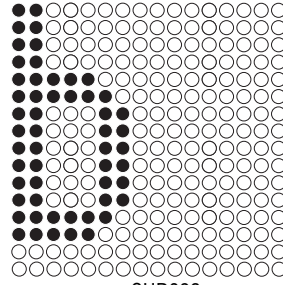

CHR098

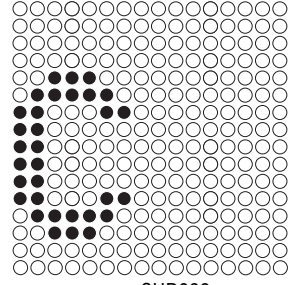

CHR099

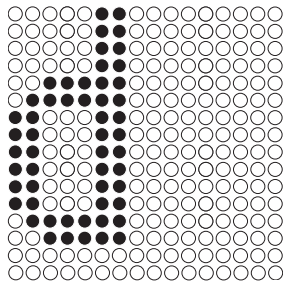

CHR100

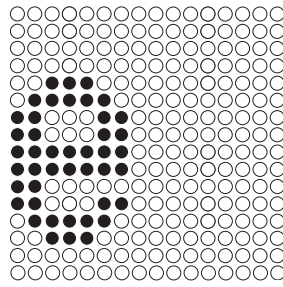

CHR101

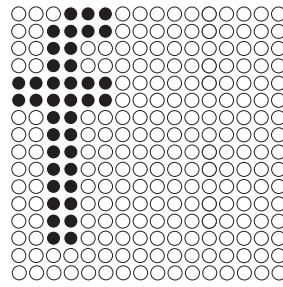

CHR102

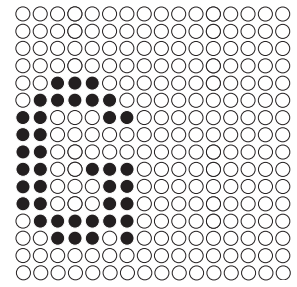

CHR103

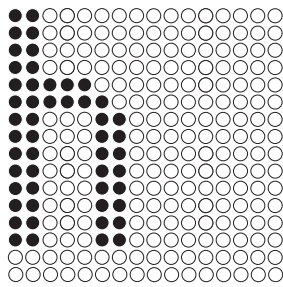

CHR104

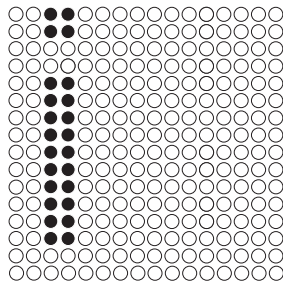

CHR105

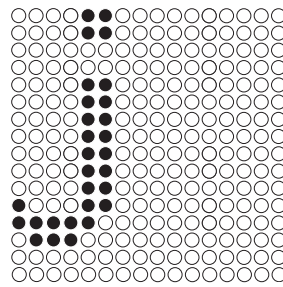

CHR106

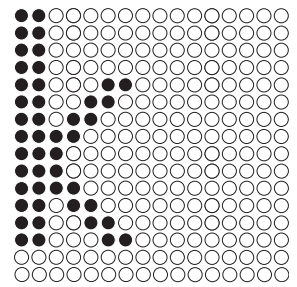

CHR107

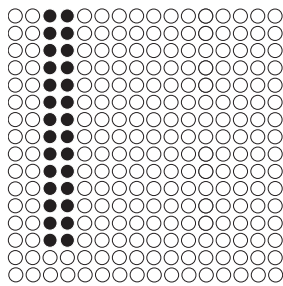

CHR108

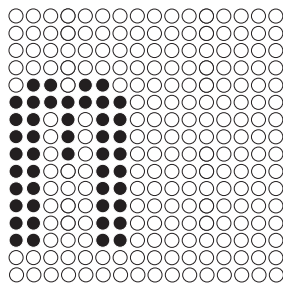

CHR109

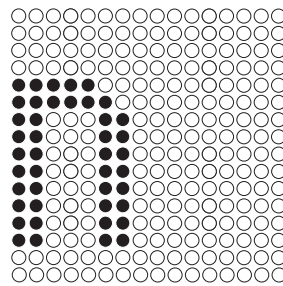

CHR110

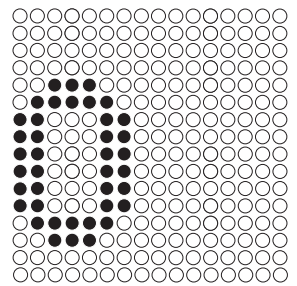

CHR111

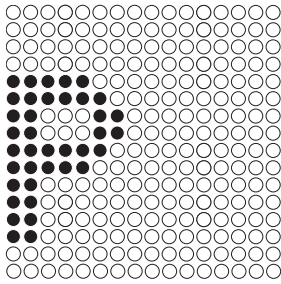

CHR112

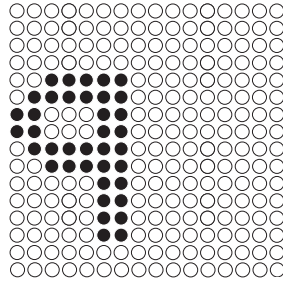

CHR113

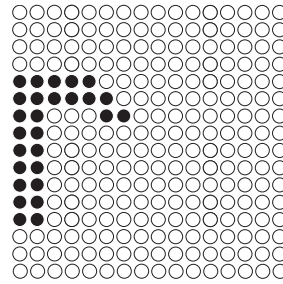

CHR114

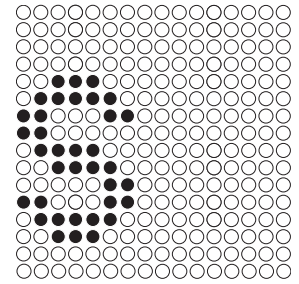

CHR115

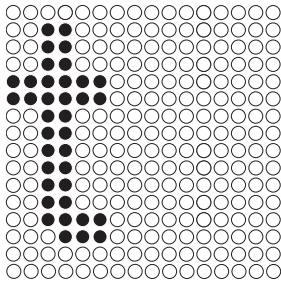

CHR116

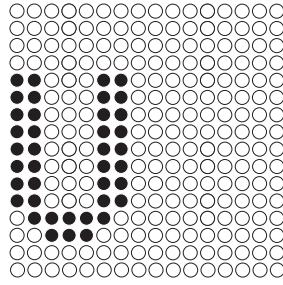

CHR117

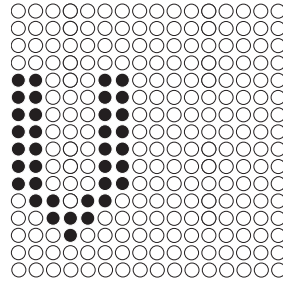

CHR118

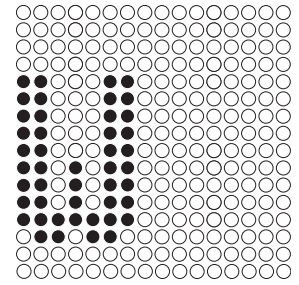

CHR119

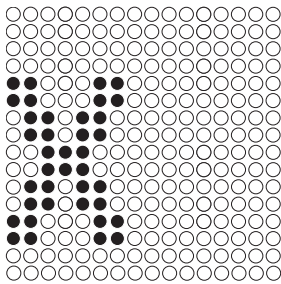

CHR120

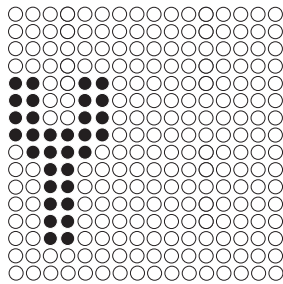

CHR121

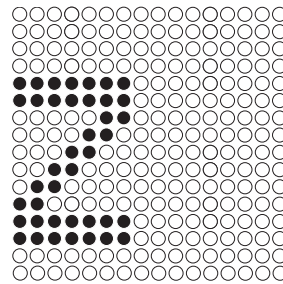

CHR122

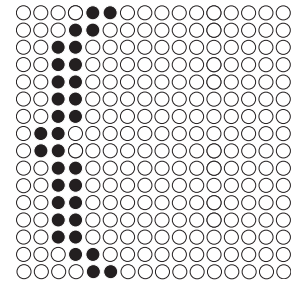

CHR123

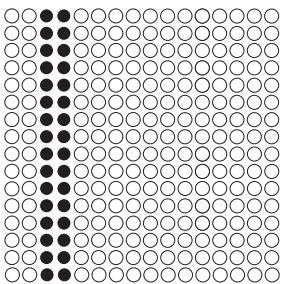

CHR124

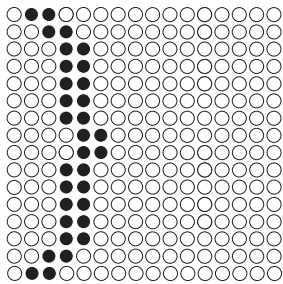

CHR125

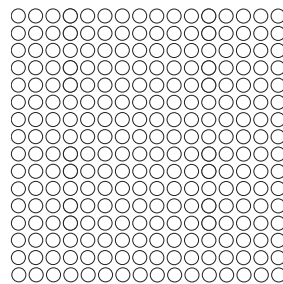

CHR126

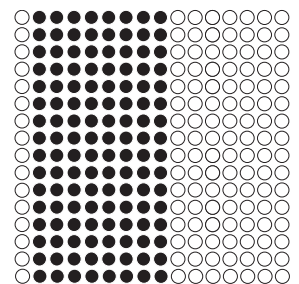

CHR127

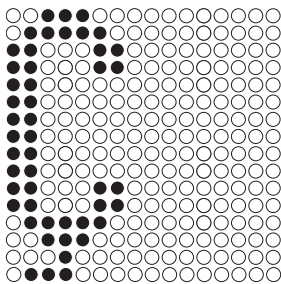

CHR128

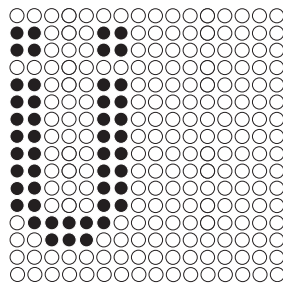

CHR129

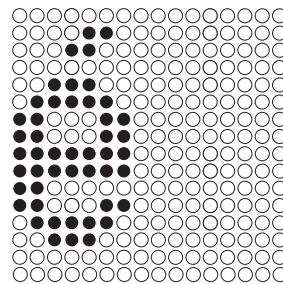

CHR130

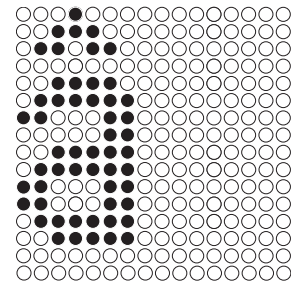

CHR131

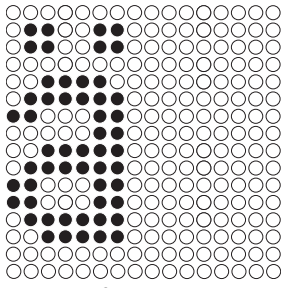

CHR132

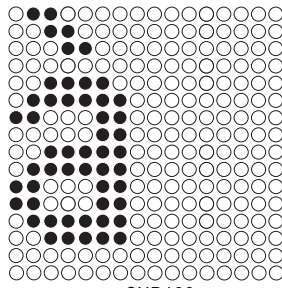

CHR133

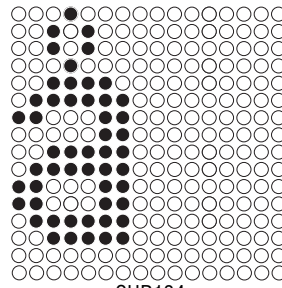

CHR134

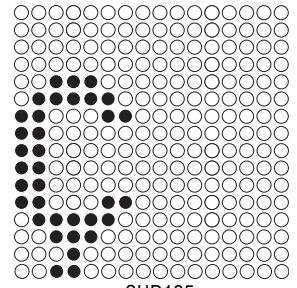

CHR135

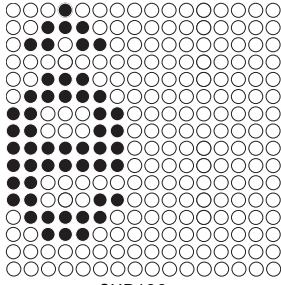

CHR136

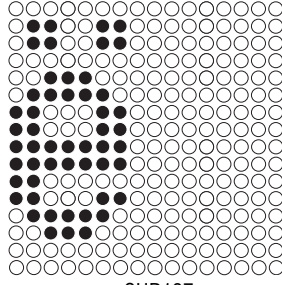

CHR137

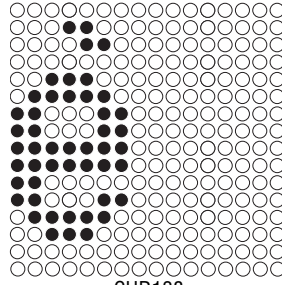

CHR138

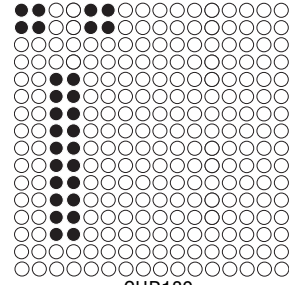

CHR139

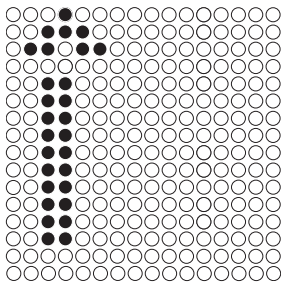

CHR140

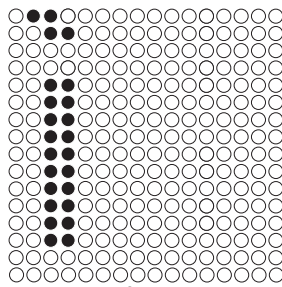

CHR141

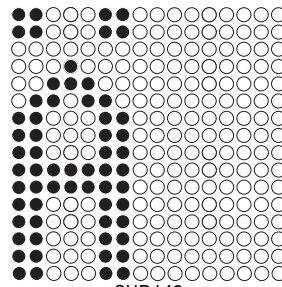

CHR142

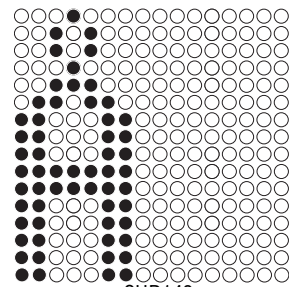

CHR143

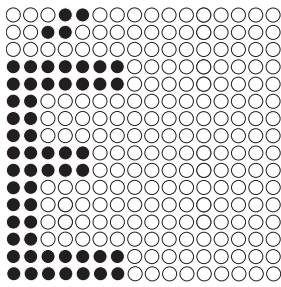

CHR144

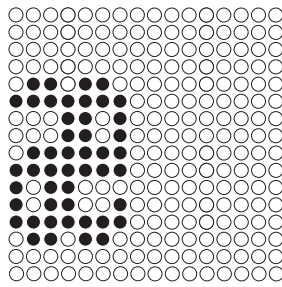

CHR145

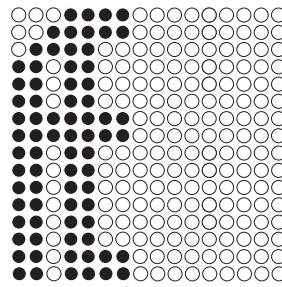

CHR146

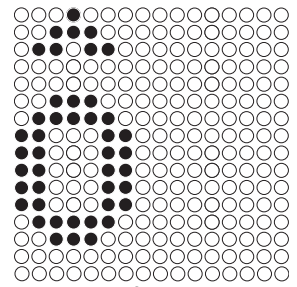

CHR147

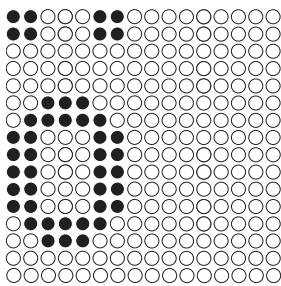

CHR148

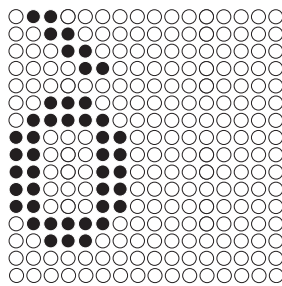

CHR149

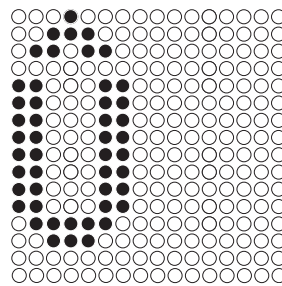

CHR150

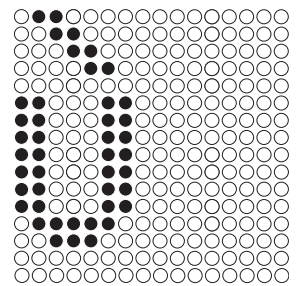

CHR151



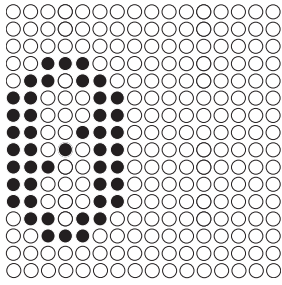

CHR172

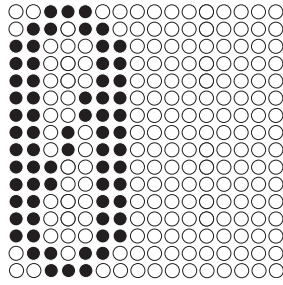

CHR173

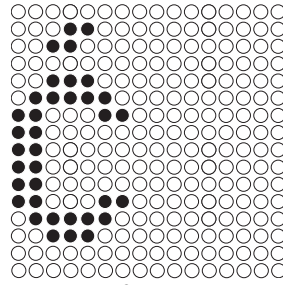

CHR174

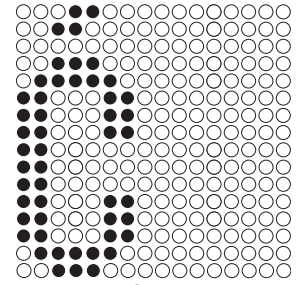

CHR175

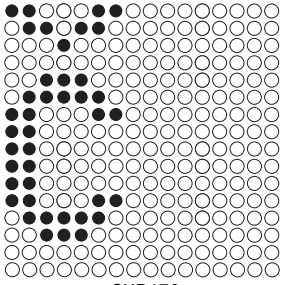

CHR176

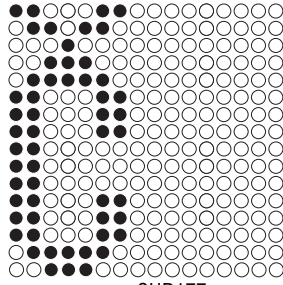

CHR177

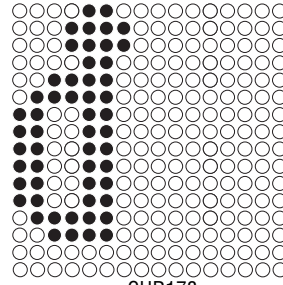

CHR178

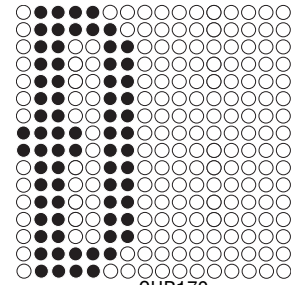

CHR179

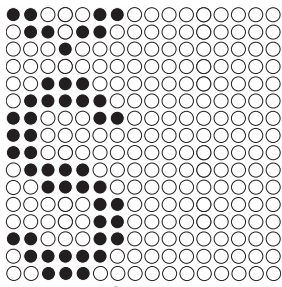

CHR180

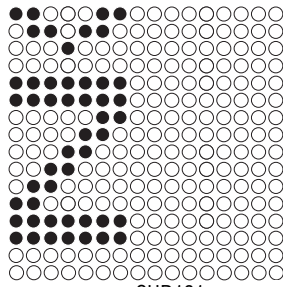

CHR181

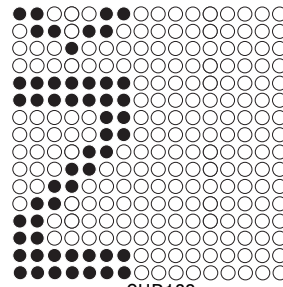

CHR182

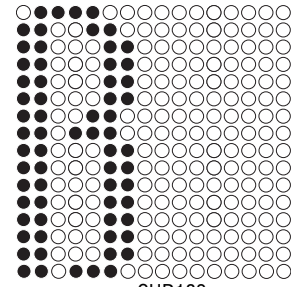

CHR183

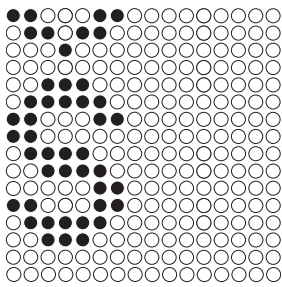

CHR184

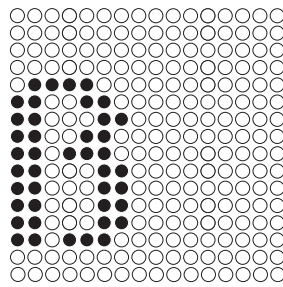

CHR185

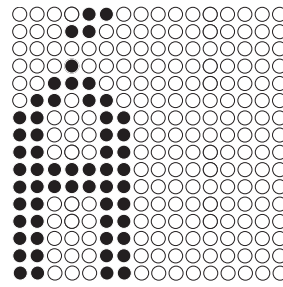

CHR186

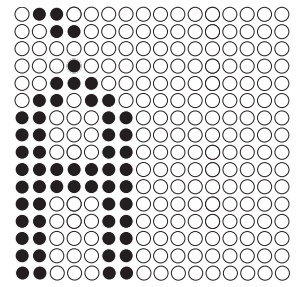

CHR187

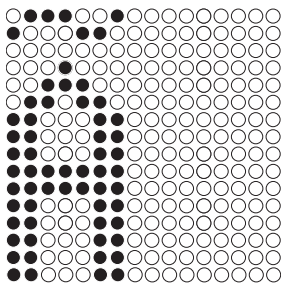

CHR188

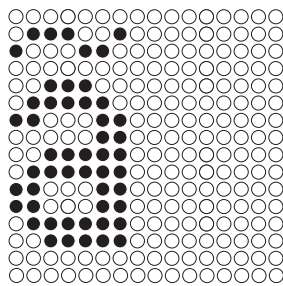

CHR189

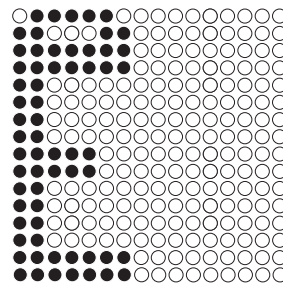

CHR190

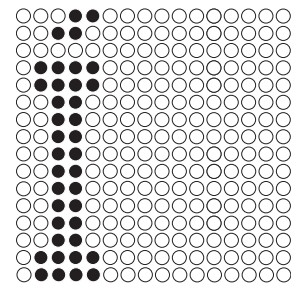

CHR191





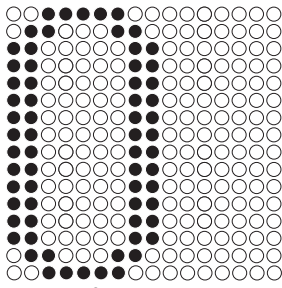

CHR048

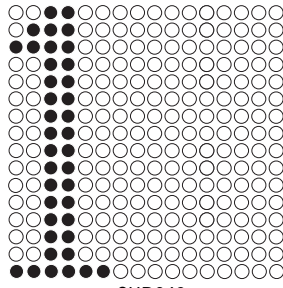

CHR049

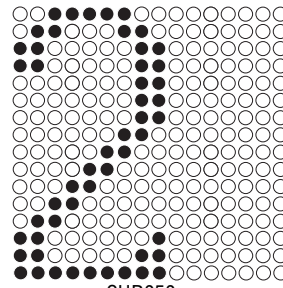

CHR050

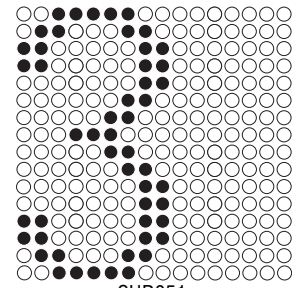

CHR051

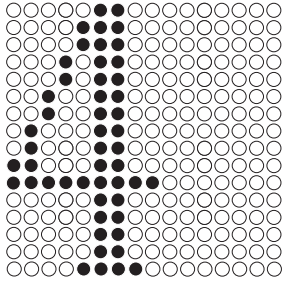

CHR052

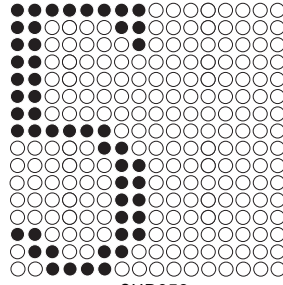

CHR053

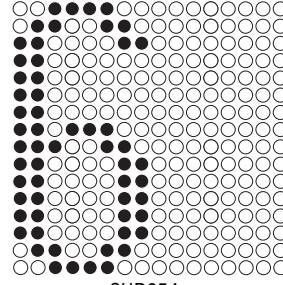

CHR054

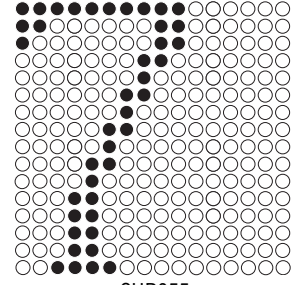

CHR055

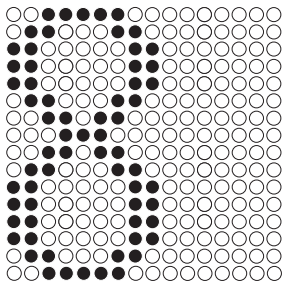

CHR056

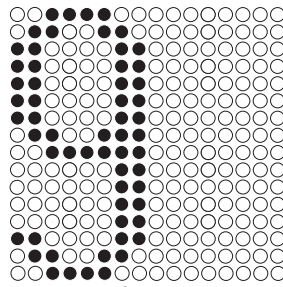

CHR057

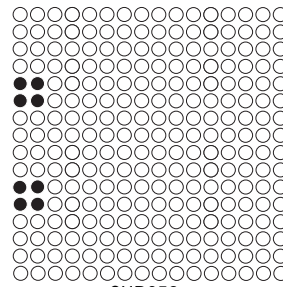

CHR058

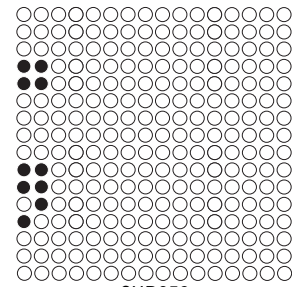

CHR059

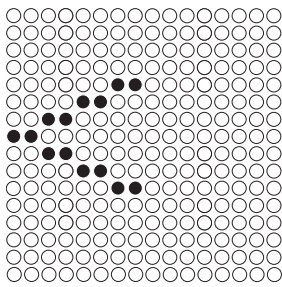

CHR060

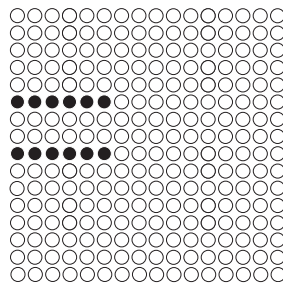

CHR061

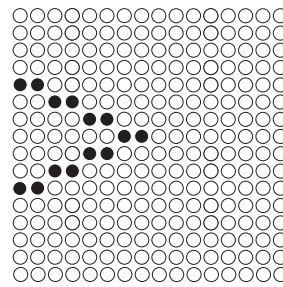

CHR062

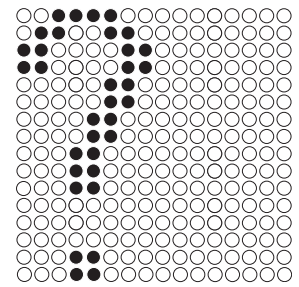

CHR063

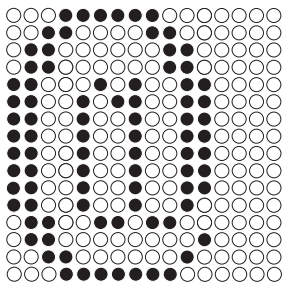

CHR064

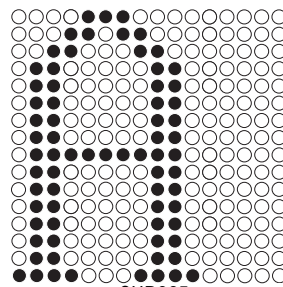

CHR065

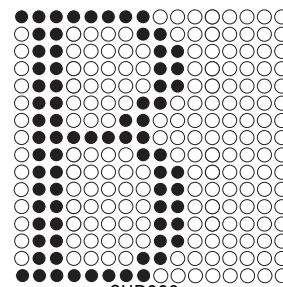

CHR066

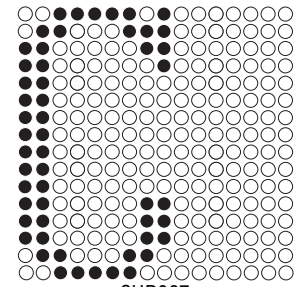

CHR067



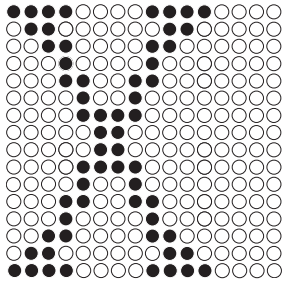

CHR088

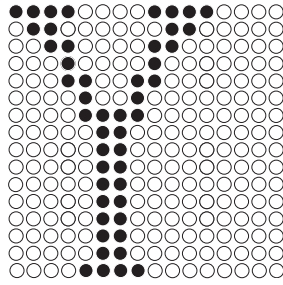

CHR089

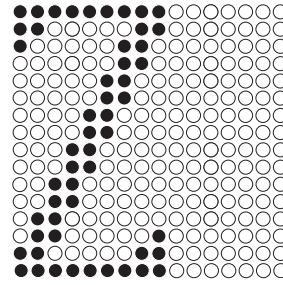

CHR090

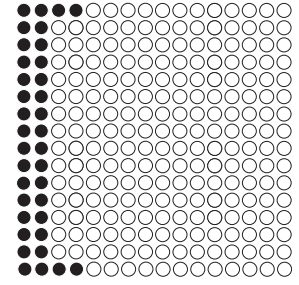

CHR091

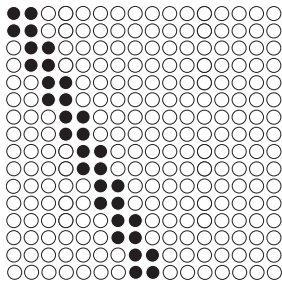

CHR092

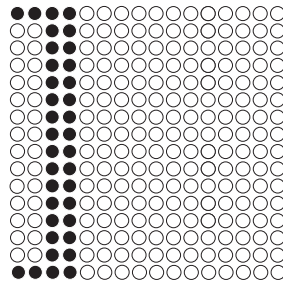

CHR093

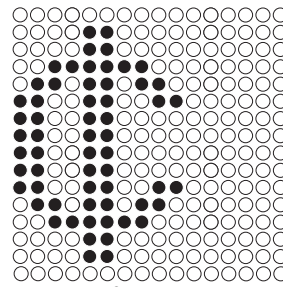

CHR094

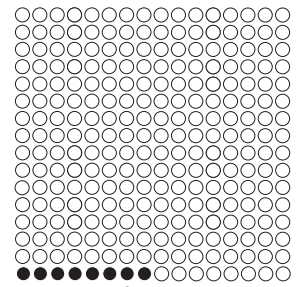

CHR095

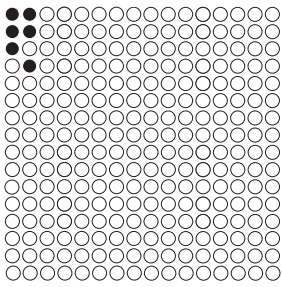

CHR096

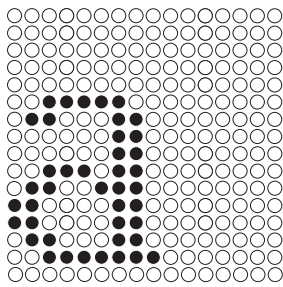

CHR097

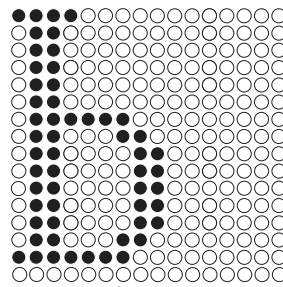

CHR098

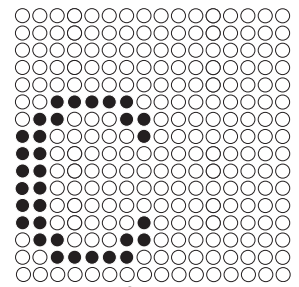

CHR099

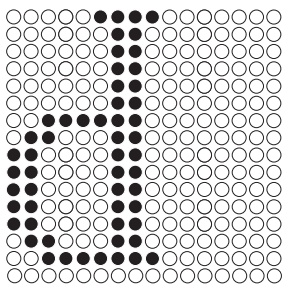

CHR100

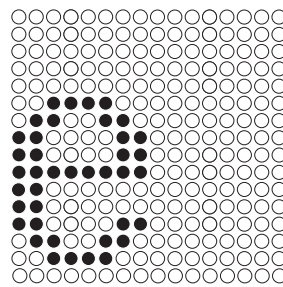

CHR101

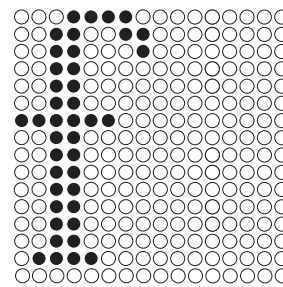

CHR102

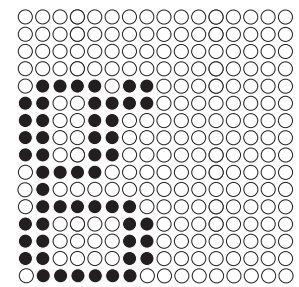

CHR103

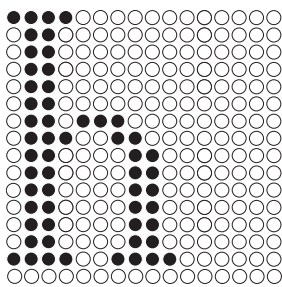

CHR104

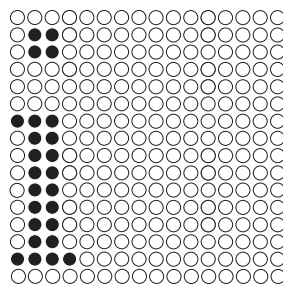

CHR105

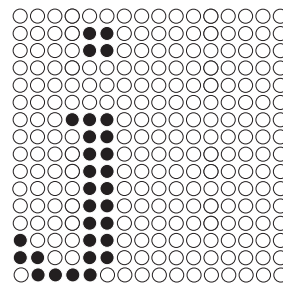

CHR106

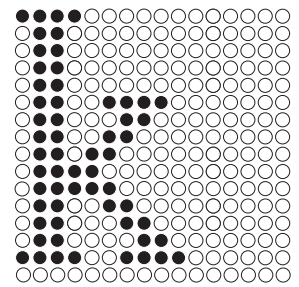

CHR107



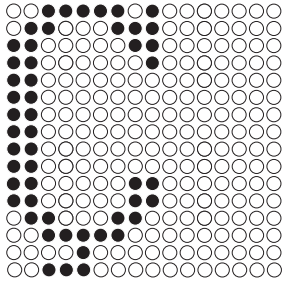

CHR128

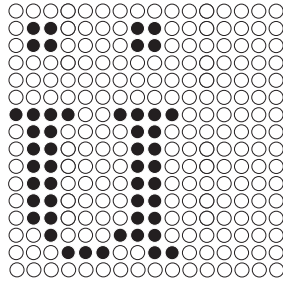

CHR129

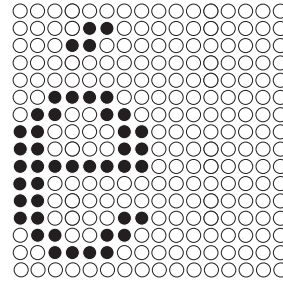

CHR130

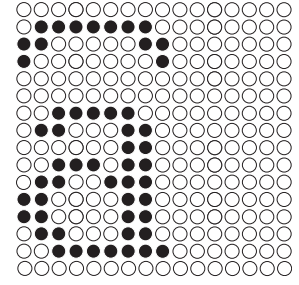

CHR131

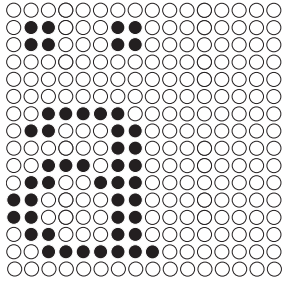

CHR132

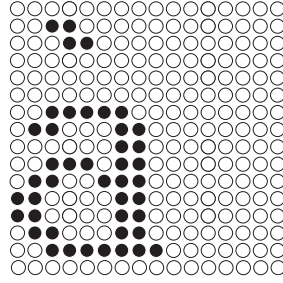

CHR133

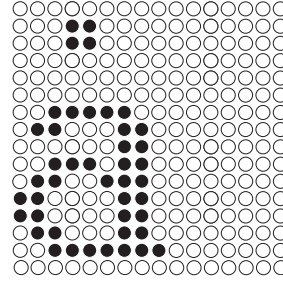

CHR134

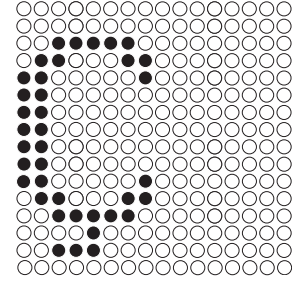

CHR135

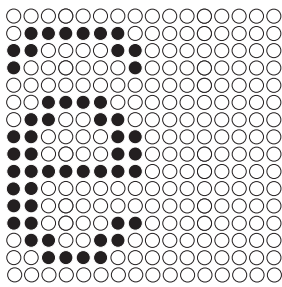

CHR136

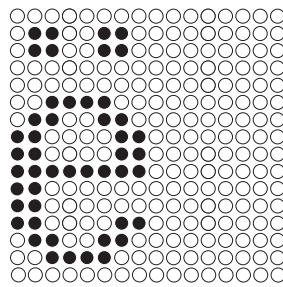

CHR137

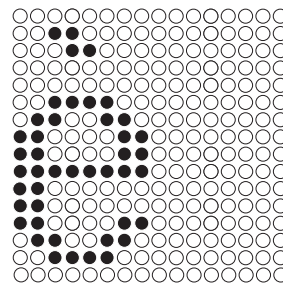

CHR138

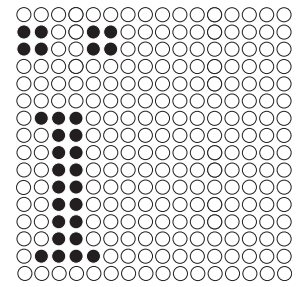

CHR139

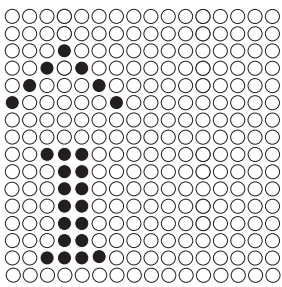

CHR140

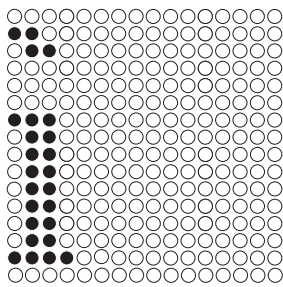

CHR141

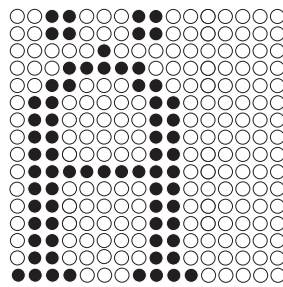

CHR142

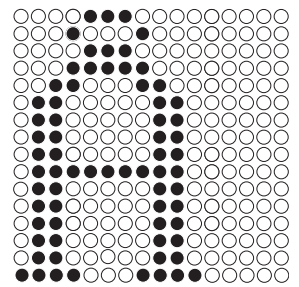

CHR143

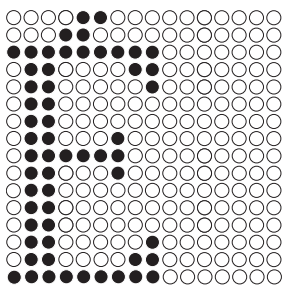

CHR144

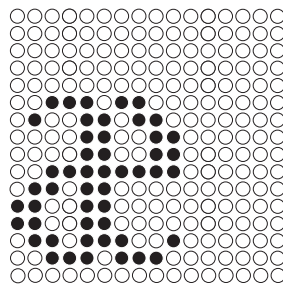

CHR145

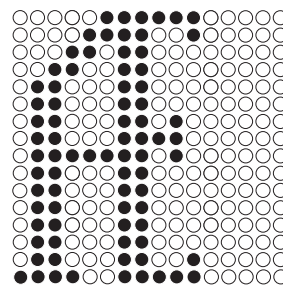

CHR146

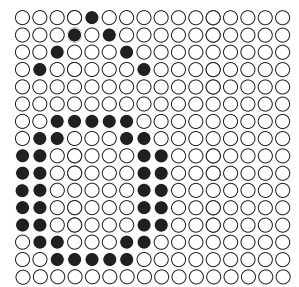

CHR147

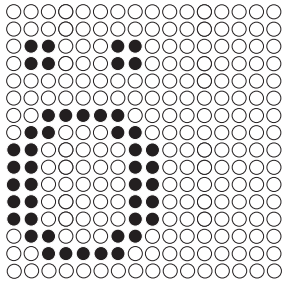

CHR148

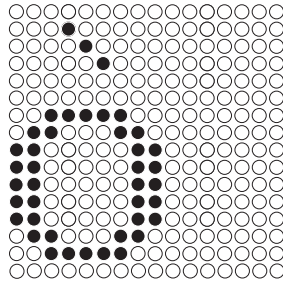

CHR149

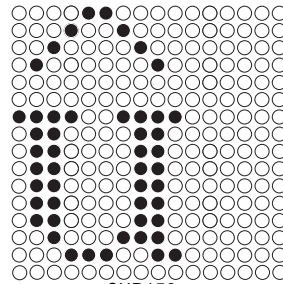

CHR150

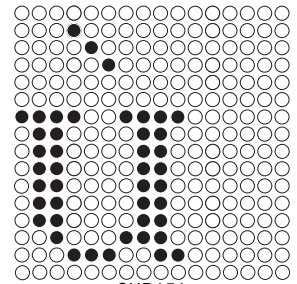

CHR151

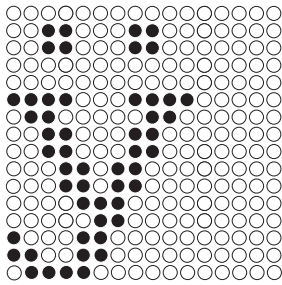

CHR152

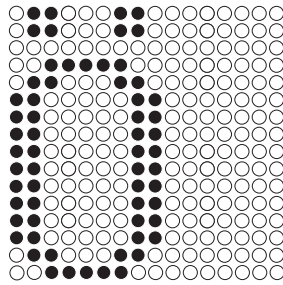

CHR153

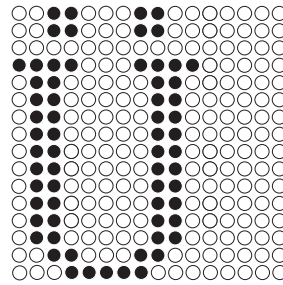

CHR154

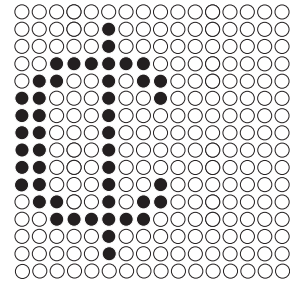

CHR155

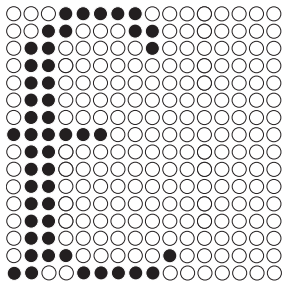

CHR156

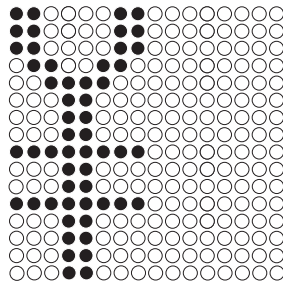

CHR157

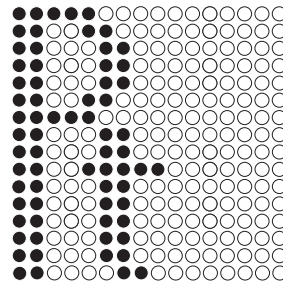

CHR158

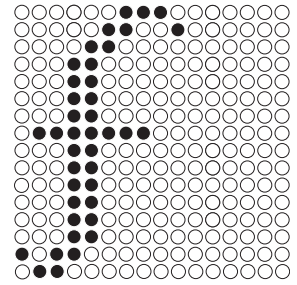

CHR159

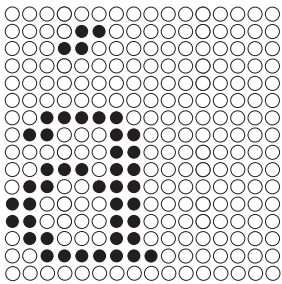

CHR160

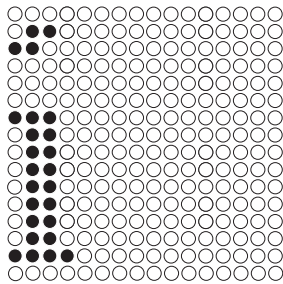

CHR161

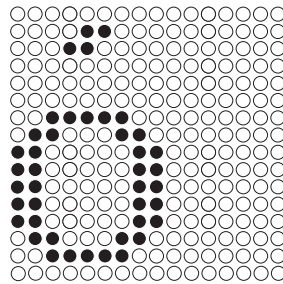

CHR162

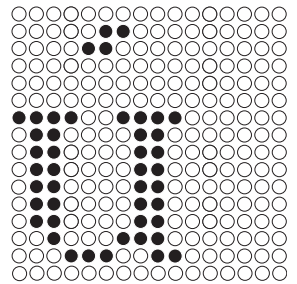

CHR163

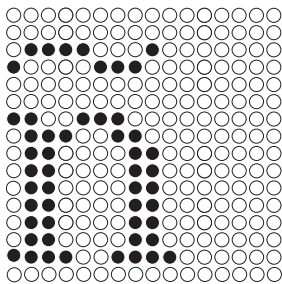

CHR164

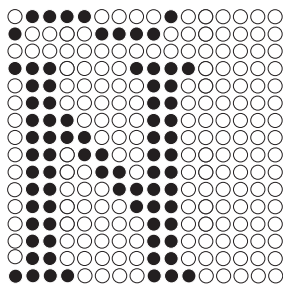

CHR165

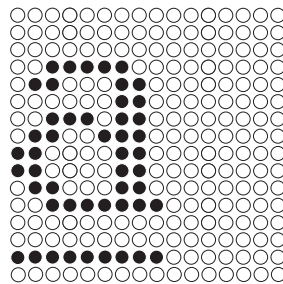

CHR166

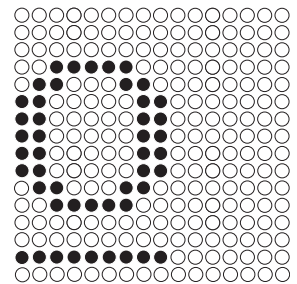

CHR167



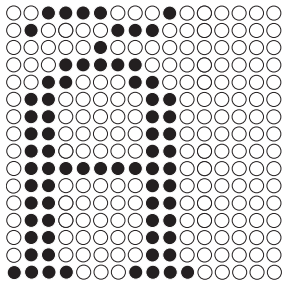

CHR188

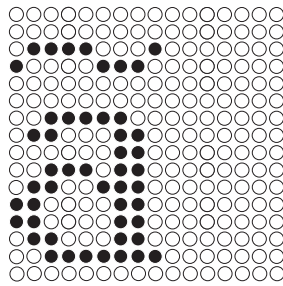

CHR189

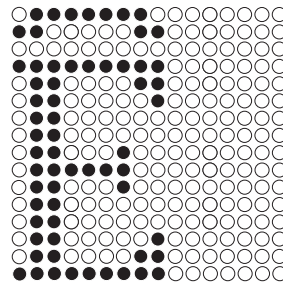

CHR190

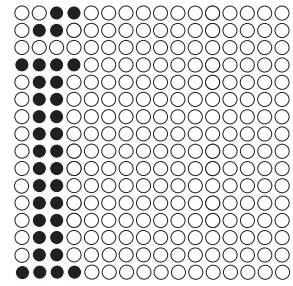

CHR191

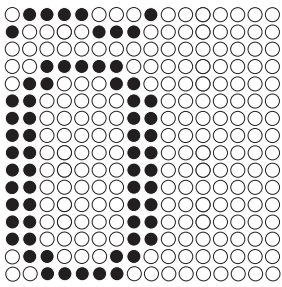

CHR192

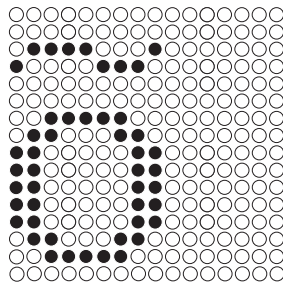

CHR193

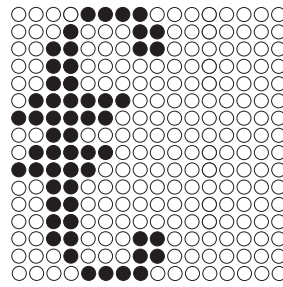

CHR194

### 7.15.18 16-High Fat Character

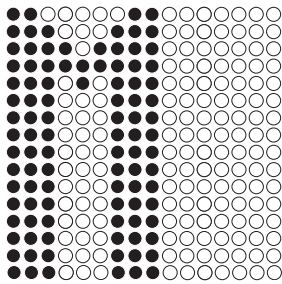

FATM

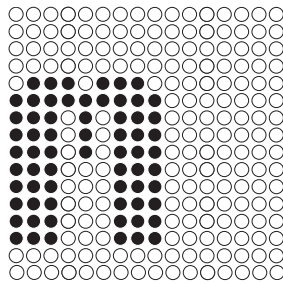

FATM1

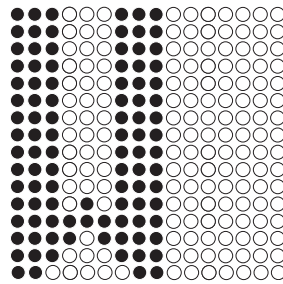

FATW

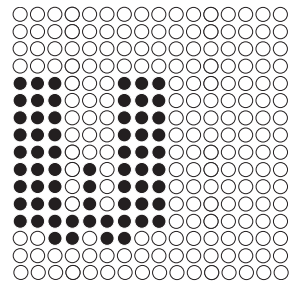

FATW1

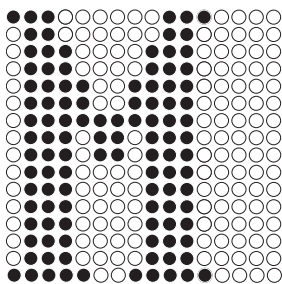

FFATM

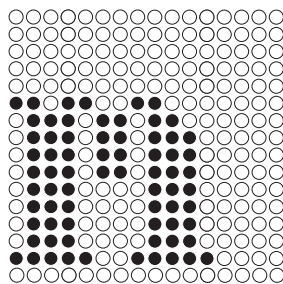

FFATM1

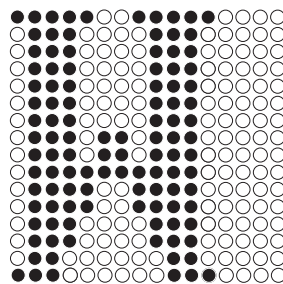

FFATW

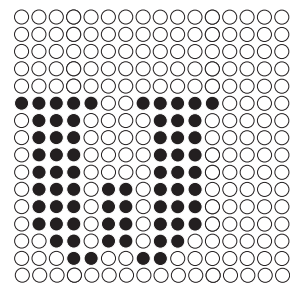

FFATW1